



US00D328915S

United States Patent [19]

[11] Patent Number: **Des. 328,915**

Sato

[45] Date of Patent: **** Aug. 25, 1992**

[54] ELECTRONIC DRUM

[75] Inventor: **Daizo Sato**, Hamamatsu, Japan

[73] Assignee: **Yamaha Corporation**, Shizuoka, Japan

[**] Term: **14 Years**

[21] Appl. No.: **540,502**

[22] Filed: **Jun. 19, 1990**

[30] Foreign Application Priority Data

Dec. 20, 1989 [JP] Japan 1-46461

[52] U.S. Cl. **D17/22**

[58] Field of Search **D17/22, 99; 84/723-733, DIG. 12, DIG. 14; D21/64**

[56] References Cited

U.S. PATENT DOCUMENTS

- D. 244,717 6/1977 Schneider et al. D17/22
- D. 316,422 4/1991 Mine D17/22
- D. 319,249 8/1991 Aluisi D17/22
- 4,479,412 10/1984 Klynas 84/DIG. 24

FOREIGN PATENT DOCUMENTS

- 665348 8/1985 Japan .
- 765025 3/1989 Japan .
- 765065 3/1989 Japan .

OTHER PUBLICATIONS

Best Store catalog, 1984-1985 p. 326 (Synsonics Electronic Drums, item 9).

Primary Examiner—Bernard Ansher
Assistant Examiner—Adir Aronovich
Attorney, Agent, or Firm—Weingarten, Schurgin, Gagnebin & Hayes

[57] CLAIM

The ornamental design for electronic drum, as shown.

DESCRIPTION

FIG. 1 is a top, front perspective view of an electronic drum showing my new design;
 FIG. 2 is a front elevational view thereof;
 FIG. 3 is a rear elevational view thereof;
 FIG. 4 is a top plan view thereof;
 FIG. 5 is a bottom plan view thereof;
 FIG. 6 is a left side elevational view; and,
 FIG. 7 is a right side elevational view.

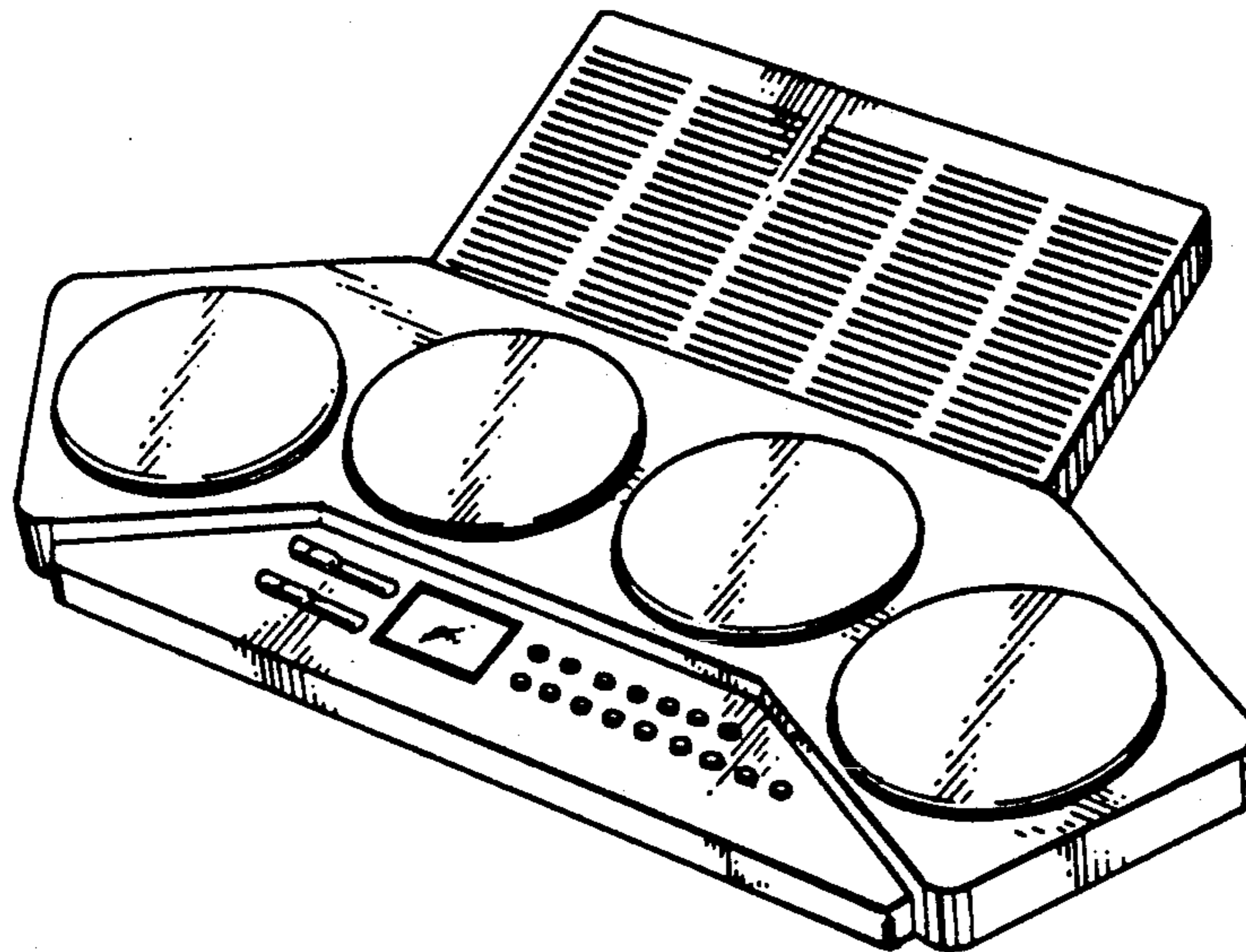

FIG. 1

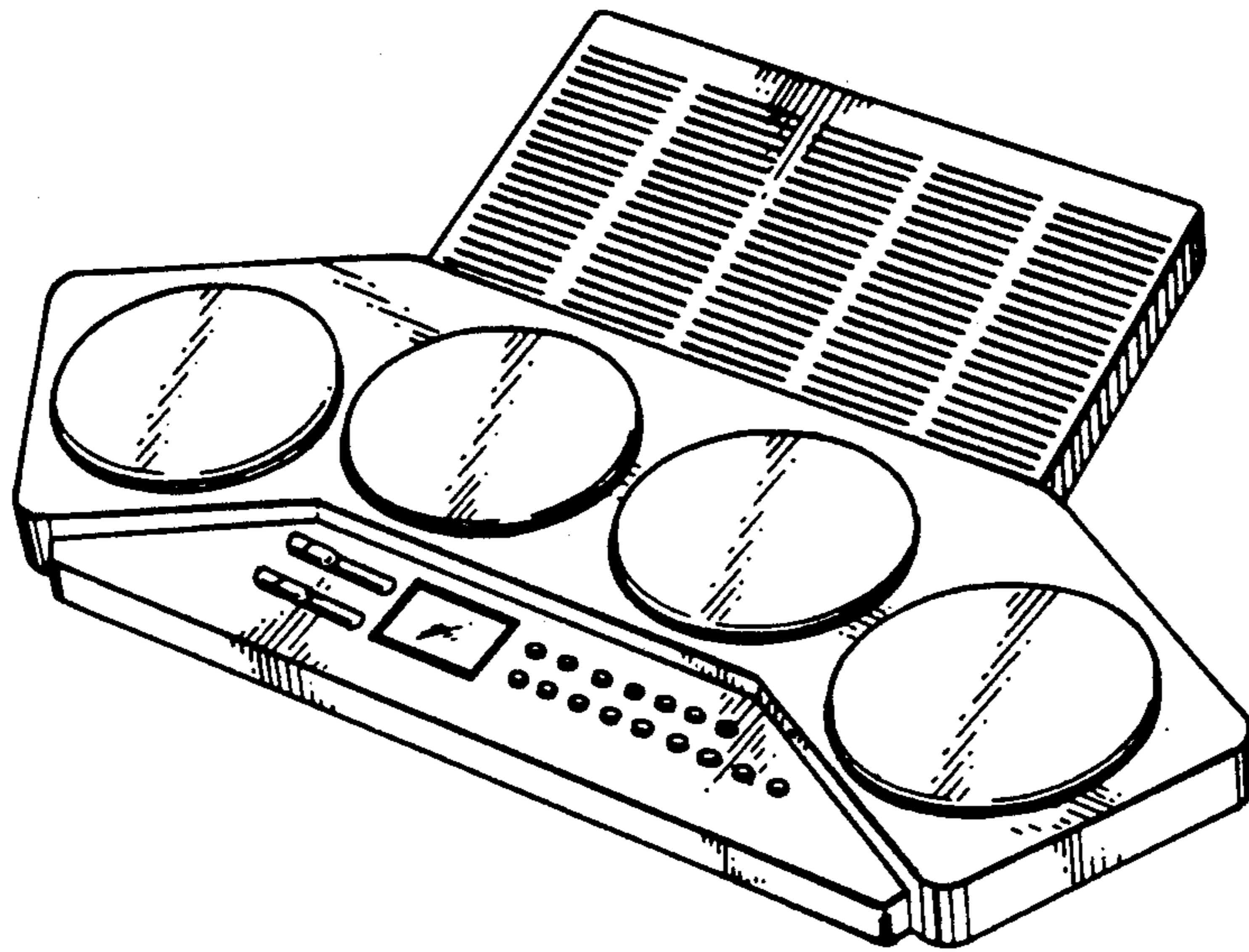

FIG. 2

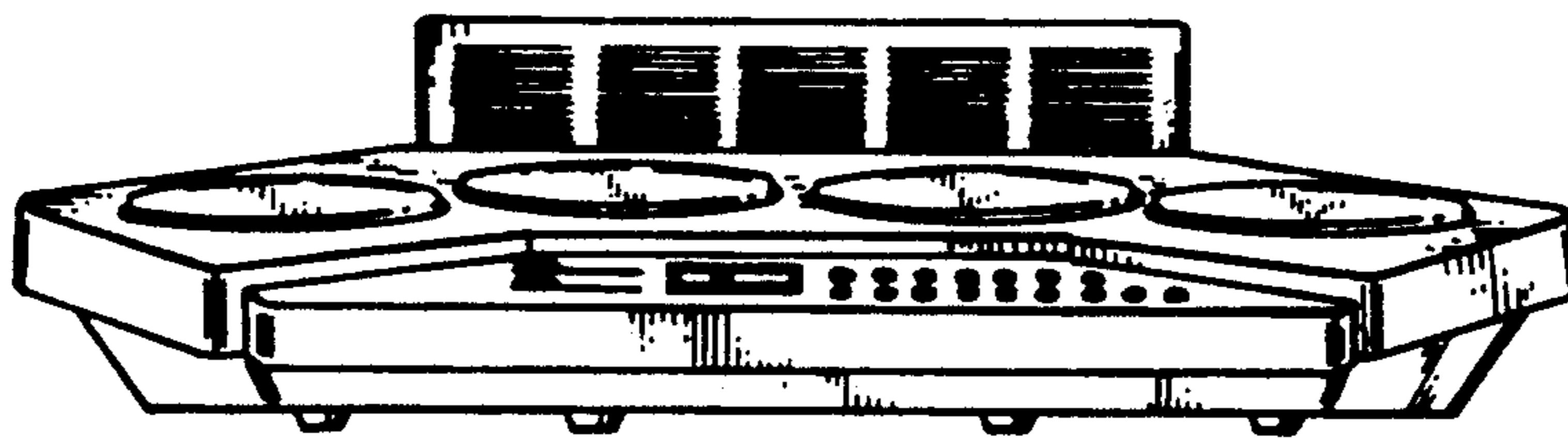

FIG. 3

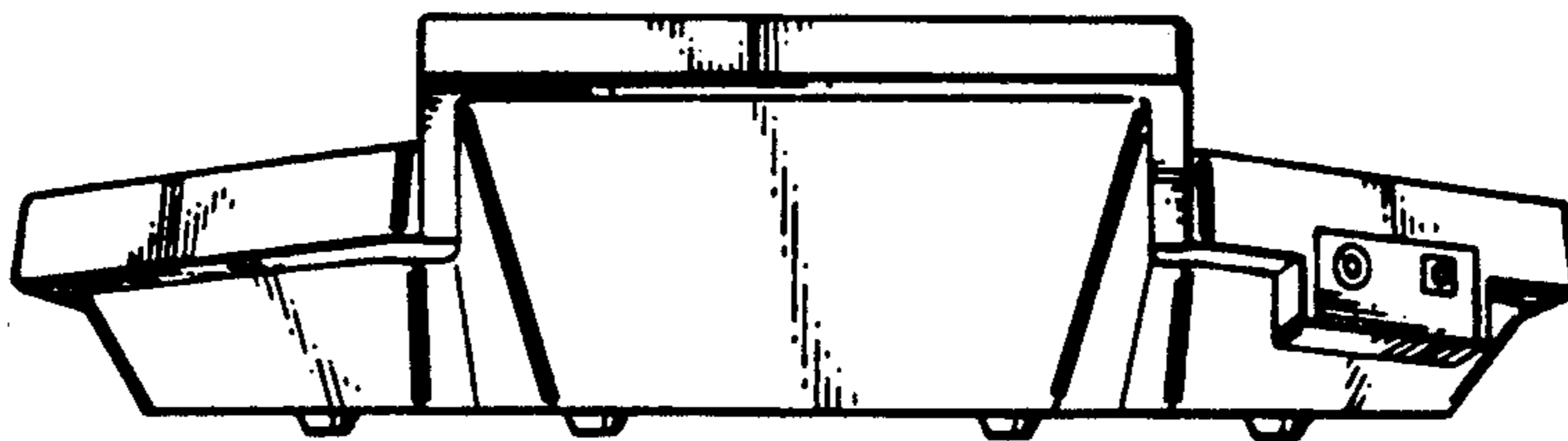

FIG.4

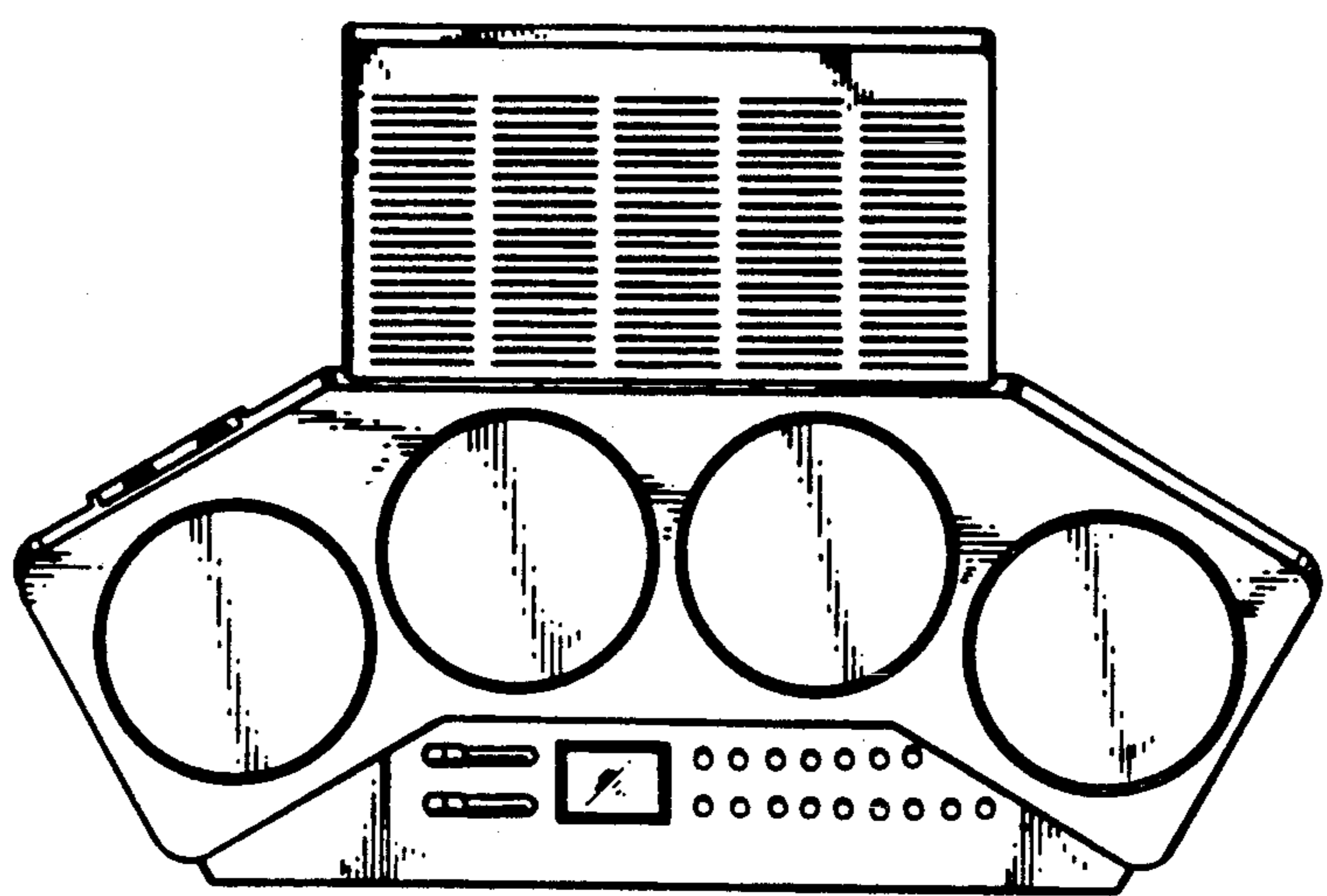

FIG.5

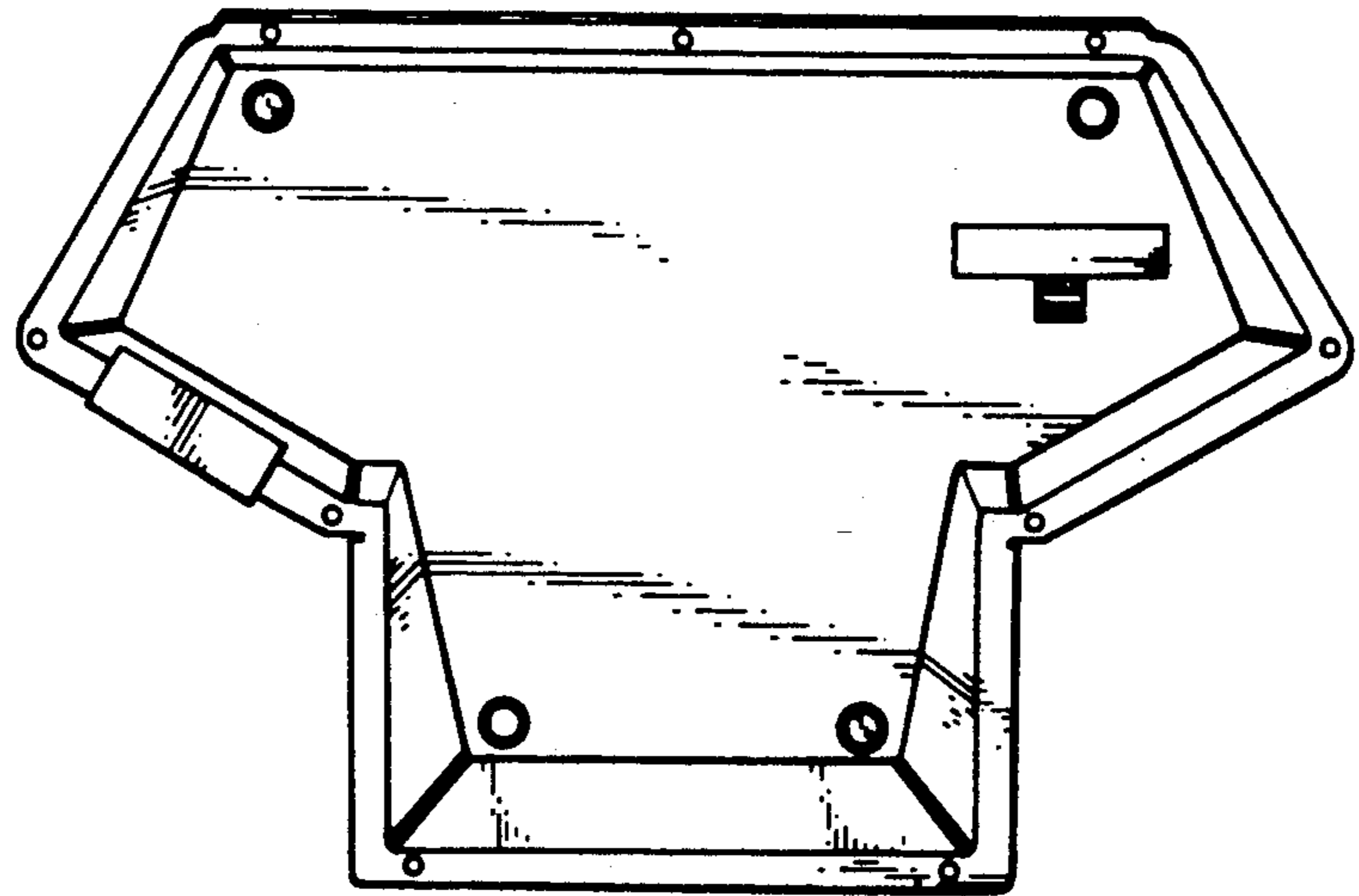

FIG.6

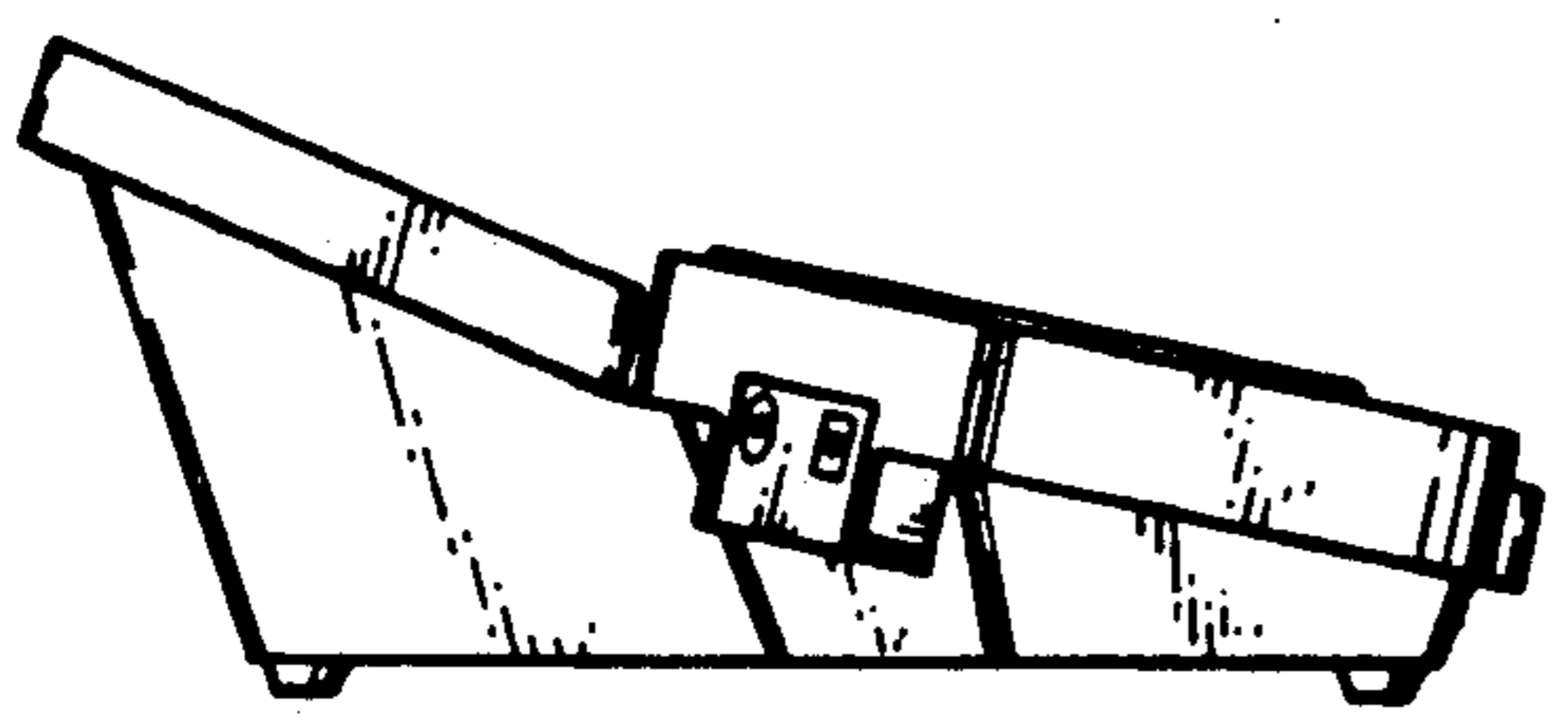
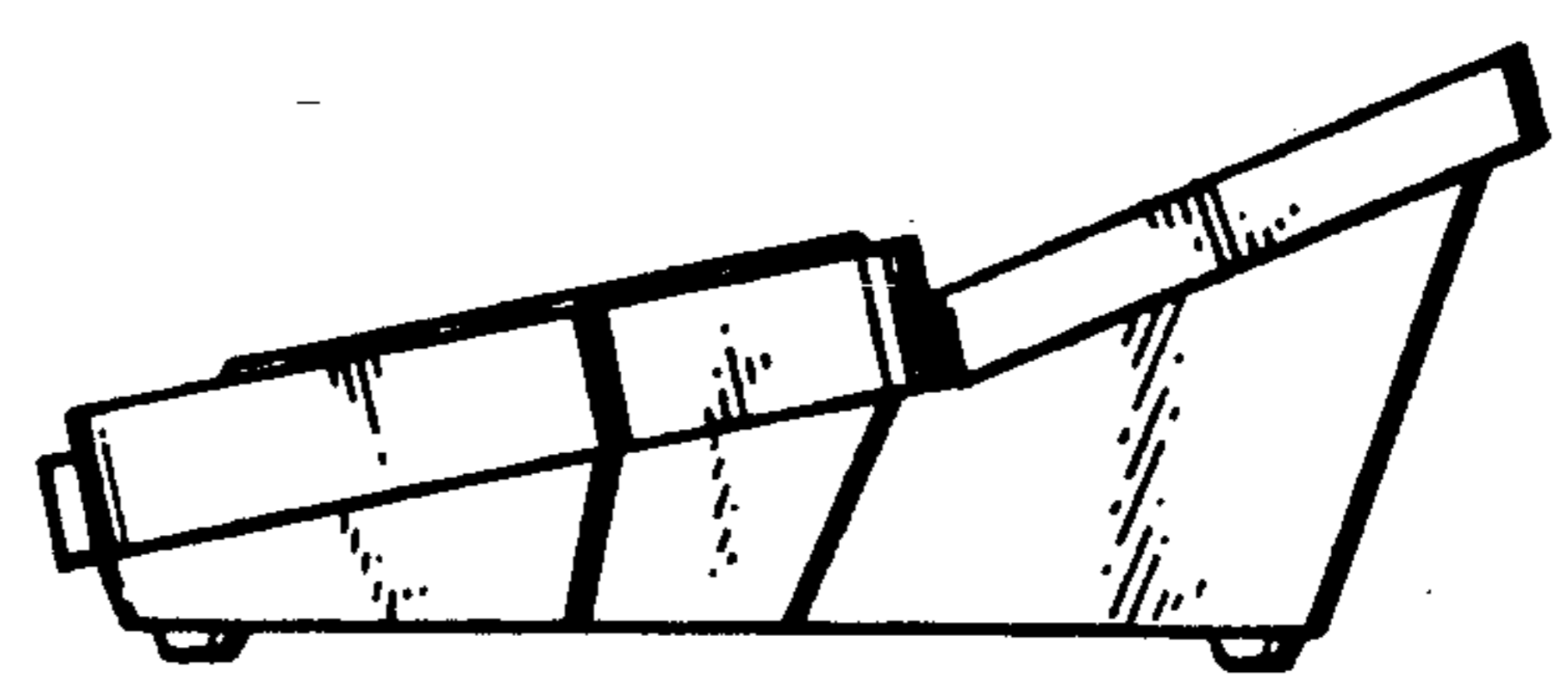

FIG.7



UNITED STATES PATENT AND TRADEMARK OFFICE
CERTIFICATE OF CORRECTION

PATENT NO. : Des. 328,915
DATED : August 25, 1992
INVENTOR(S) : Daizo Sato

It is certified that error appears in the above-identified patent and that said Letters Patent is hereby corrected as shown below:

On the title page, item (73) Assignee, city should read--Shizuoka-ken--.

Signed and Sealed this
Fifth Day of April, 1994



BRUCE LEHMAN

Commissioner of Patents and Trademarks

Attest:

Attesting Officer