



US00D328865S

United States Patent [19]

[11] Patent Number: **Des. 328,865**

Crawford et al.

[45] Date of Patent: **** Aug. 25, 1992**

[54] **COMBINED BOTTLE AND CAP**
 [75] Inventors: **John C. Crawford, Lake Mahopac, N.Y.; Althea A. Lee, Hoboken, N.J.**
 [73] Assignee: **Colgate-Palmolive Company, New York, N.Y.**

D. 284,352 6/1986 Thompson D9/377 X
 D. 290,231 6/1987 Durand D9/384
 2,216,900 10/1940 Bertino 120/69
 2,689,665 9/1954 Martin 215/43
 3,366,284 1/1968 Marona et al. 222/211
 3,409,181 11/1968 McDonnell 222/211
 4,093,096 6/1978 Augros 215/330

[**] Term: **14 Years**

Primary Examiner—Bernard Ansher
Assistant Examiner—Lucy Lieberman
Attorney, Agent, or Firm—Richard J. Ancel; Robert C. Sullivan

[21] Appl. No.: **544,785**

[22] Filed: **Jun. 27, 1990**

[52] U.S. Cl. **D9/529**

[58] Field of Search **D9/377, 403-413, D9/389; 215/1 R, 1 C; 222/206, 215**

[57] CLAIM

The ornamental design for a combined bottle and cap, as shown and described.

[56] References Cited

DESCRIPTION

U.S. PATENT DOCUMENTS

D. 86,724 4/1932 Joseph D9/377
 D. 97,681 12/1935 Larsen D9/400
 D. 202,662 10/1965 Williams D9/377
 D. 204,710 5/1966 Roberts D9/412
 D. 207,511 4/1967 Riordan et al. D9/377
 D. 234,900 4/1975 Achenback D9/399
 D. 236,586 9/1975 McDonald D9/413
 D. 257,125 9/1980 Smali D9/410
 D. 261,865 11/1981 Davis et al. D9/389

FIG. 1 is a front side elevational view of a combined bottle and cap embodying our new design;
 FIG. 2 is a left side elevational view thereof;
 FIG. 3 is a rear elevational view thereof;
 FIG. 4 is a right side elevational view thereof;
 FIG. 5 is a top plan view thereof;
 FIG. 6 is a bottom plan view thereof;
 FIG. 7 is a perspective view thereof; and,
 FIG. 8 is an exploded perspective view thereof.

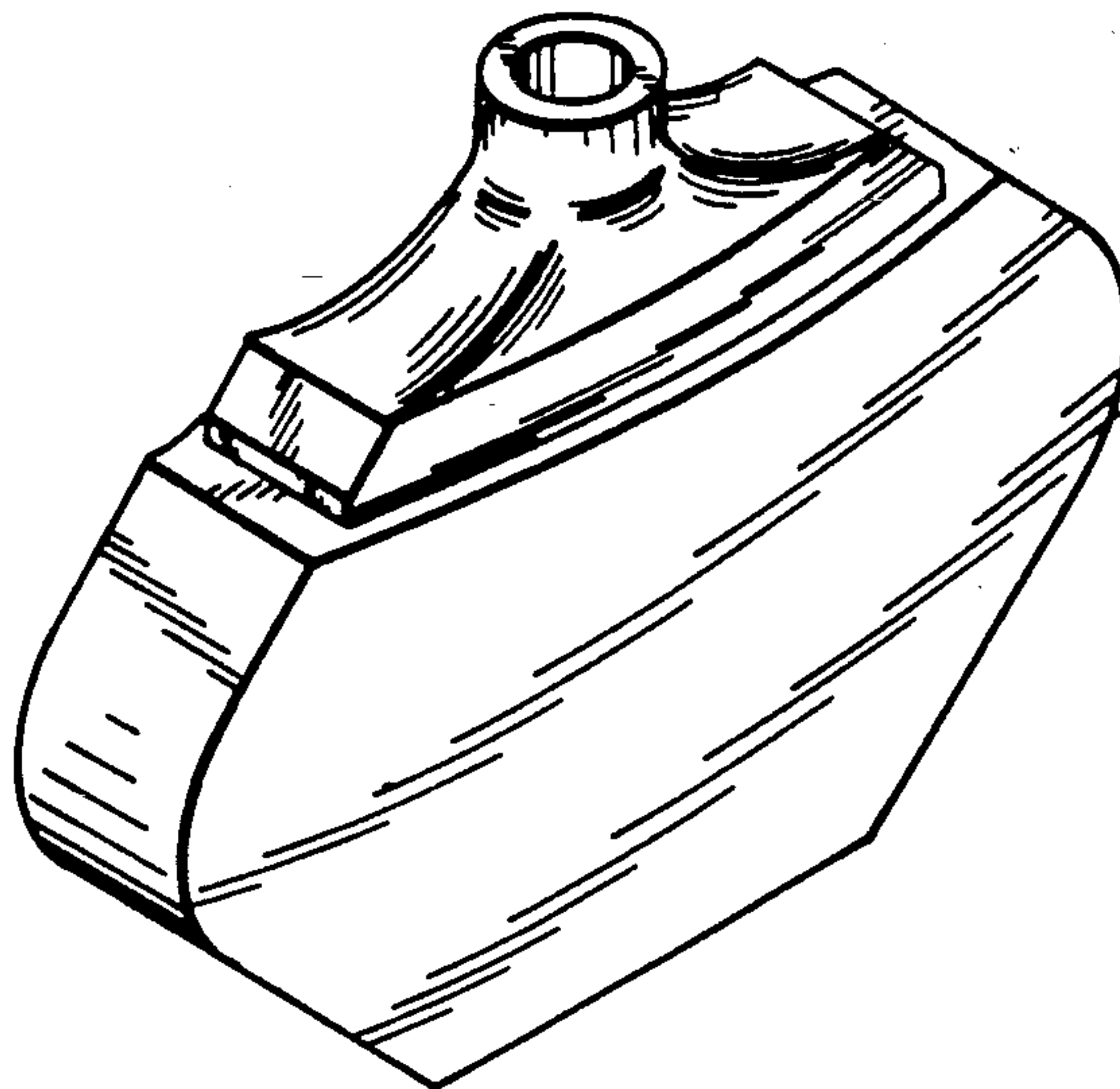
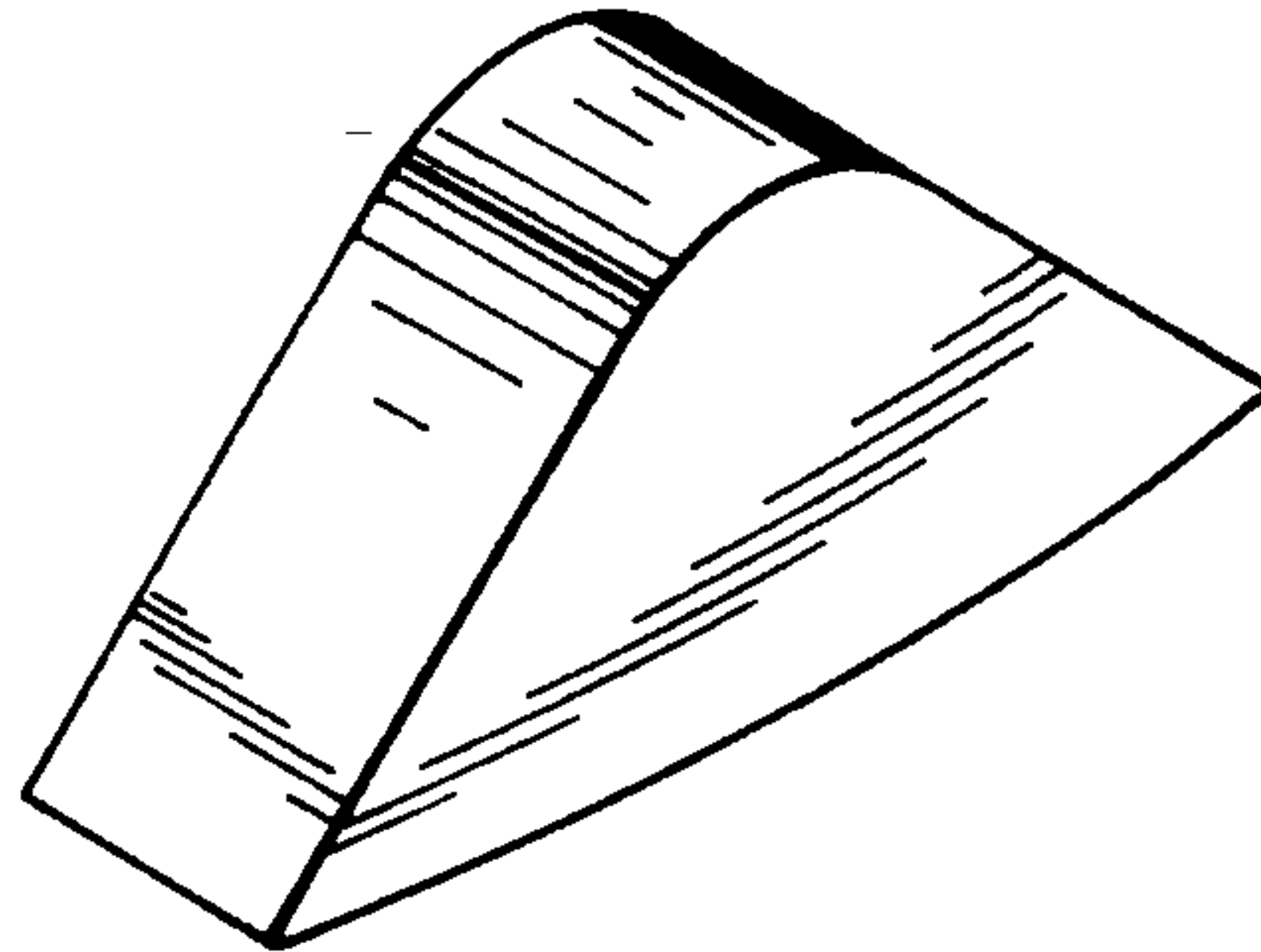

FIG. 1

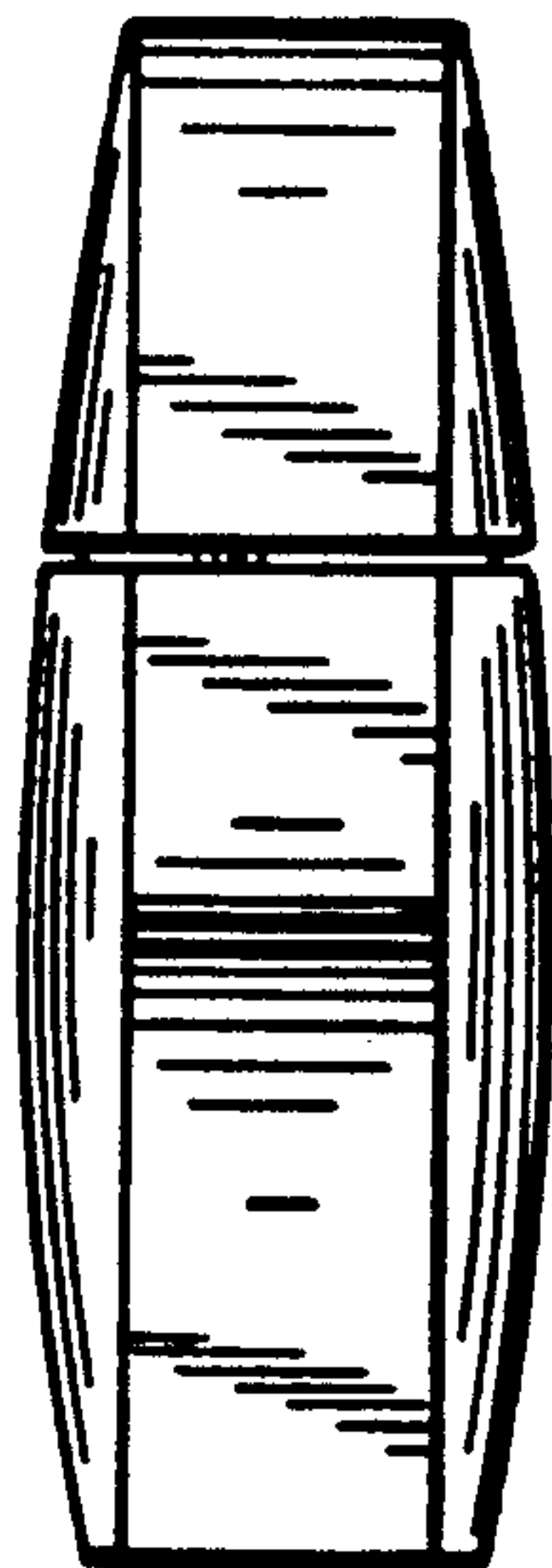
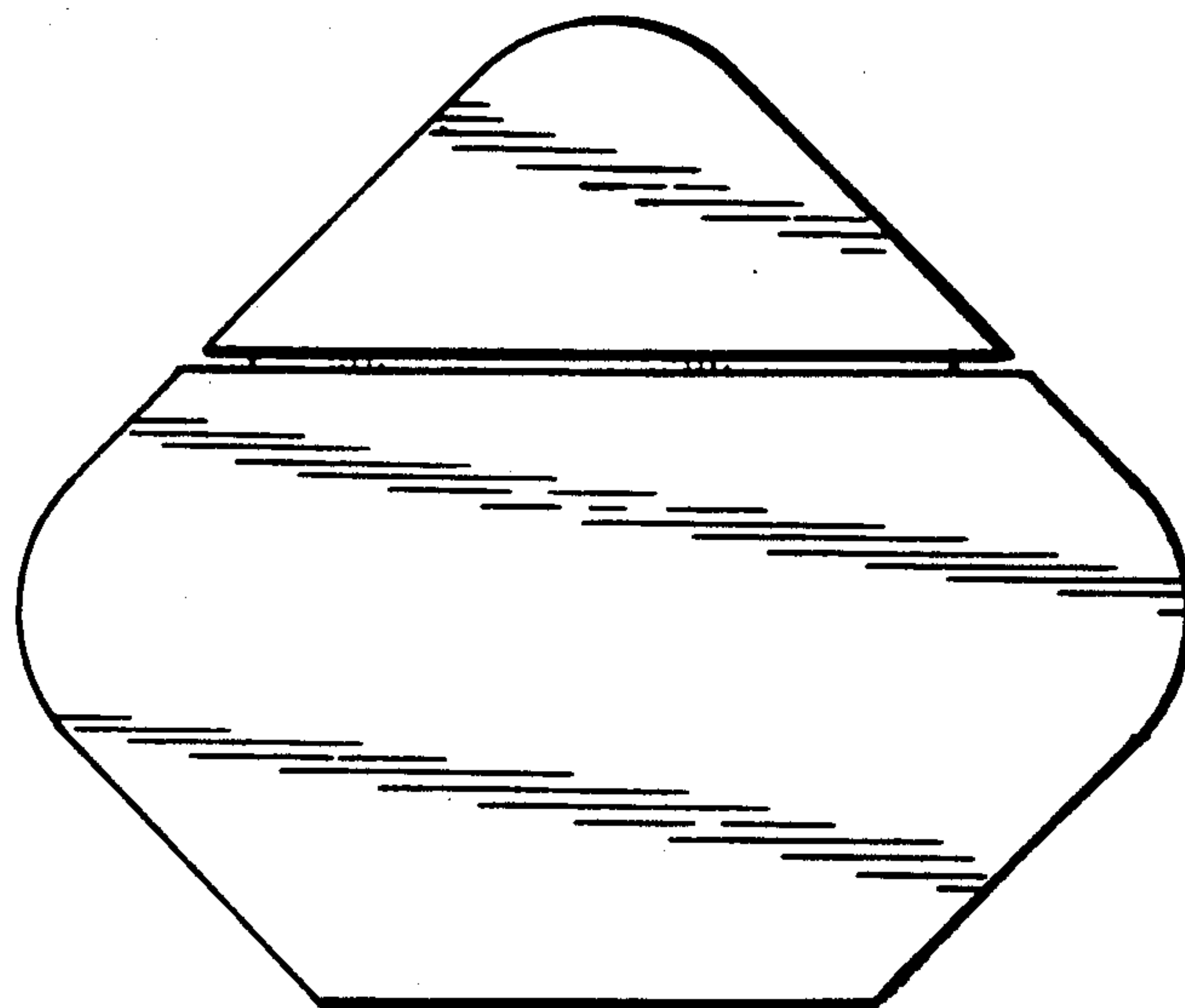

FIG. 2

FIG. 3

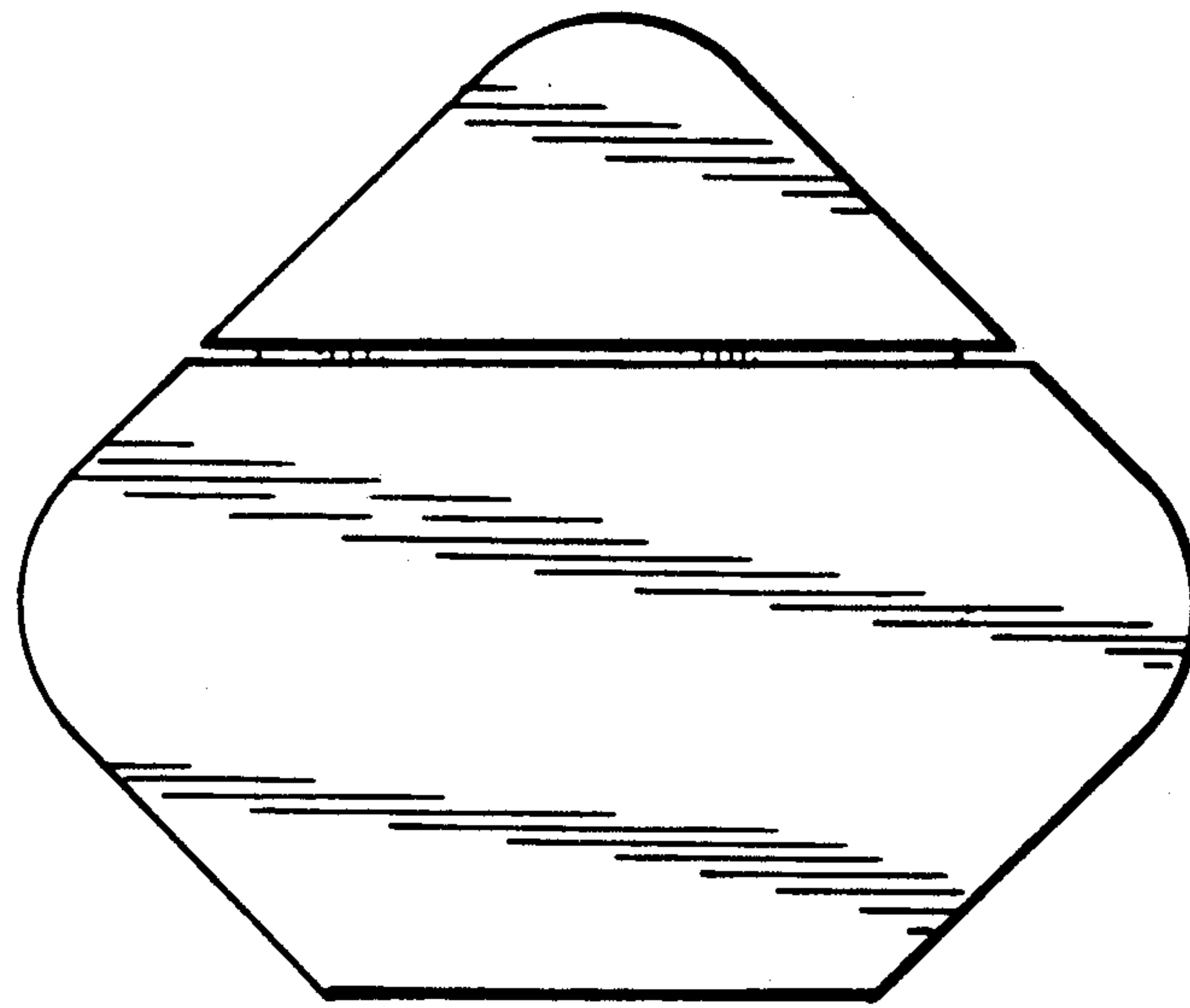

FIG. 4

FIG. 5

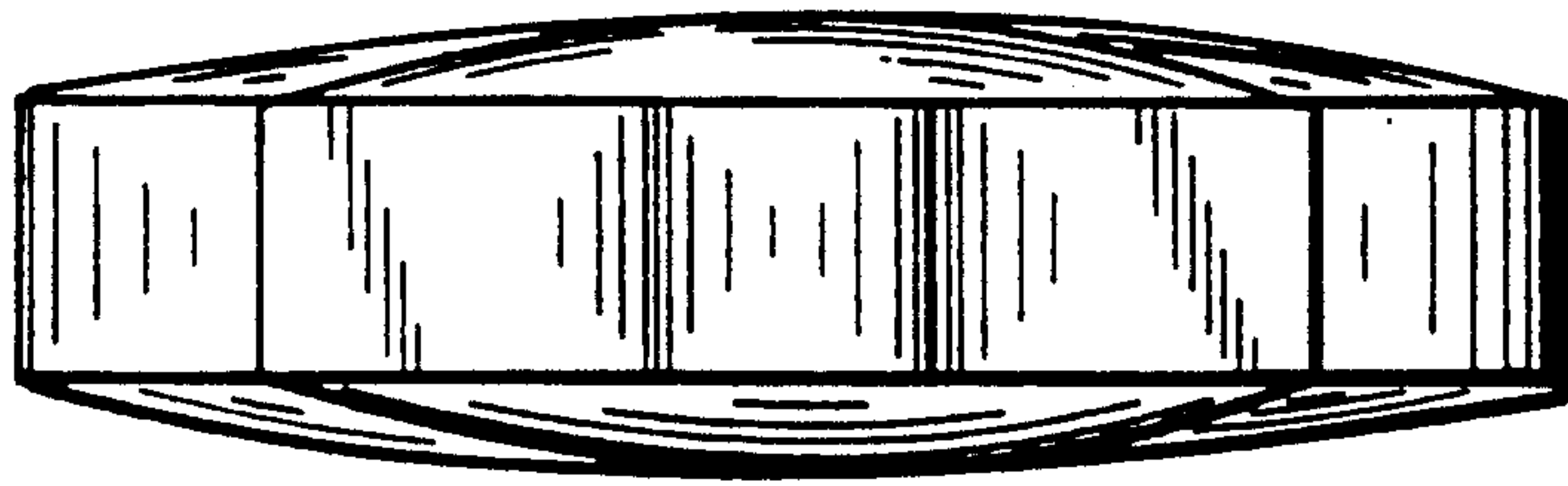

FIG. 6

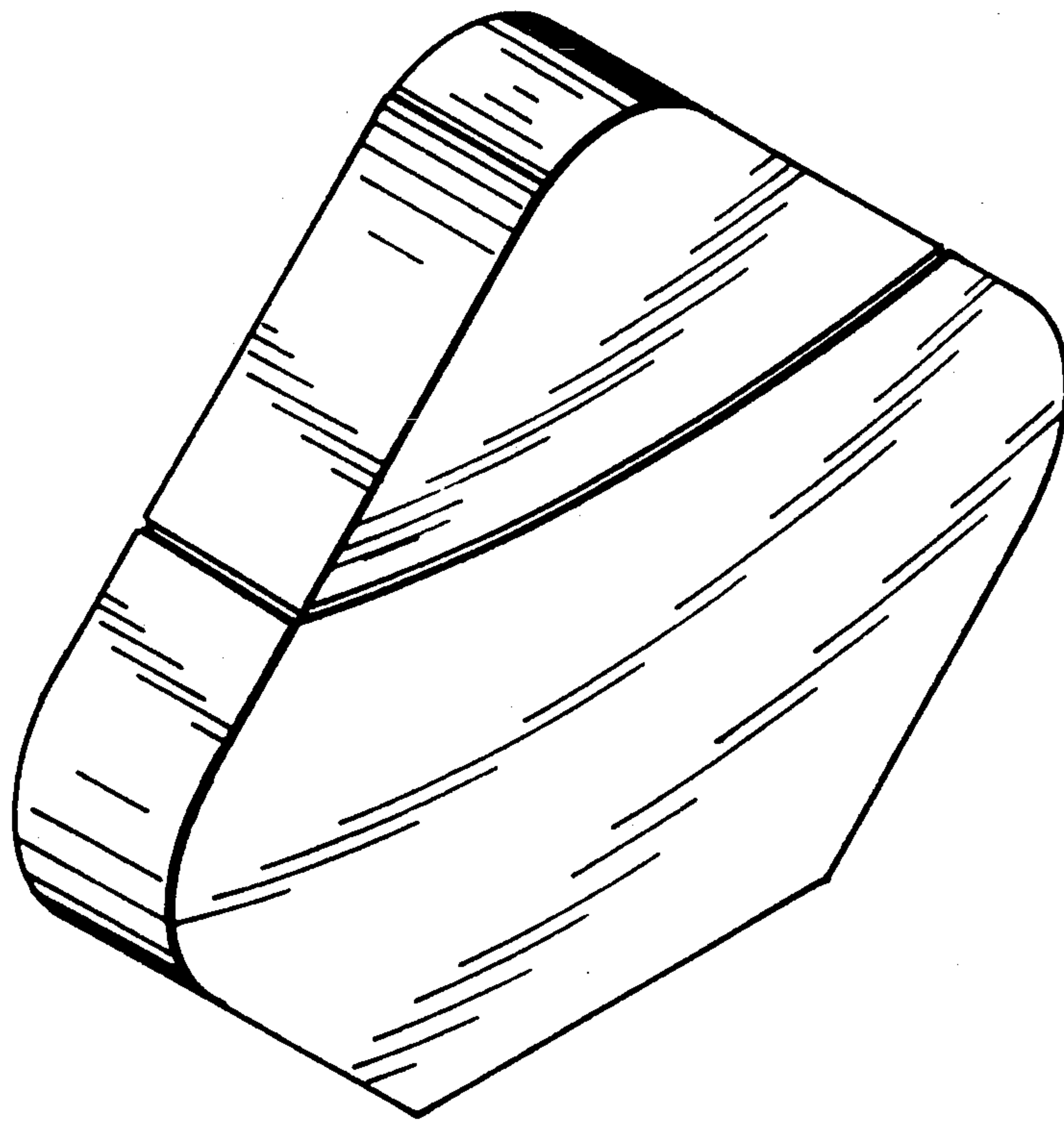

FIG. 7

FIG. 8

