



US00D328817S

United States Patent [19]
Holland

[11] **Patent Number: Des. 328,817**

[45] **Date of Patent: ** Aug. 25, 1992**

[54] **JEWELRY CHEST**

[76] **Inventor: Charles L. Holland, 8512A Yellow Springs Rd., Frederick, Md. 21701**

[**] **Term: 14 Years**

[21] **Appl. No.: 327,141**

[22] **Filed: Mar. 22, 1989**

[52] **U.S. Cl. D3/75; D3/74; D3/66**

[58] **Field of Search D3/106, 99, 30.1, 66, D3/75, 74; D6/436, 444, 445, 455; D11/80; 206/827, 45; 312/324, 204, 201, 270, 326; 108/94, 139, 103, 111; D9/341**

[56] **References Cited**

U.S. PATENT DOCUMENTS

D. 259,153	5/1981	Valente	D3/66
D. 288,878	3/1987	Munson	D6/455
D. 306,238	2/1990	Pham-Phu	D6/444 X
837,176	11/1906	Beasley	312/324
1,831,401	11/1931	Weidlich et al.	312/324
2,533,102	12/1950	Gifford	312/324 X
2,775,498	12/1956	Gettel	312/201
3,087,770	4/1963	Gettel	312/270
3,202,470	8/1965	Lage	312/324
3,392,868	7/1968	Pfrommer	312/201 X
4,239,308	12/1980	Bradley	312/201

Primary Examiner—A. Hugo Word

Assistant Examiner—M. N. Pandozzi
Attorney, Agent, or Firm—Eugene F. Osborne, Sr.

[57] **CLAIM**

The ornamental design for a jewelry chest, as shown and described.

DESCRIPTION

FIG. 1 is a top front perspective view of a jewelry chest showing my new design in closed position;
 FIG. 2 is a rear perspective view thereof;
 FIG. 3 is a top, front perspective view thereof in open position;
 FIG. 4 is a top plan view thereof in closed position;
 FIG. 5 is a front elevational view thereof;
 FIG. 6 is a rear elevational view thereof;
 FIG. 7 is a right side elevational view, the left side being a mirror image thereof;
 FIG. 8 is a front elevational view of a jewelry chest showing a second embodiment of my new design;
 FIG. 9 is a top front perspective view thereof in open position;
 FIG. 10 is a top plan view thereof, in closed position;
 FIG. 11 is a front elevational view thereof;
 FIG. 12 is a rear elevational view thereof; and,
 FIG. 13 is a right side elevational view in open position the left side being a mirror image thereof.
 The bottom of both embodiments are plain and unornamented.

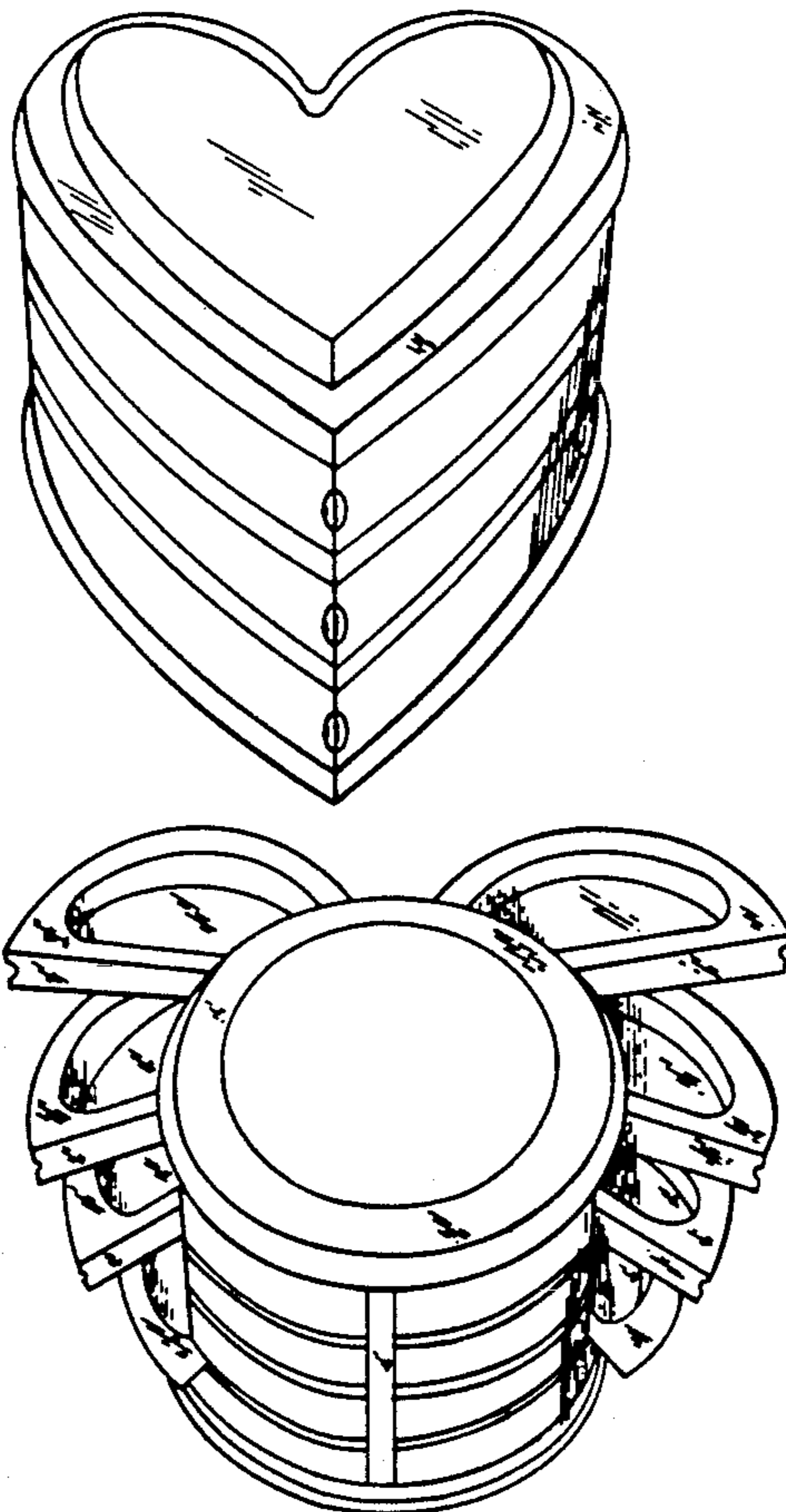

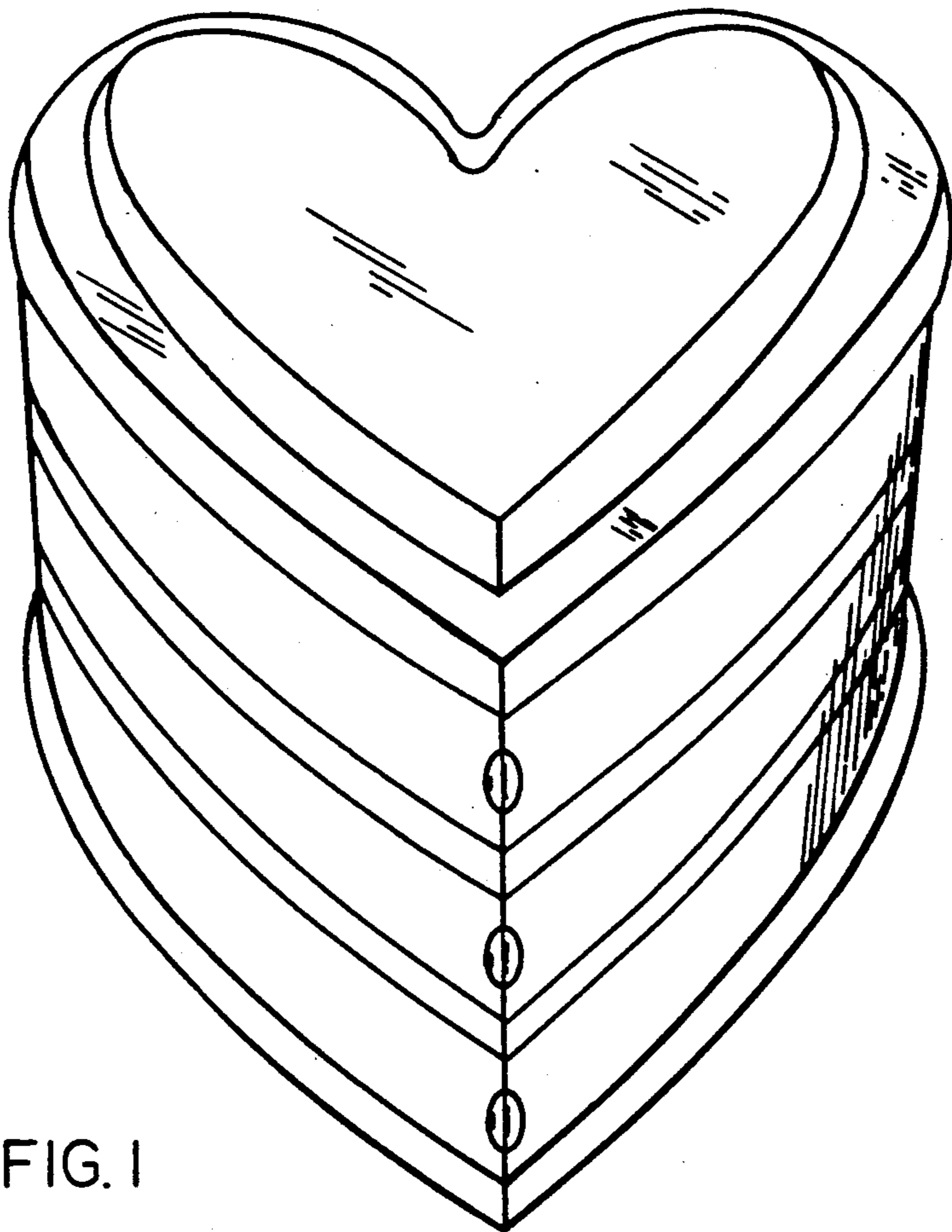

FIG. 1

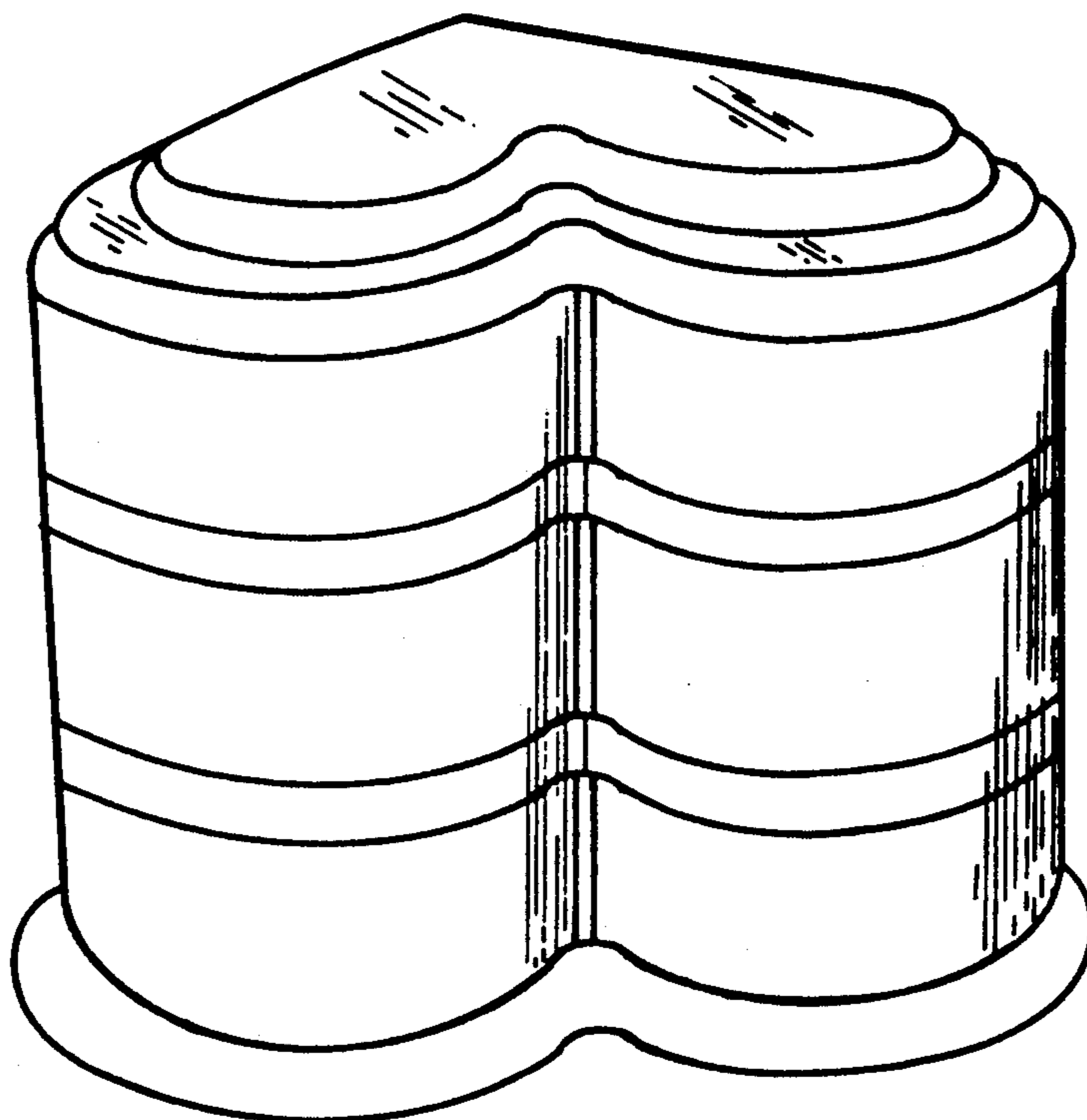

FIG. 2

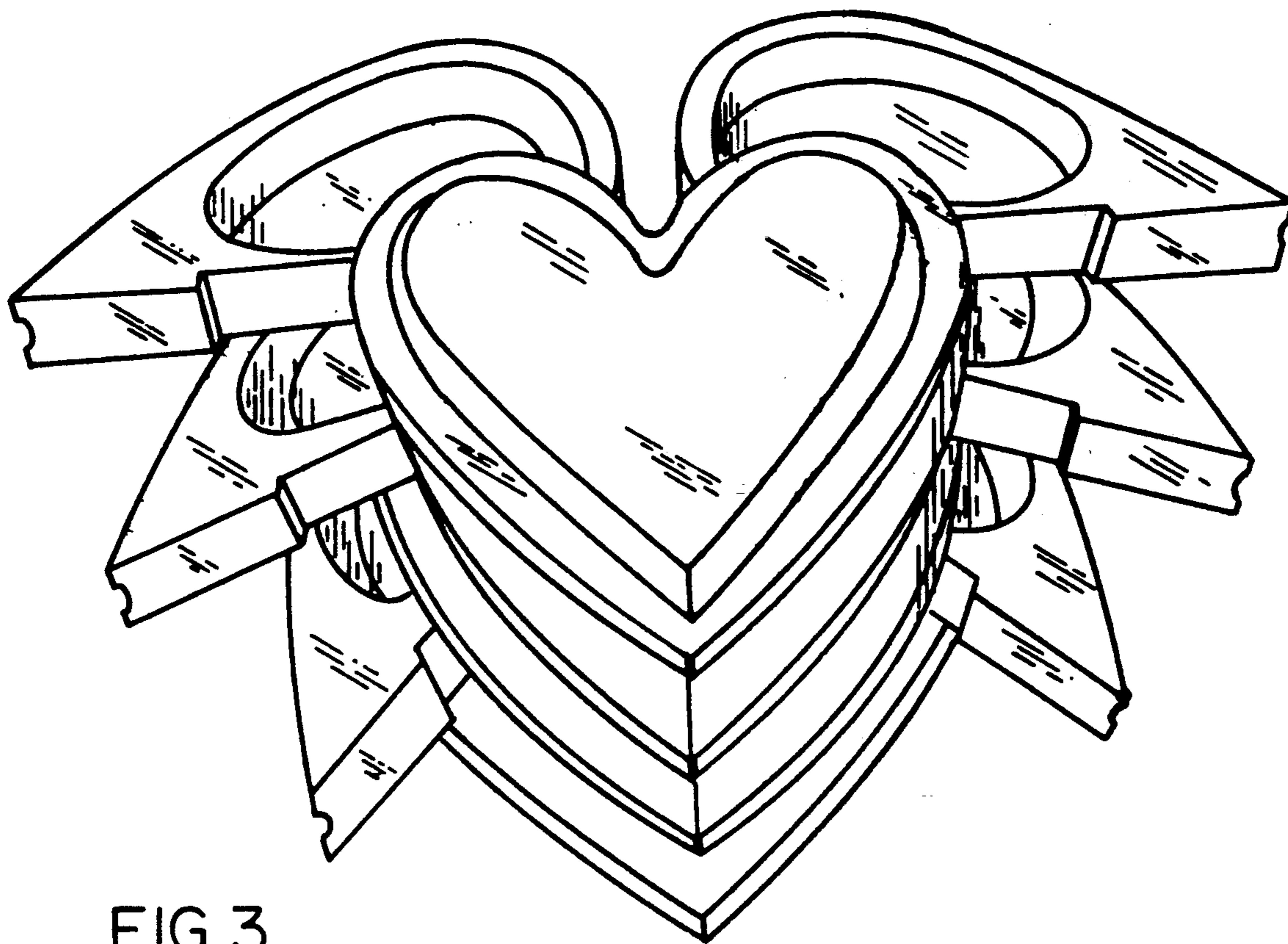

FIG. 3

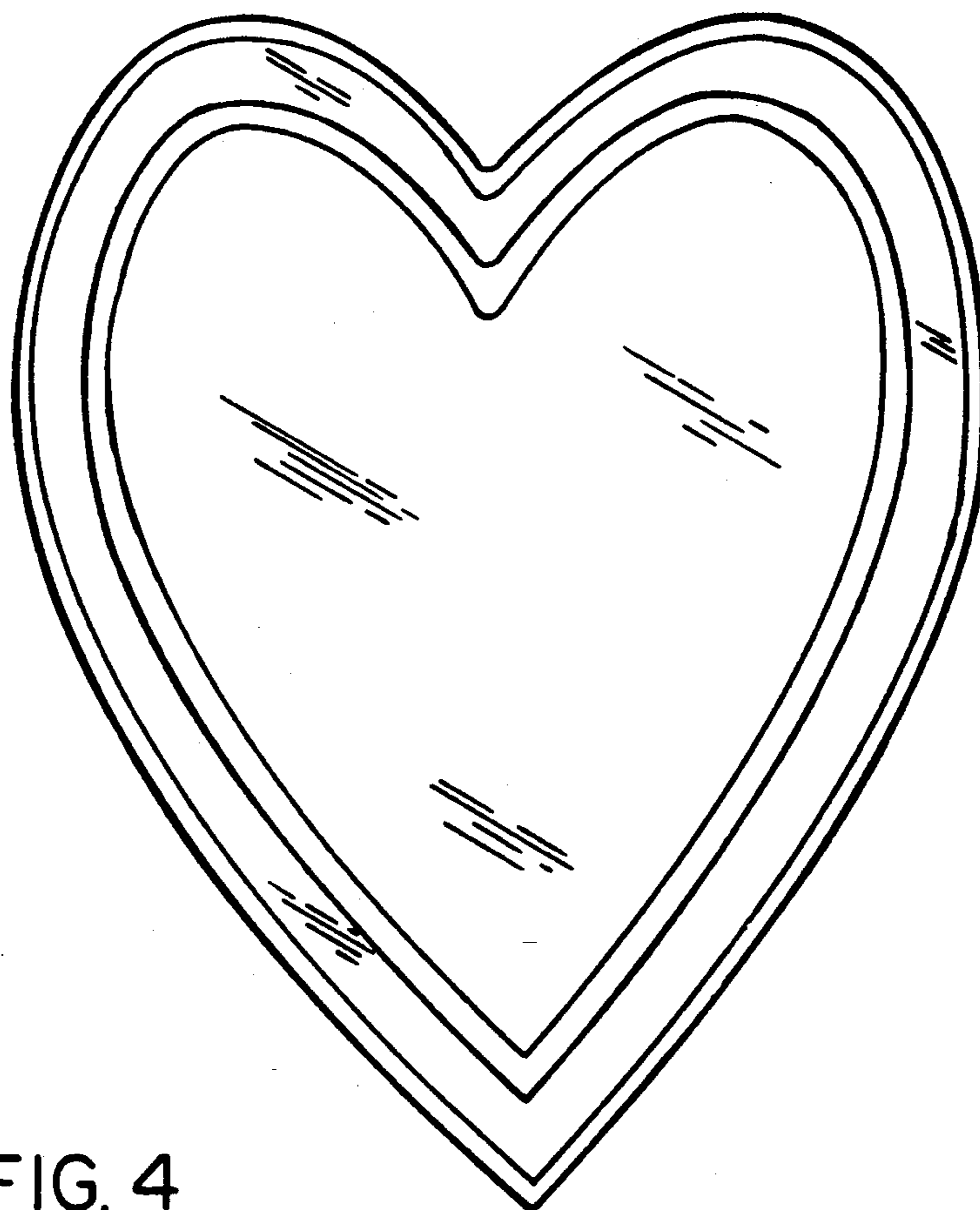

FIG. 4

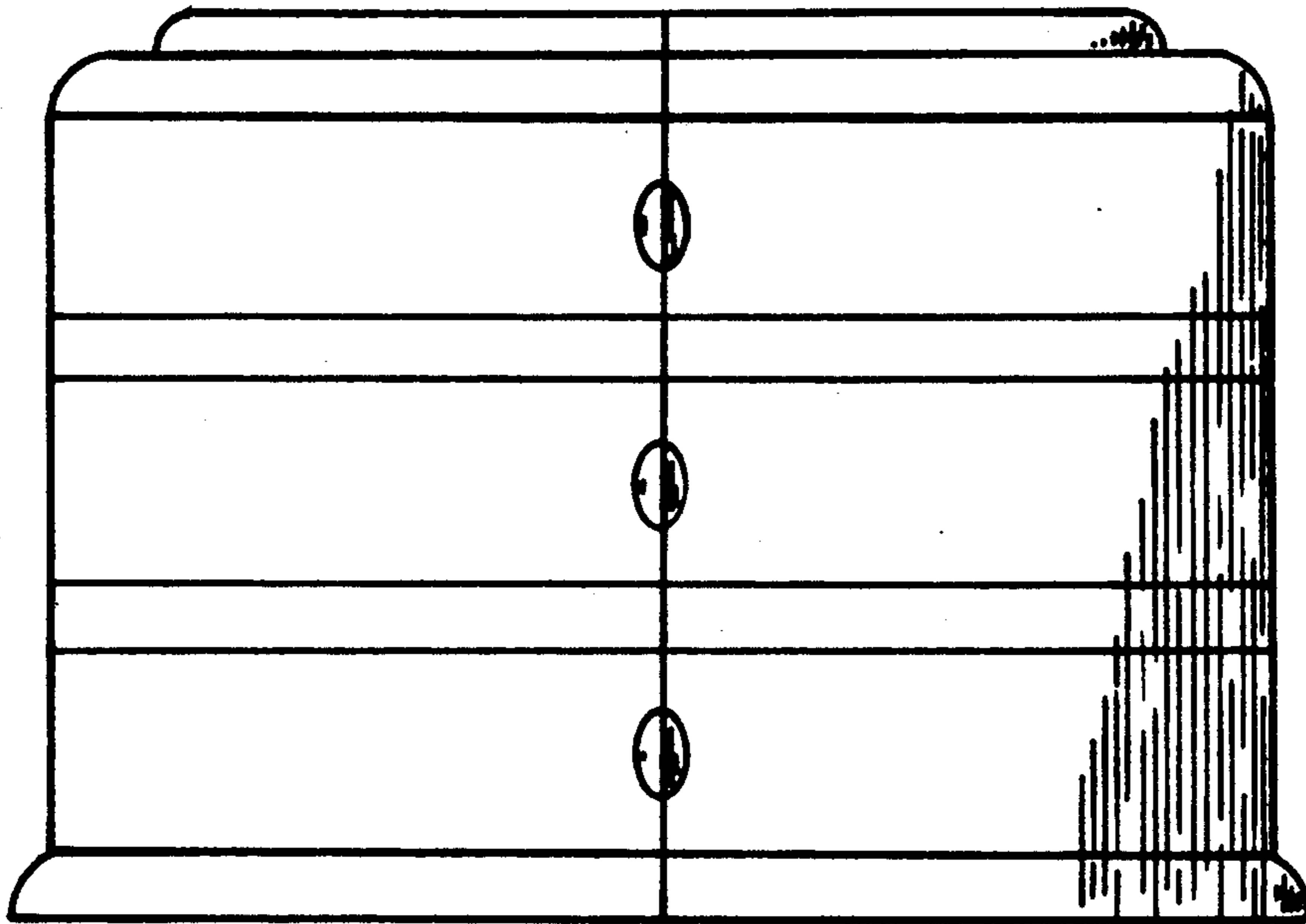

FIG. 5

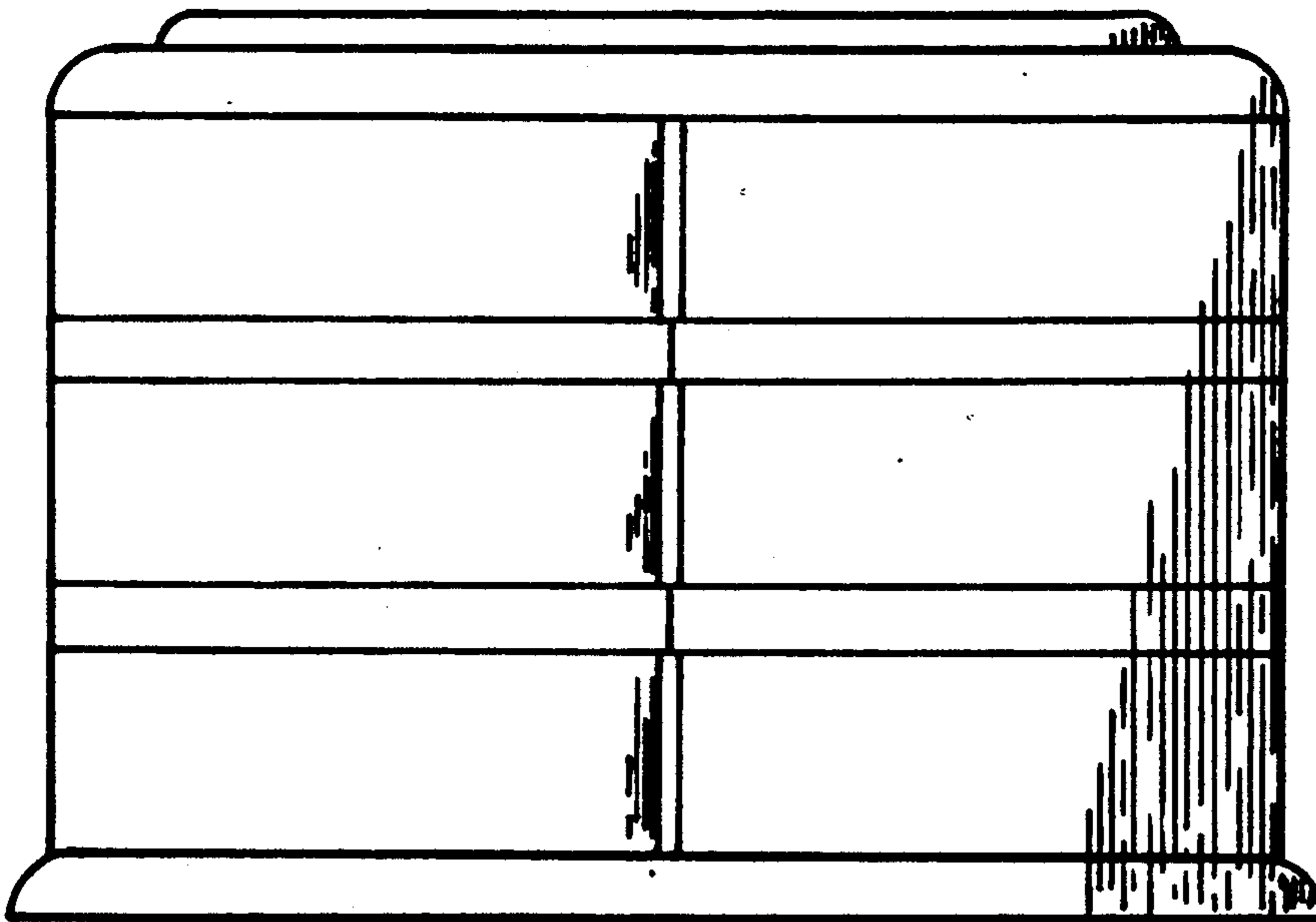

FIG. 6

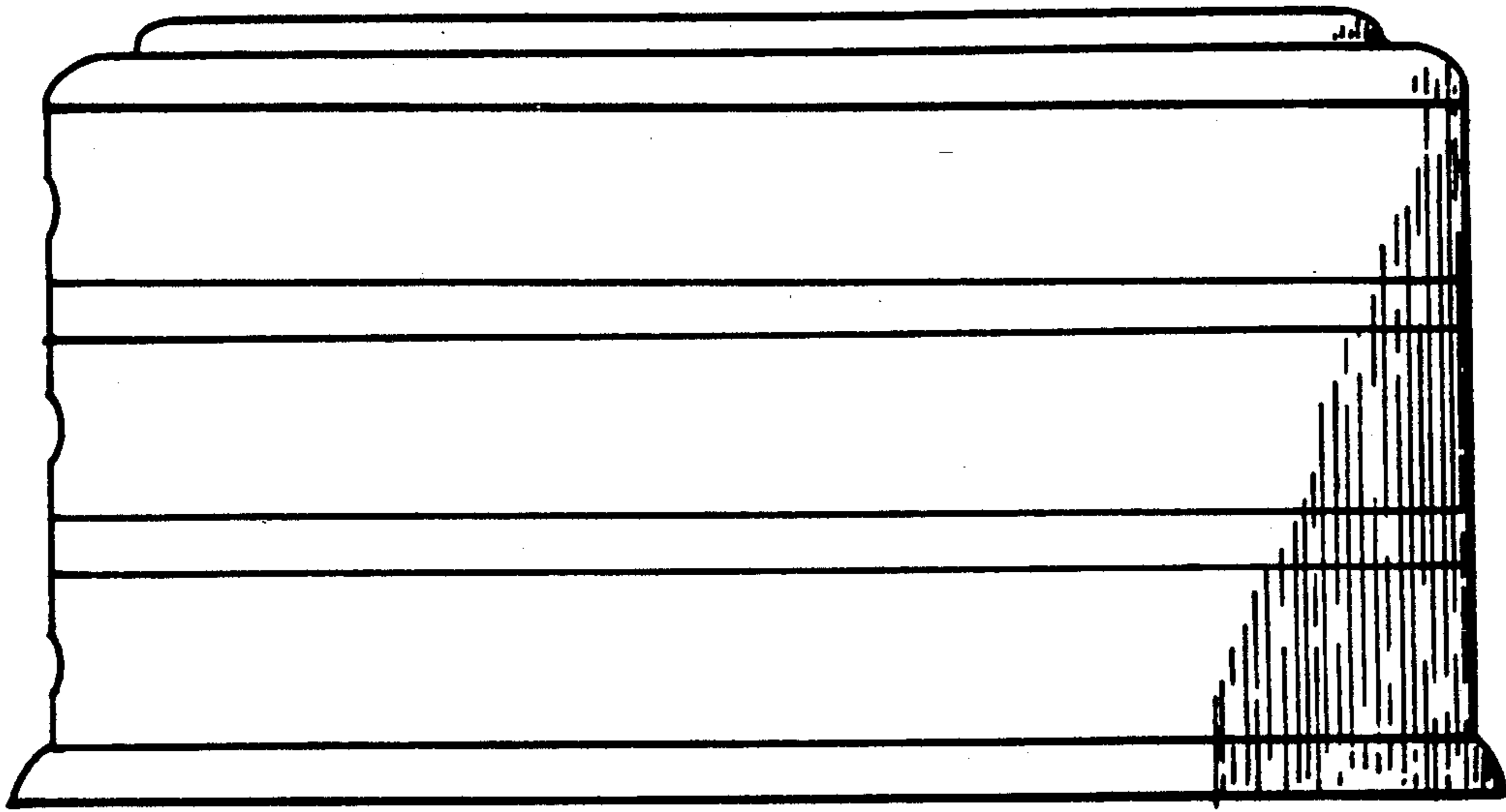

FIG. 7

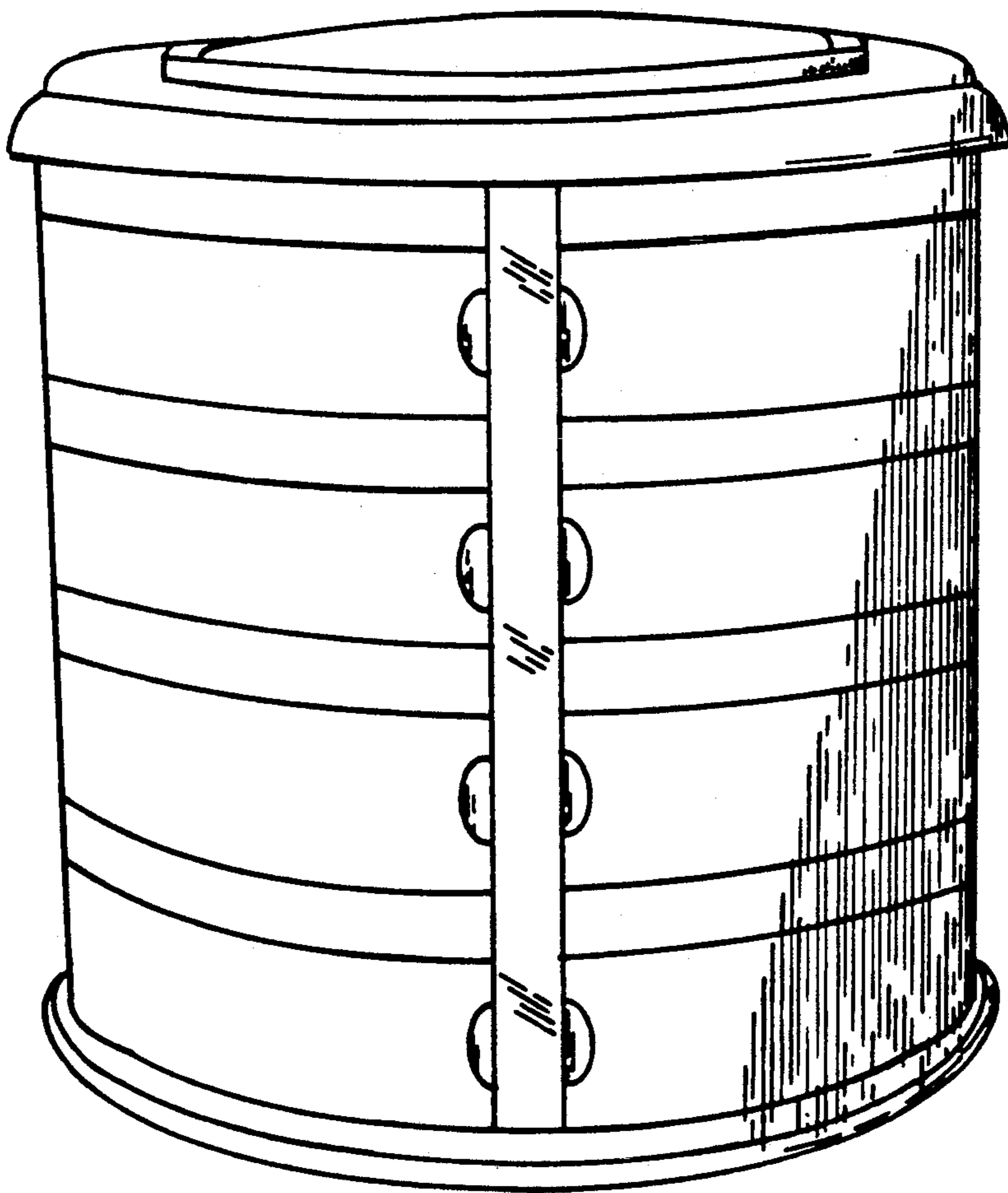

FIG. 8

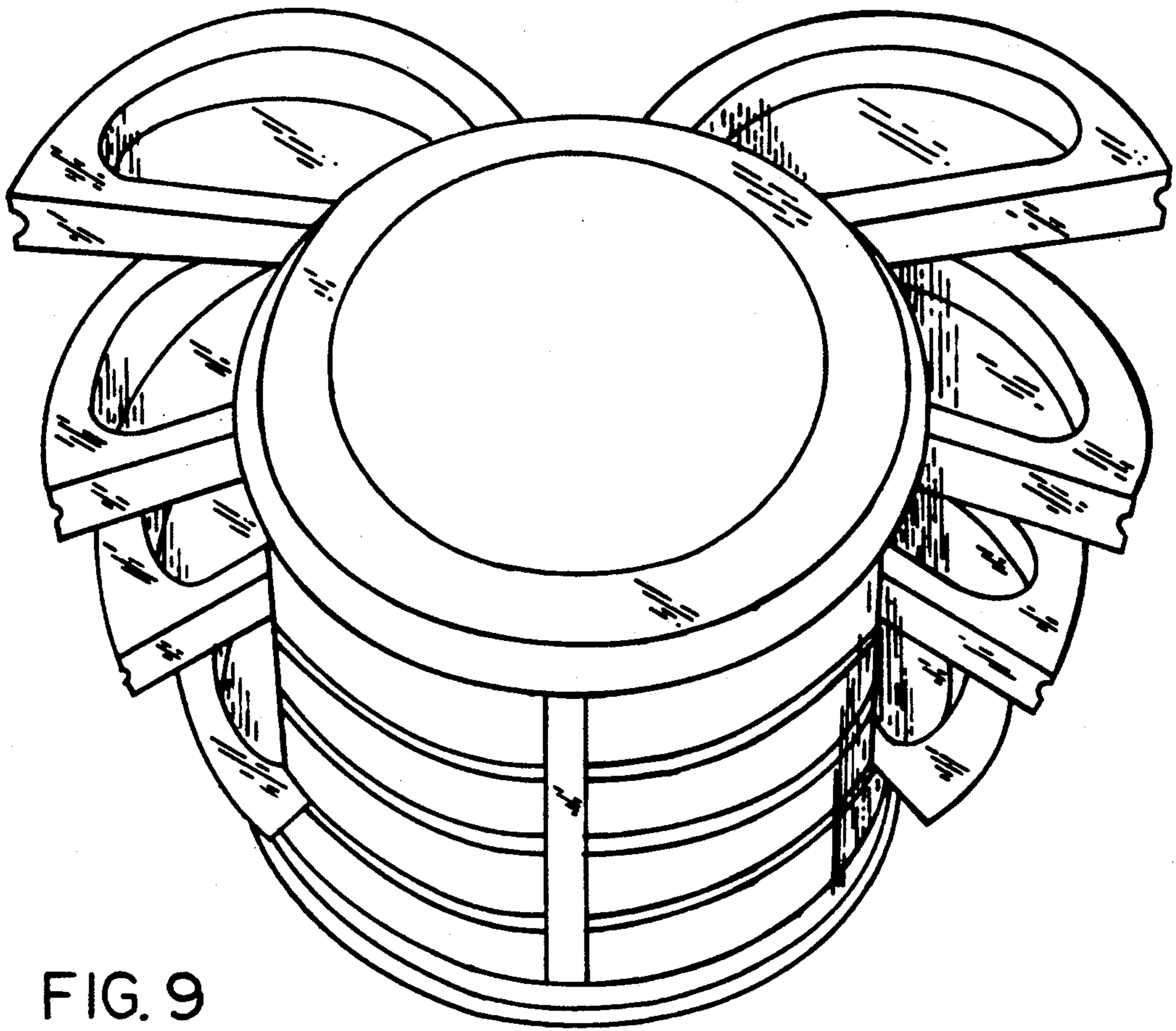

FIG. 9

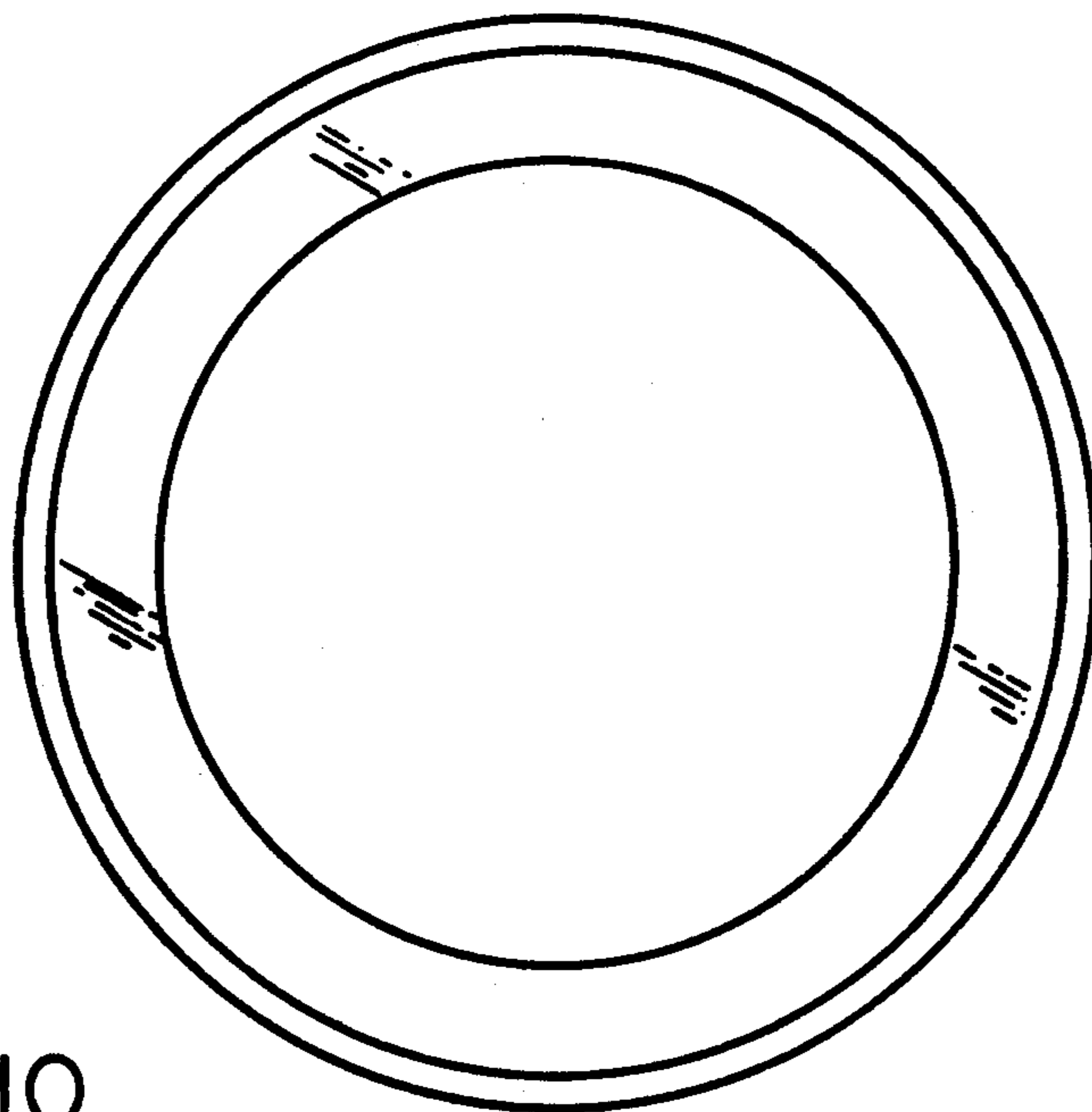

FIG. 10

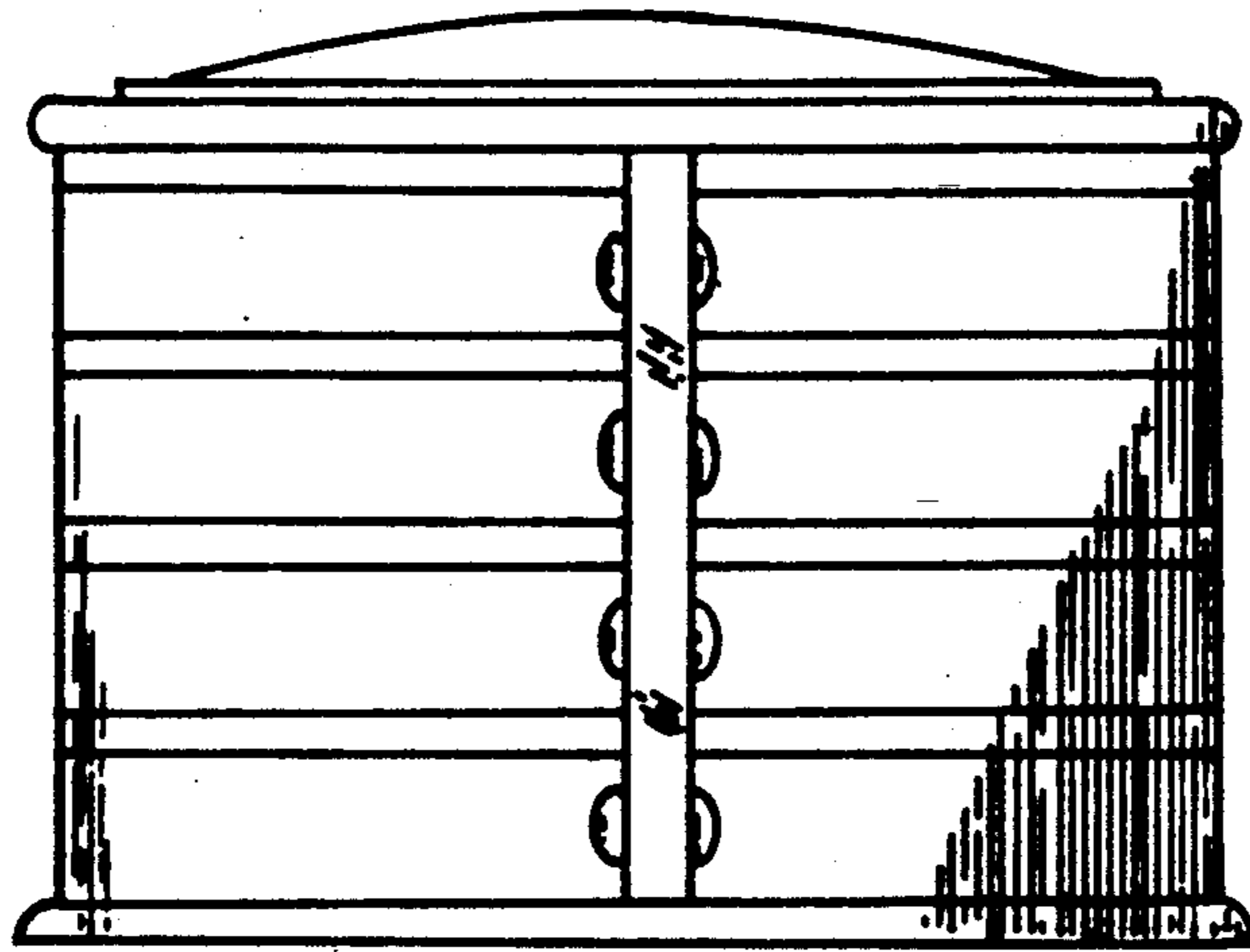

FIG. 11

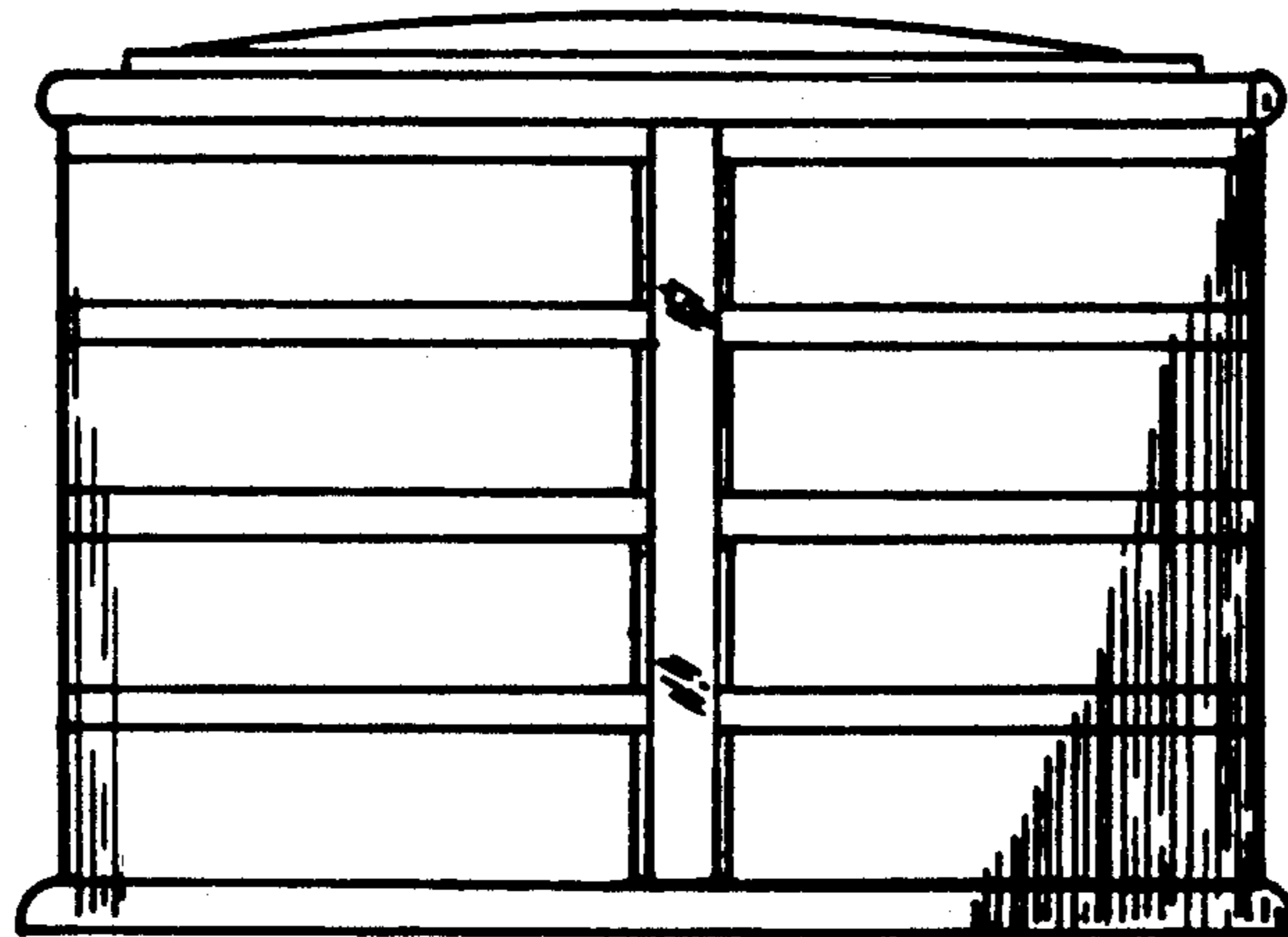

FIG. 12

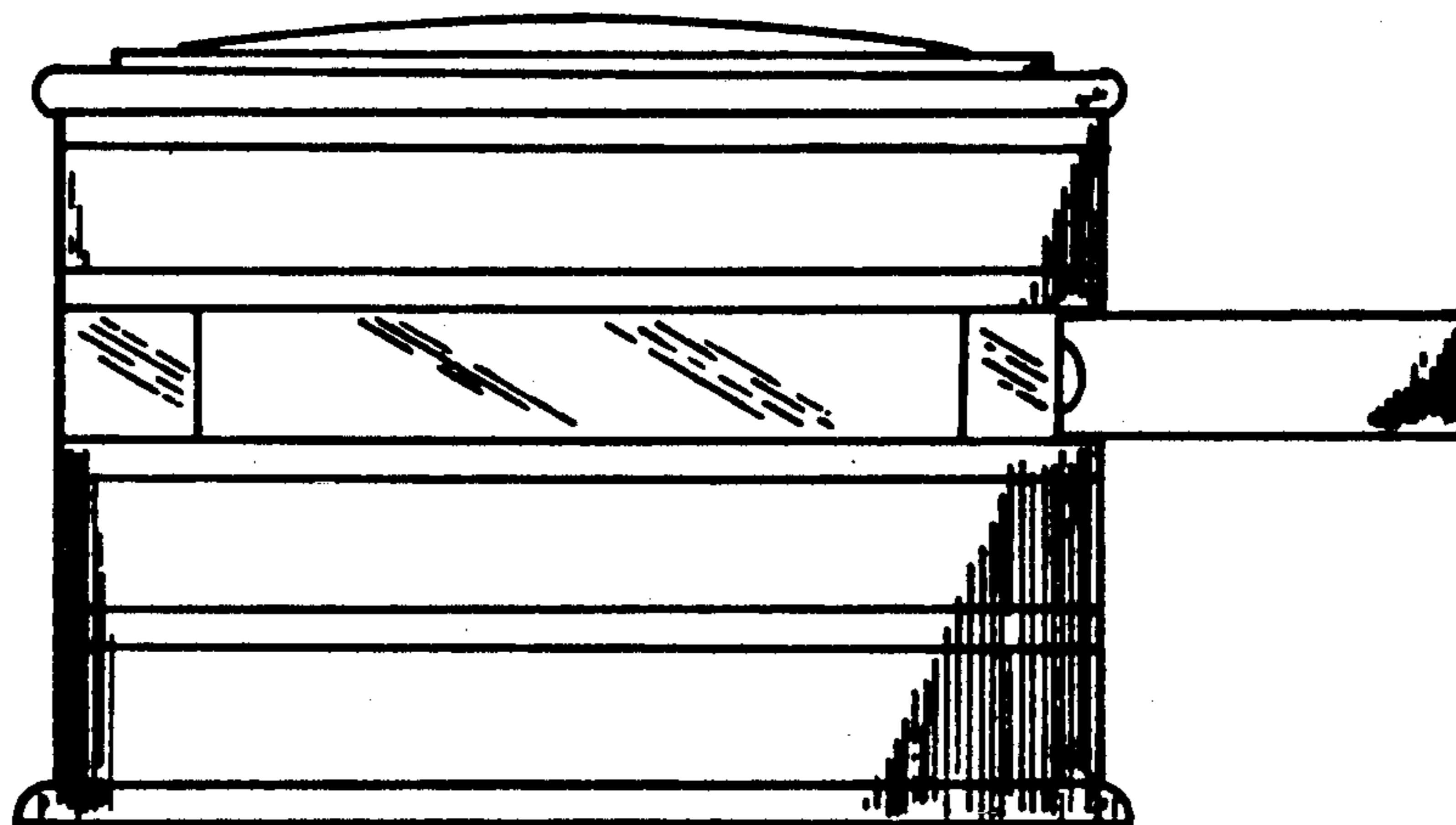

FIG. 13

UNITED STATES PATENT AND TRADEMARK OFFICE
CERTIFICATE OF CORRECTION

PATENT NO. : Des. 328,817
DATED : August 25, 1992
INVENTOR(S) : Charles L. Holland

Page 1 of 8

It is certified that error appears in the above-identified patent and that said Letters Patent is hereby corrected as shown below:

The title page should be deleted to appear as per attached title page.

The sheets of drawings consisting of figures 1-13, should be deleted to be replaced with the attached sheets.

Signed and Sealed this
Twenty-eight Day of March, 1995

Attest:



BRUCE LEHMAN

Attesting Officer

Commissioner of Patents and Trademarks

United States Patent [19]
Holland

[11] Patent Number: **Des. 328,817**

[45] Date of Patent: **Aug. 25, 1992**

[54] **JEWELRY CHEST**

[76] Inventor: **Charles L. Holland, 8512A Yellow Springs Rd., Frederick, Md. 21701**

[**] Term: **14 Years**

[21] Appl. No.: **327,141**

[22] Filed: **Mar. 22, 1989**

[52] U.S. Cl. **D3/75; D3/74; D3/66**

[58] Field of Search **D3/106, 99, 30.1, 66, D3/75, 74; D6/436, 444, 445, 455; D11/80; 206/827, 45; 312/324, 204, 201, 270, 326; 108/94, 139, 103, 111; D9/341**

[56] **References Cited**

U.S. PATENT DOCUMENTS

D. 259,153	5/1981	Valente	D3/66
D. 288,878	3/1987	Munson	D6/455
D. 306,238	2/1990	Pham-Phu	D6/444 X
837,176	11/1906	Beasley	312/324
1,831,401	11/1931	Weidlich et al.	312/324
2,533,102	12/1950	Gifford	312/324 X
2,775,498	12/1956	Gettel	312/201
3,087,770	4/1963	Gettel	312/270
3,202,470	8/1965	Lage	312/324
3,392,868	7/1968	Pfrommer	312/201 X
4,239,308	12/1980	Bradley	312/201

Primary Examiner—A. Hugo Word

Assistant Examiner—M. N. Pandozzi
Attorney, Agent, or Firm—Eugene F. Osborne, Sr.

[57] **CLAIM**

The ornamental design for a jewelry chest, as shown and described.

DESCRIPTION

FIG. 1 is a top front perspective view of a jewelry chest showing my new design in closed position;
 FIG. 2 is a rear perspective view thereof;
 FIG. 3 is a top, front perspective view thereof in open position;
 FIG. 4 is a top plan view thereof in closed position;
 FIG. 5 is a front elevational view thereof;
 FIG. 6 is a rear elevational view thereof;
 FIG. 7 is a right side elevational view, the left side being a mirror image thereof;
 FIG. 8 is a front elevational view of a jewelry chest showing a second embodiment of my new design;
 FIG. 9 is a top front perspective view thereof in open position;
 FIG. 10 is a top plan view thereof, in closed position;
 FIG. 11 is a front elevational view thereof;
 FIG. 12 is a rear elevational view thereof; and,
 FIG. 13 is a right side elevational view in open position the left side being a mirror image thereof.
 The bottom of both embodiments are plain and unornamented.

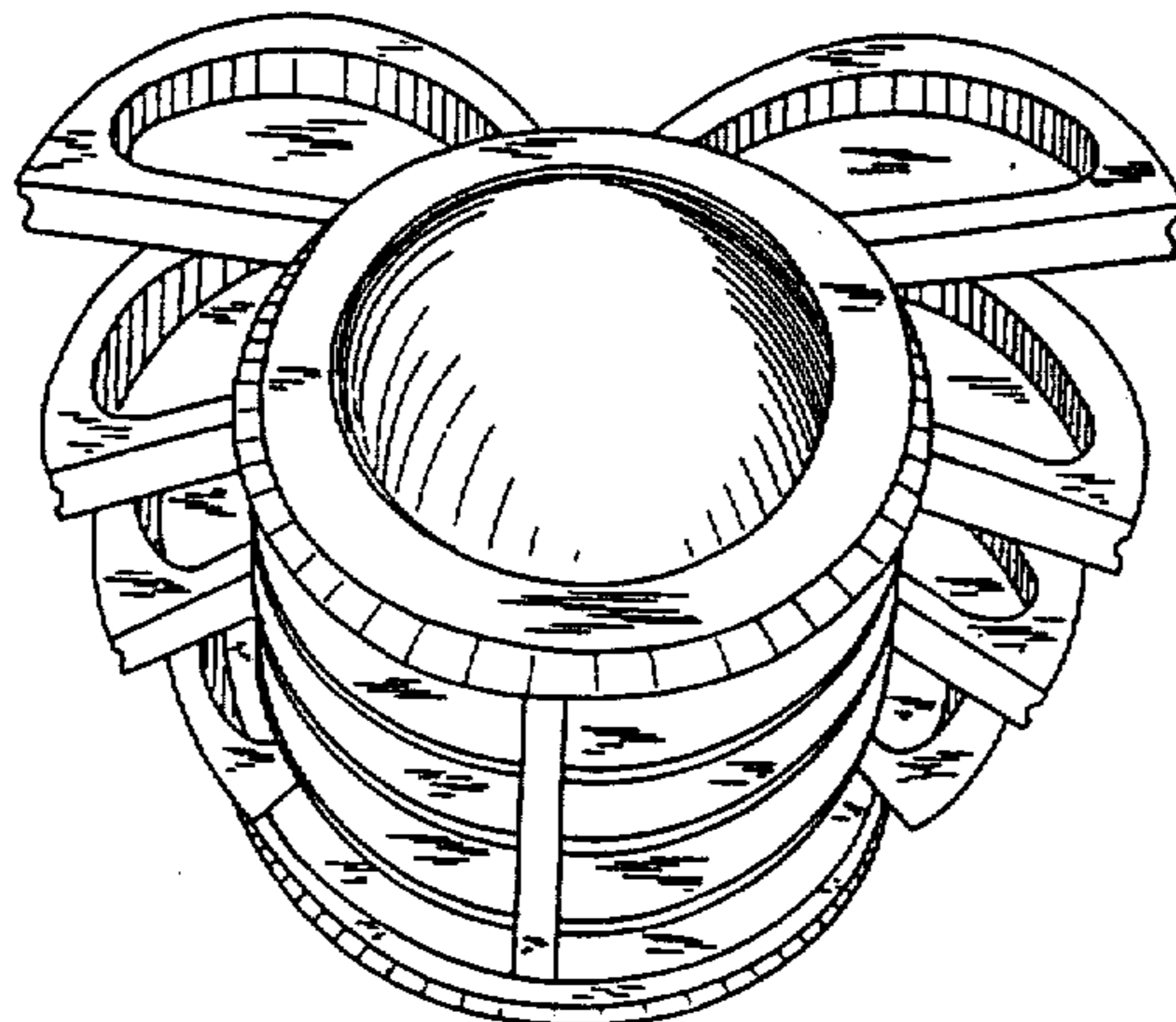
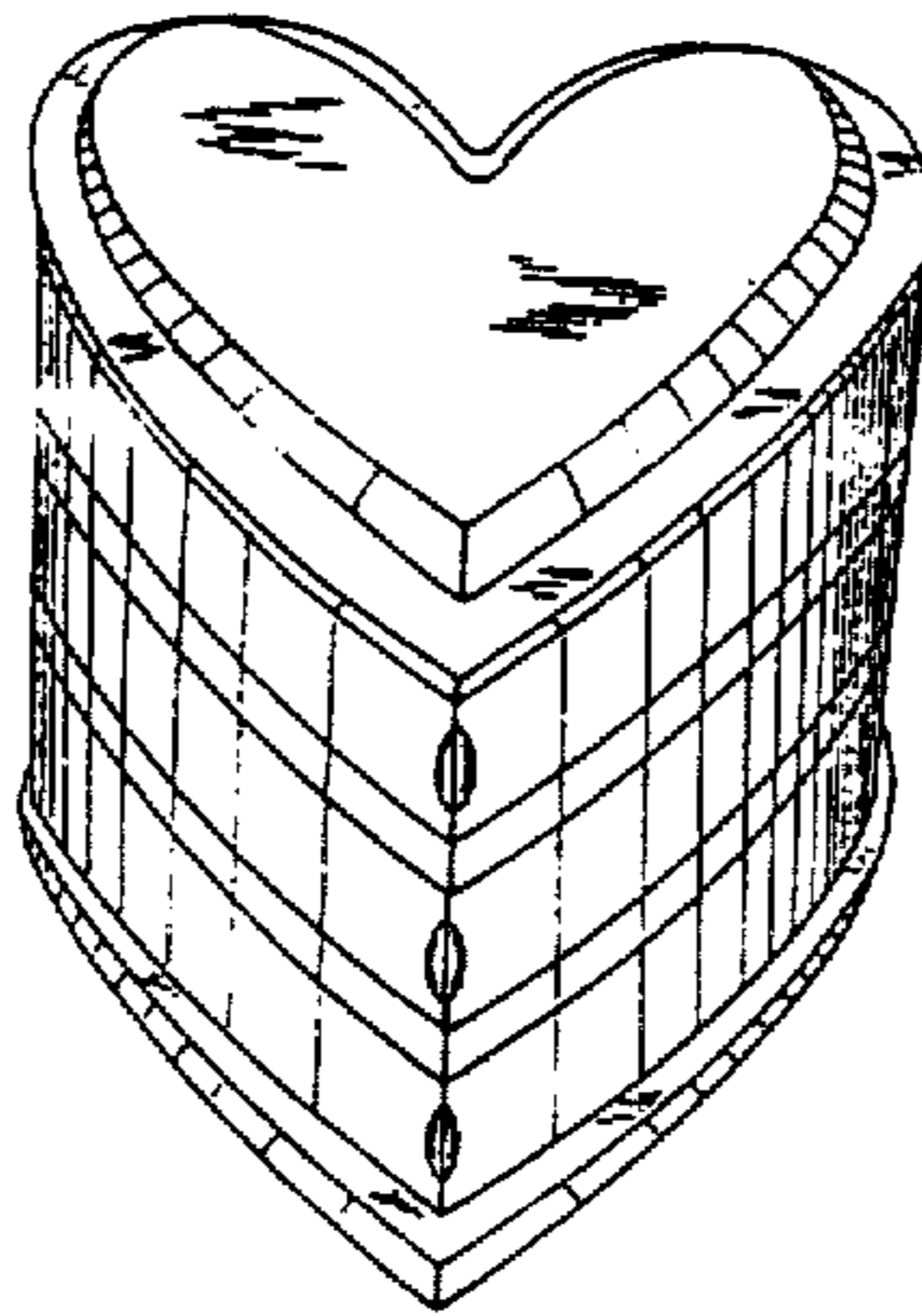

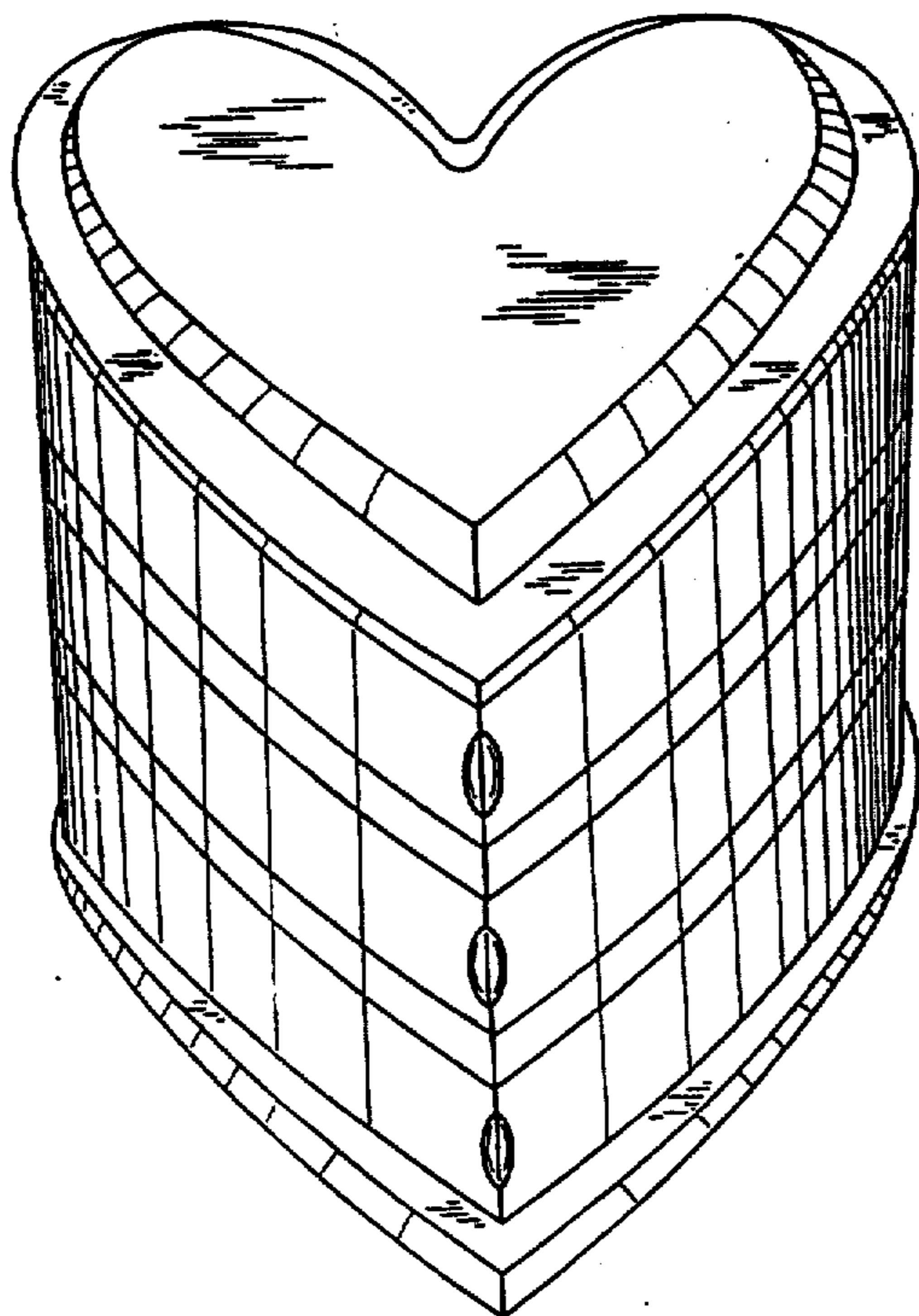

FIG. 1

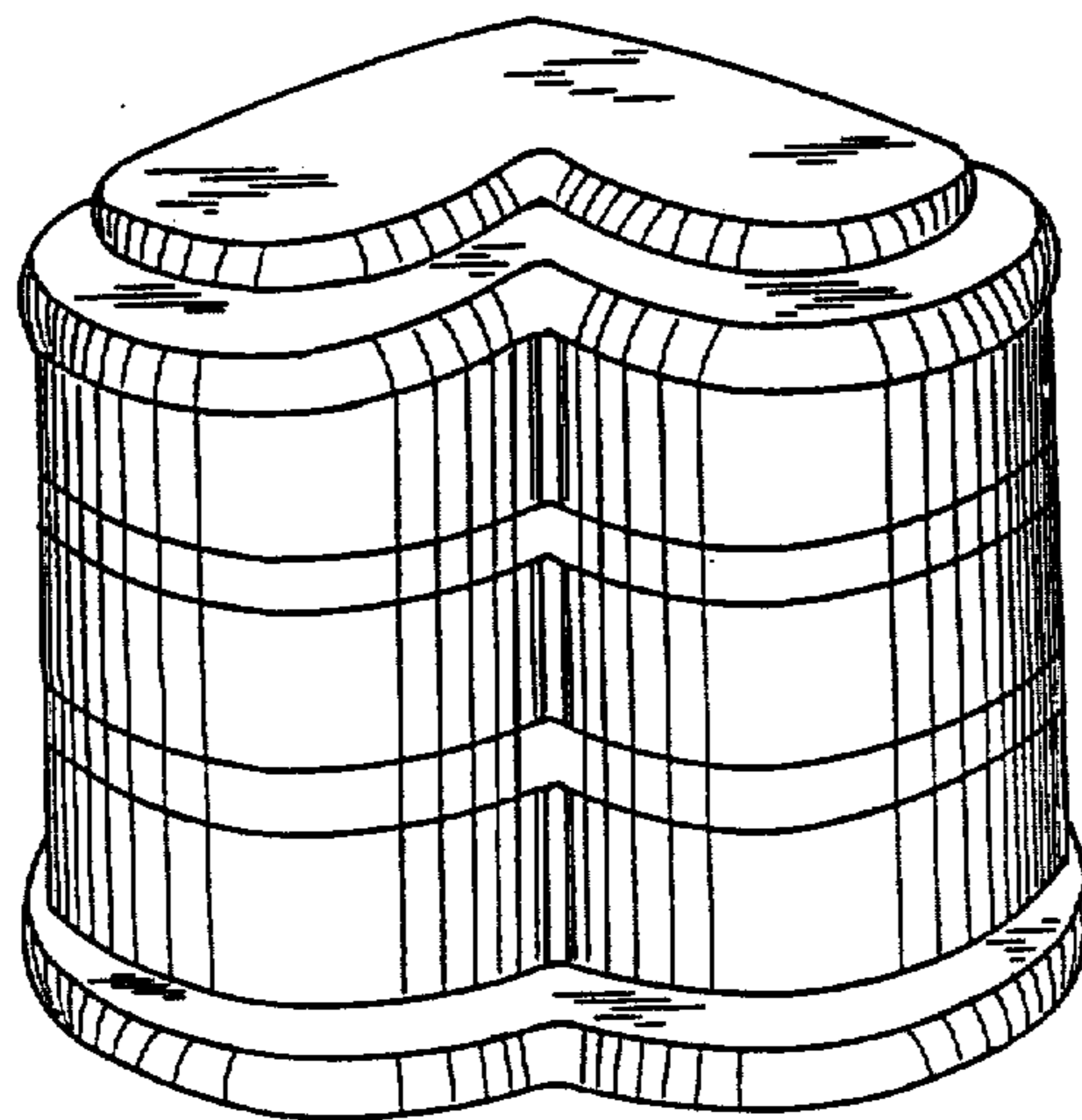

FIG. 2

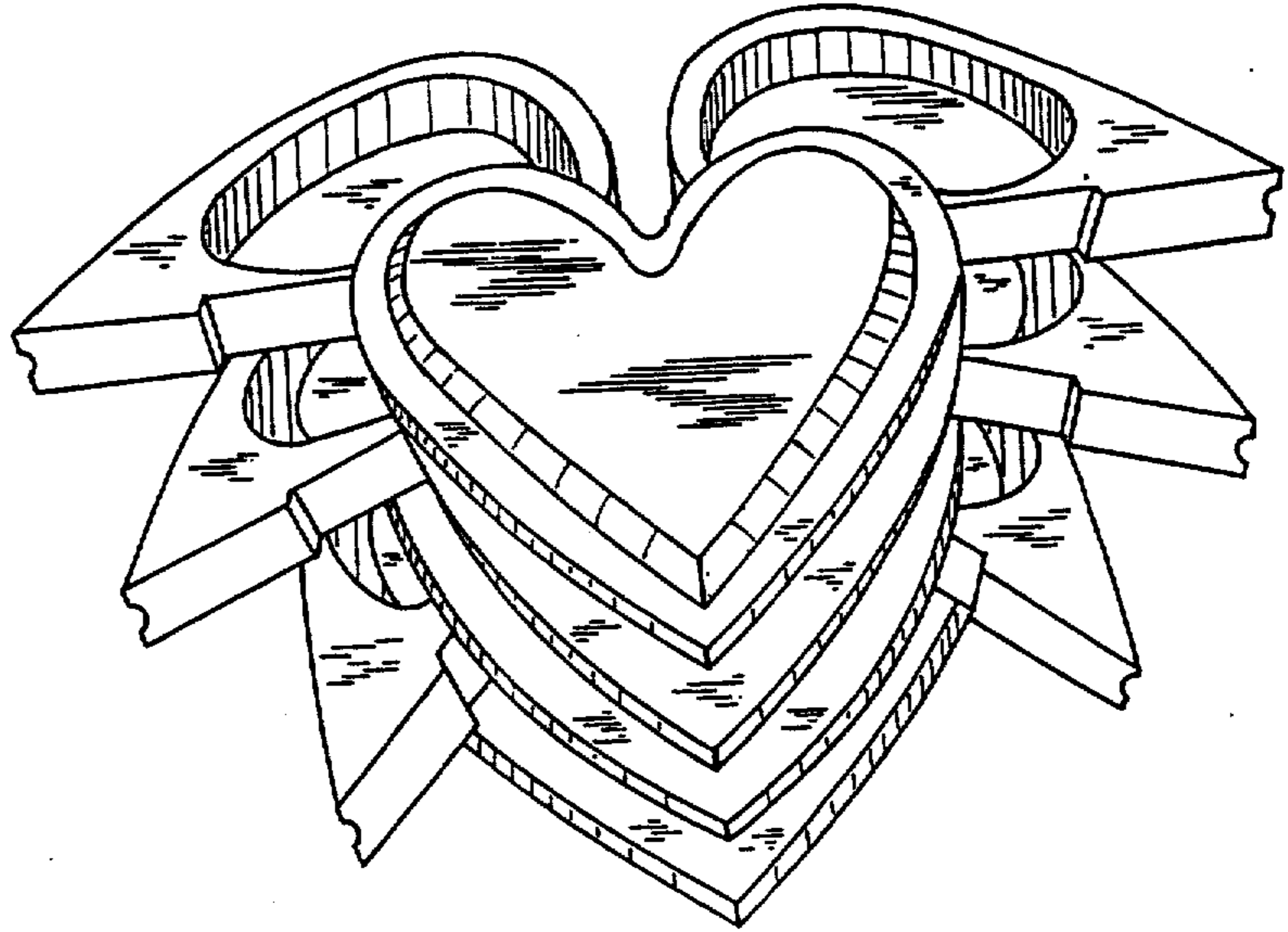

FIG. 3

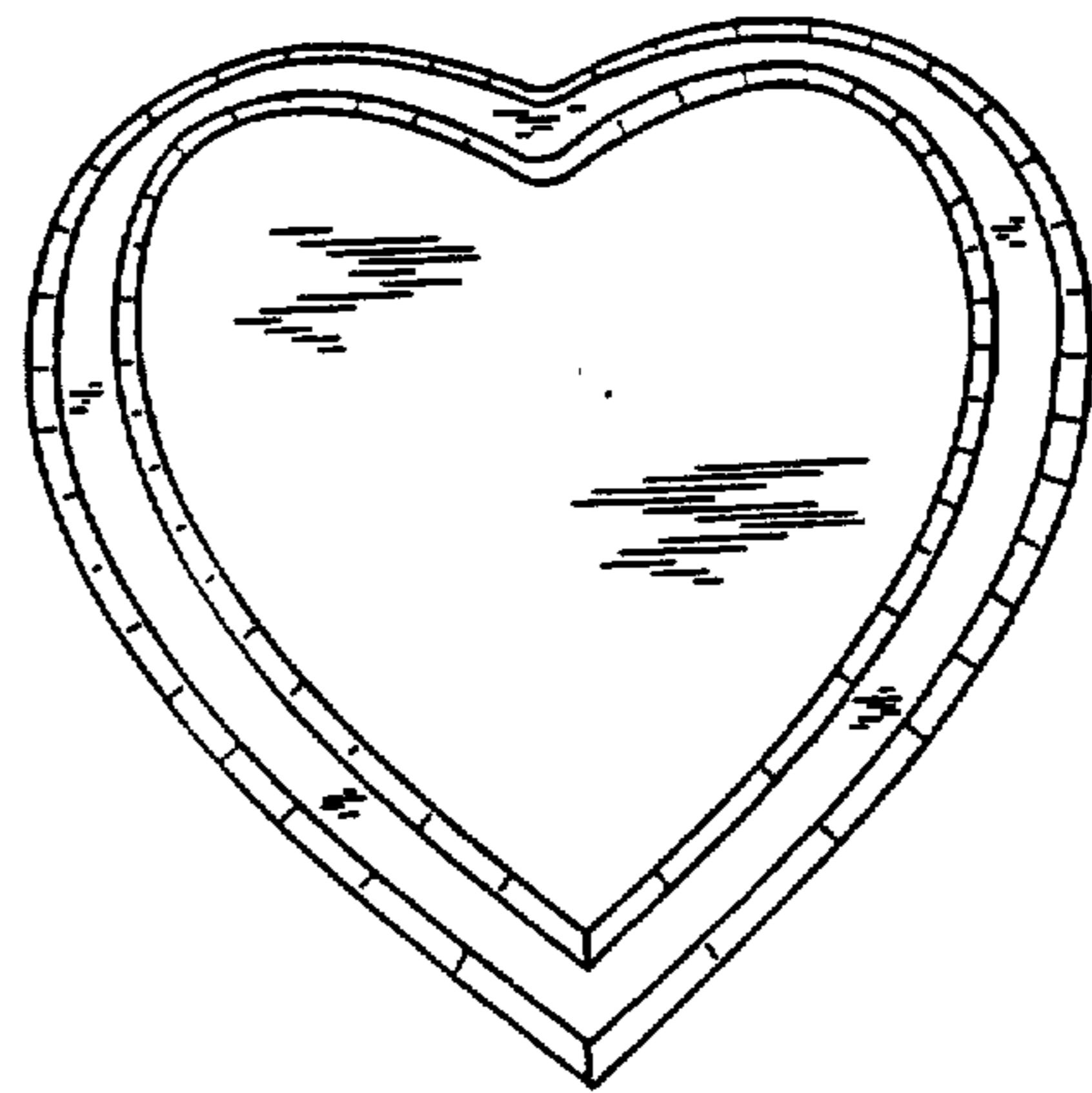

FIG. 4

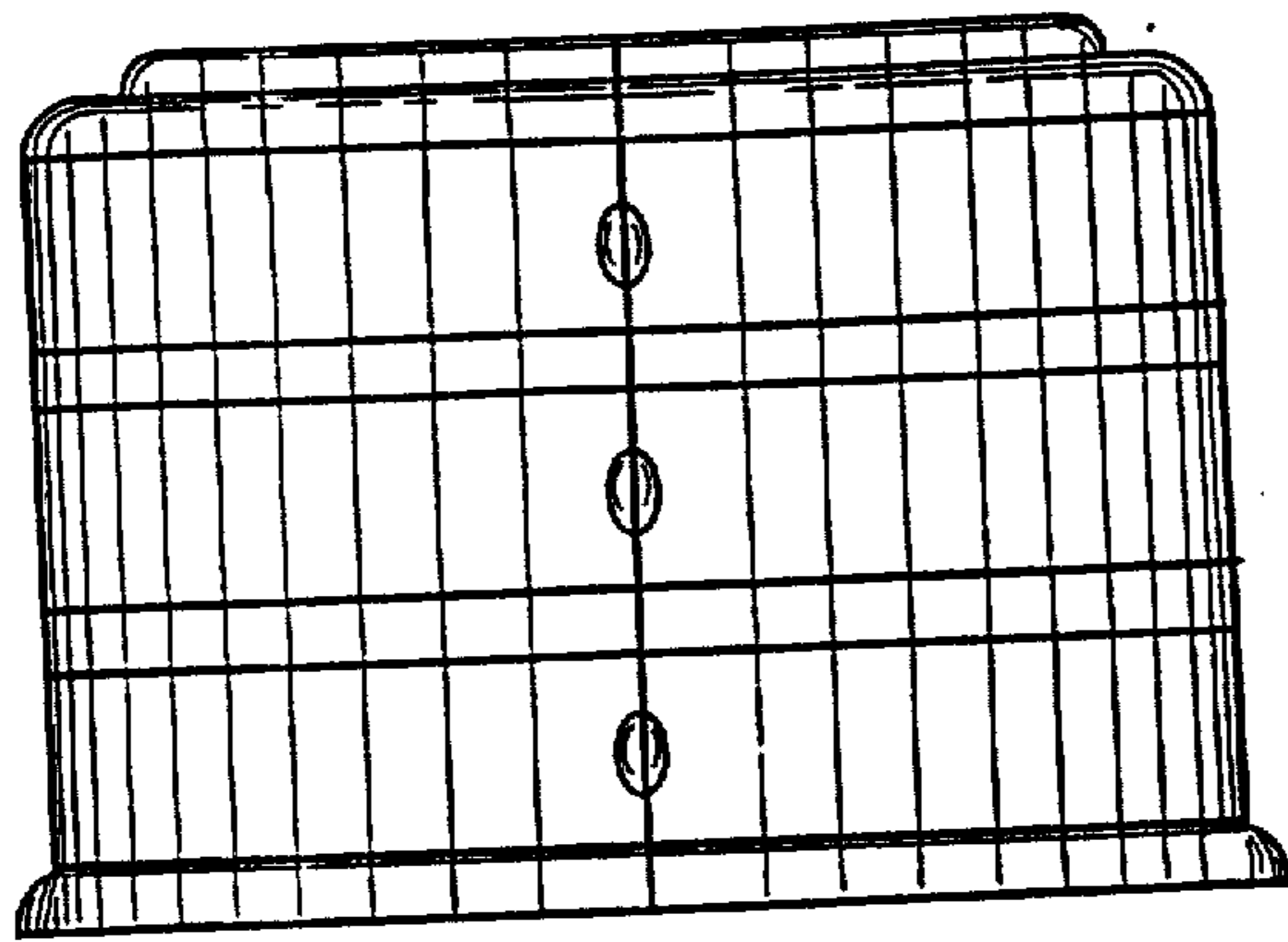

FIG. 5

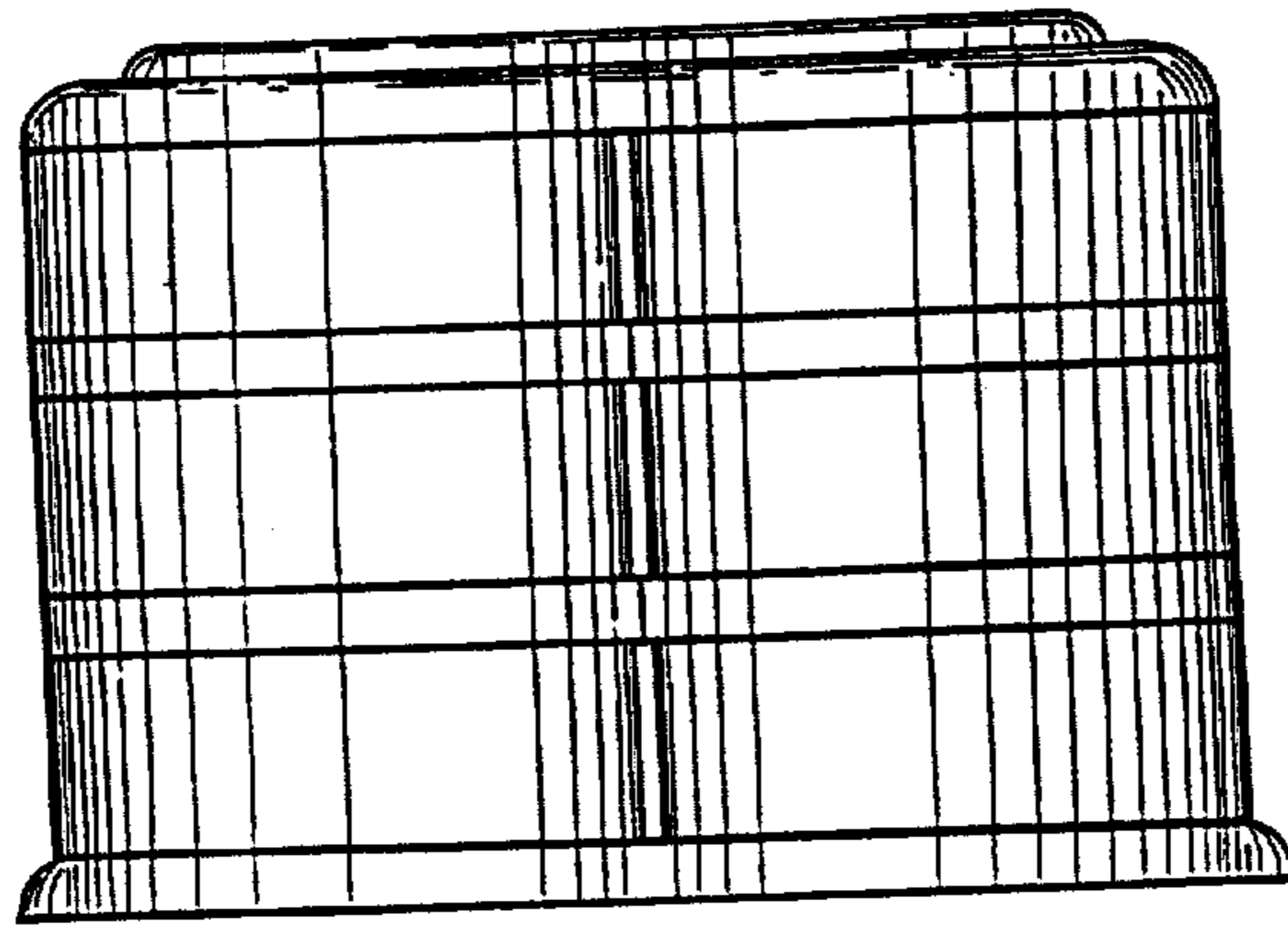

FIG. 6

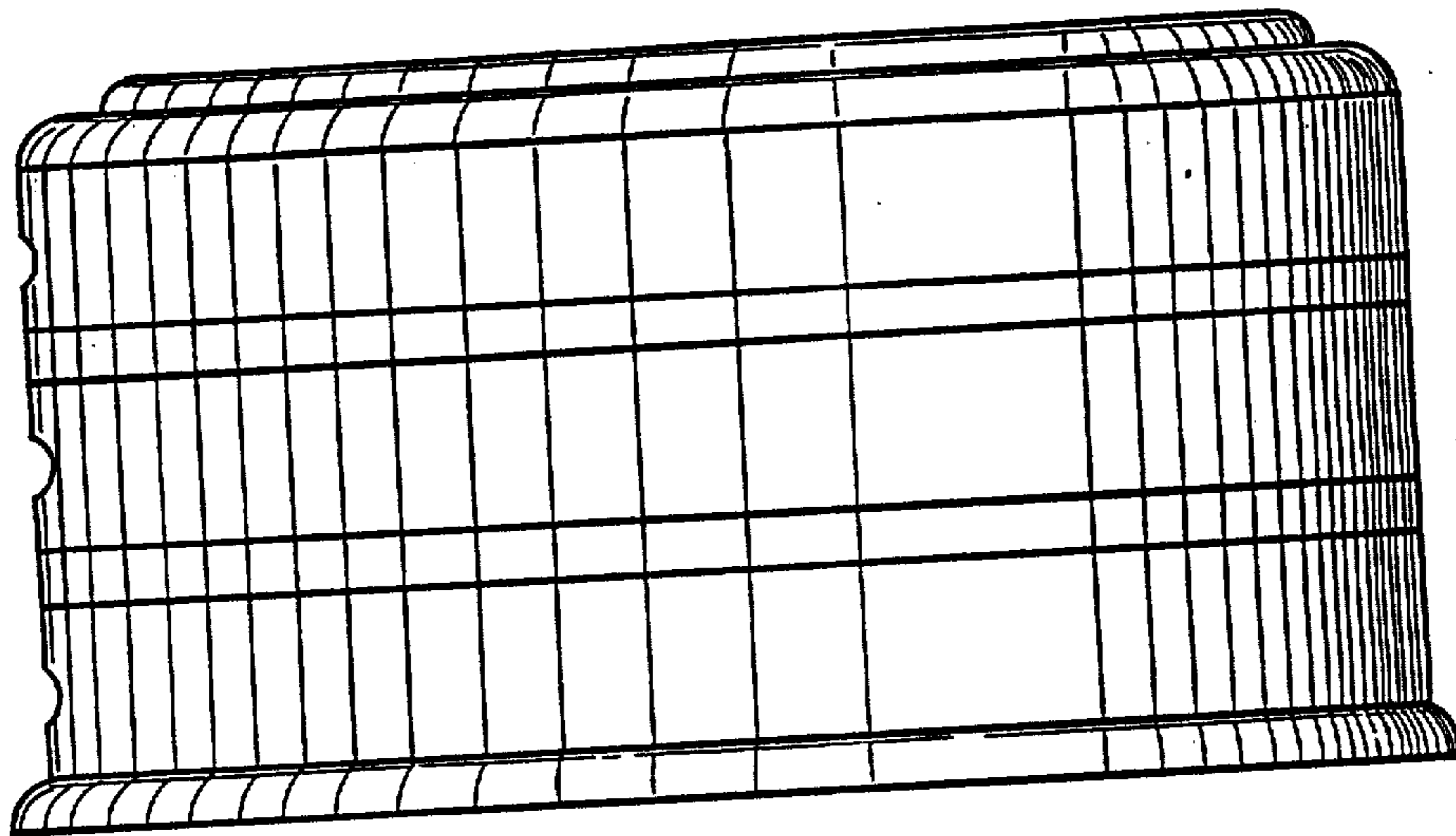

FIG. 7

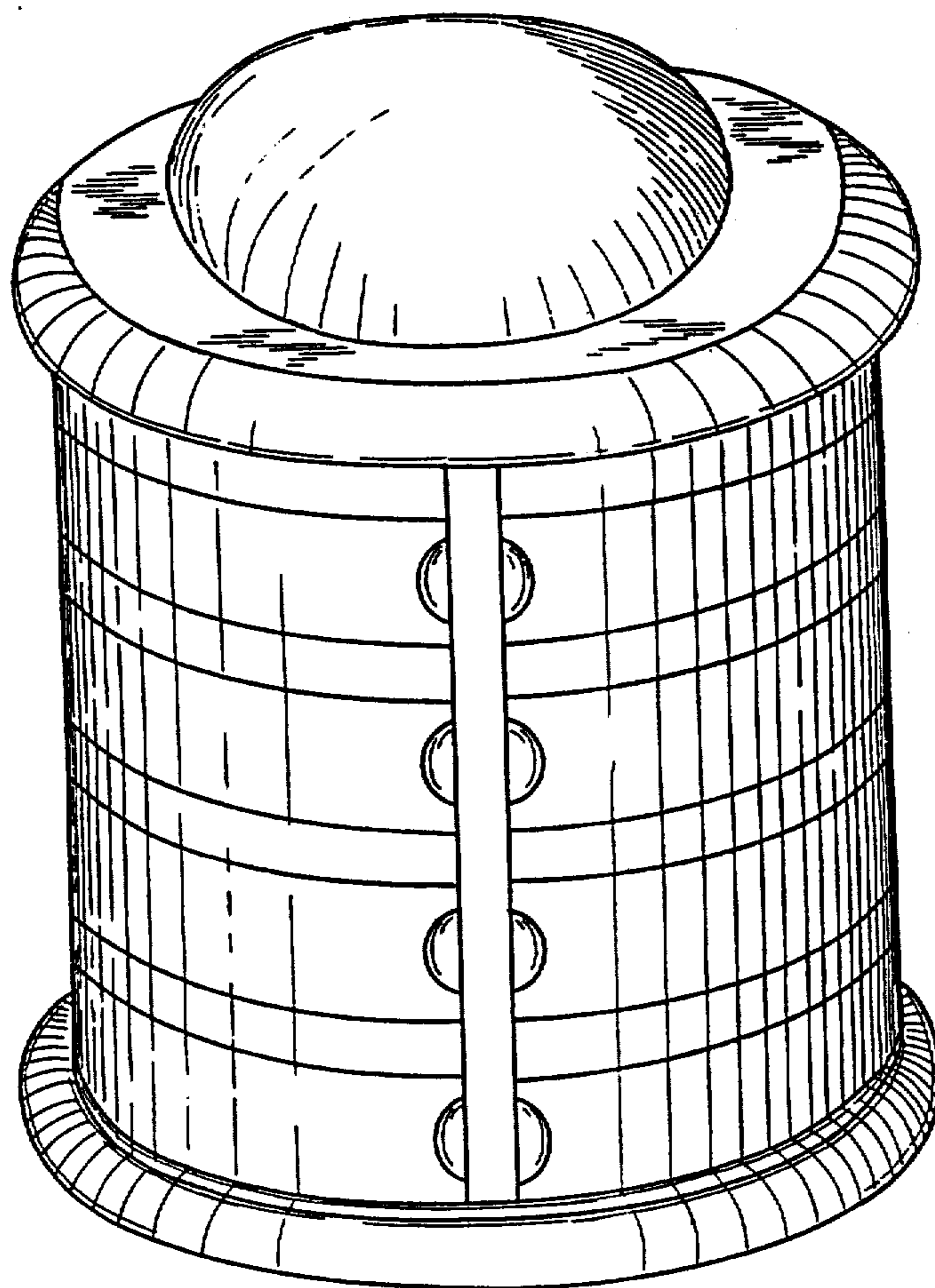

FIG. 8

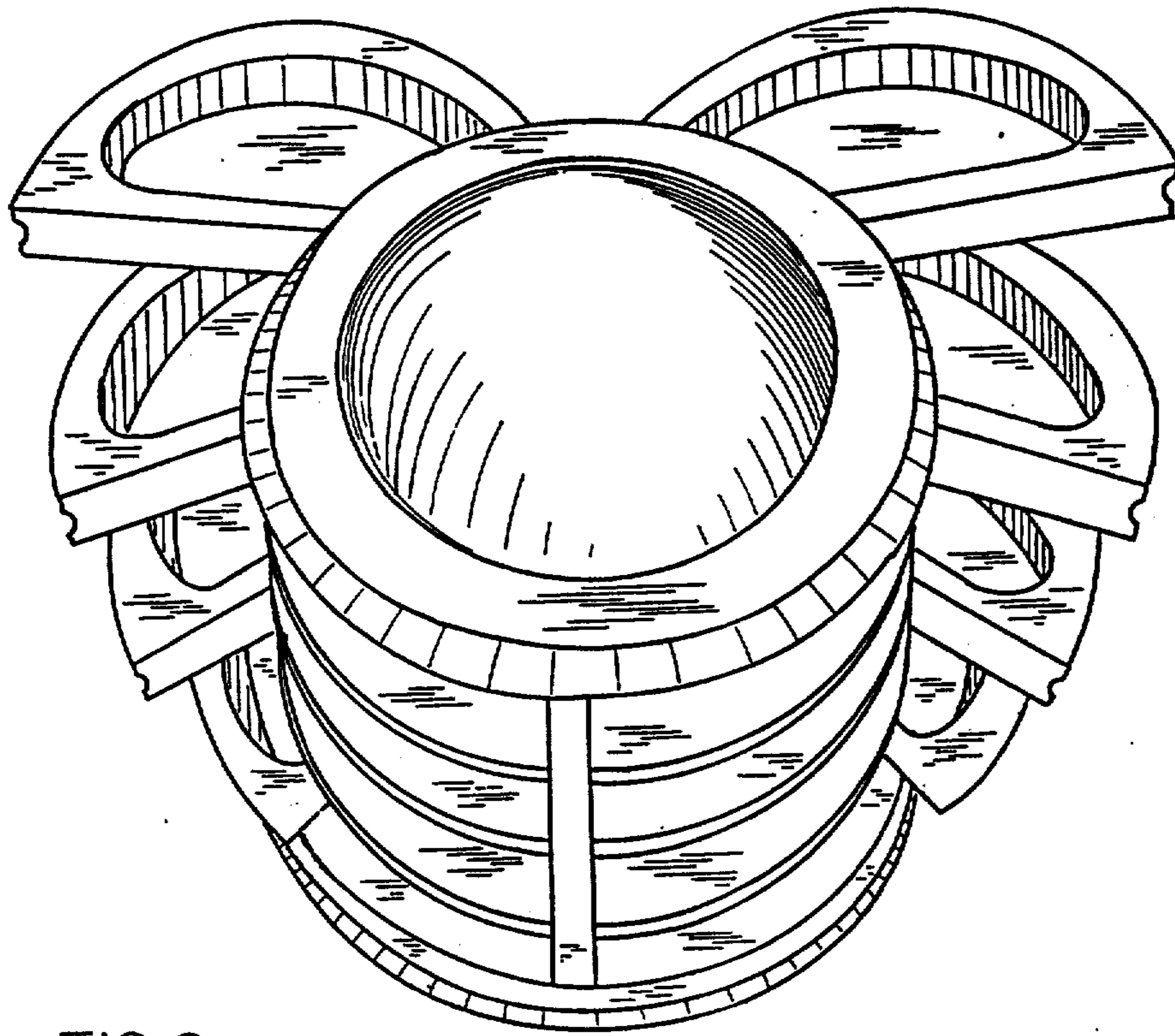

FIG. 9

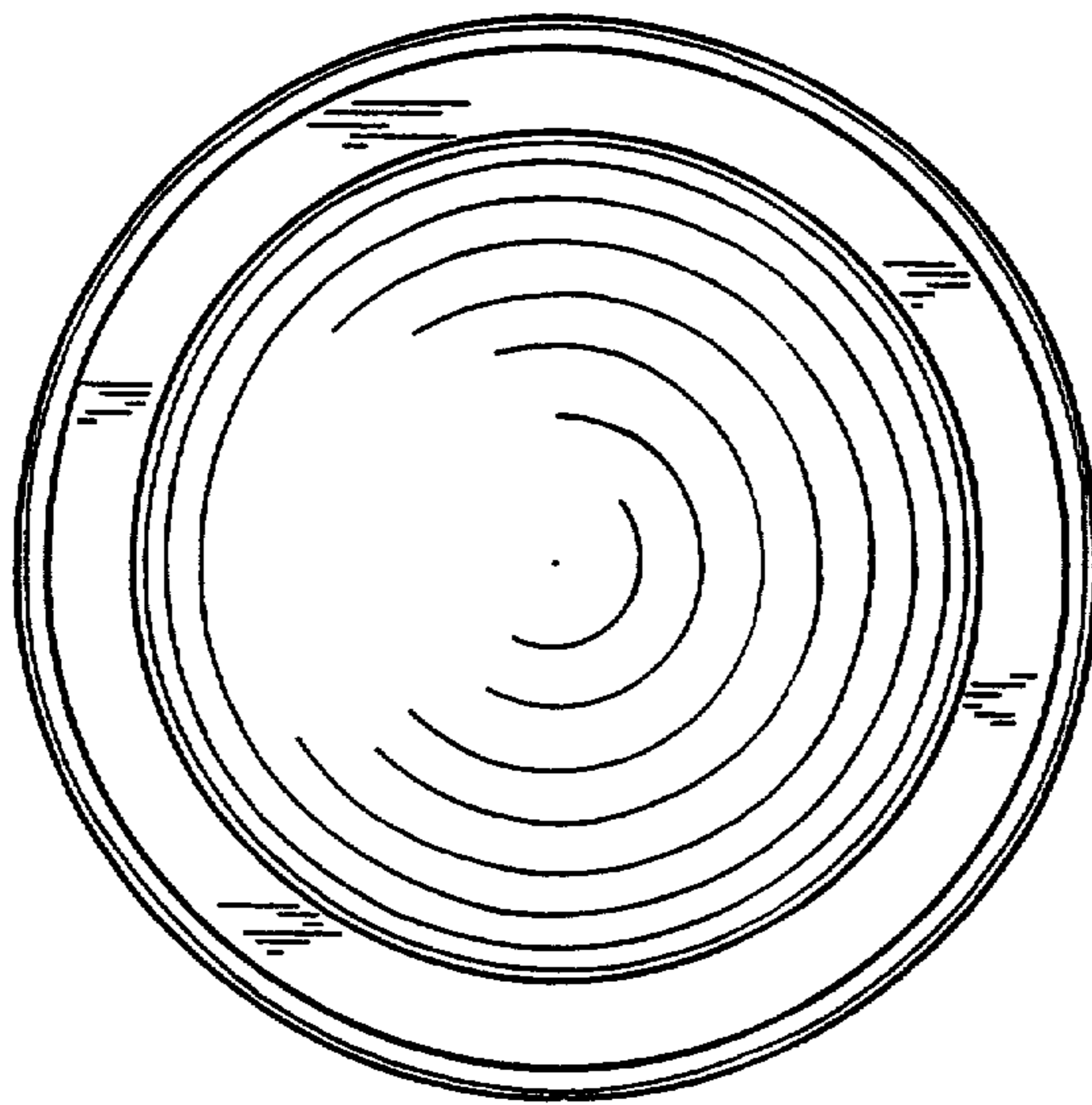

FIG. 10

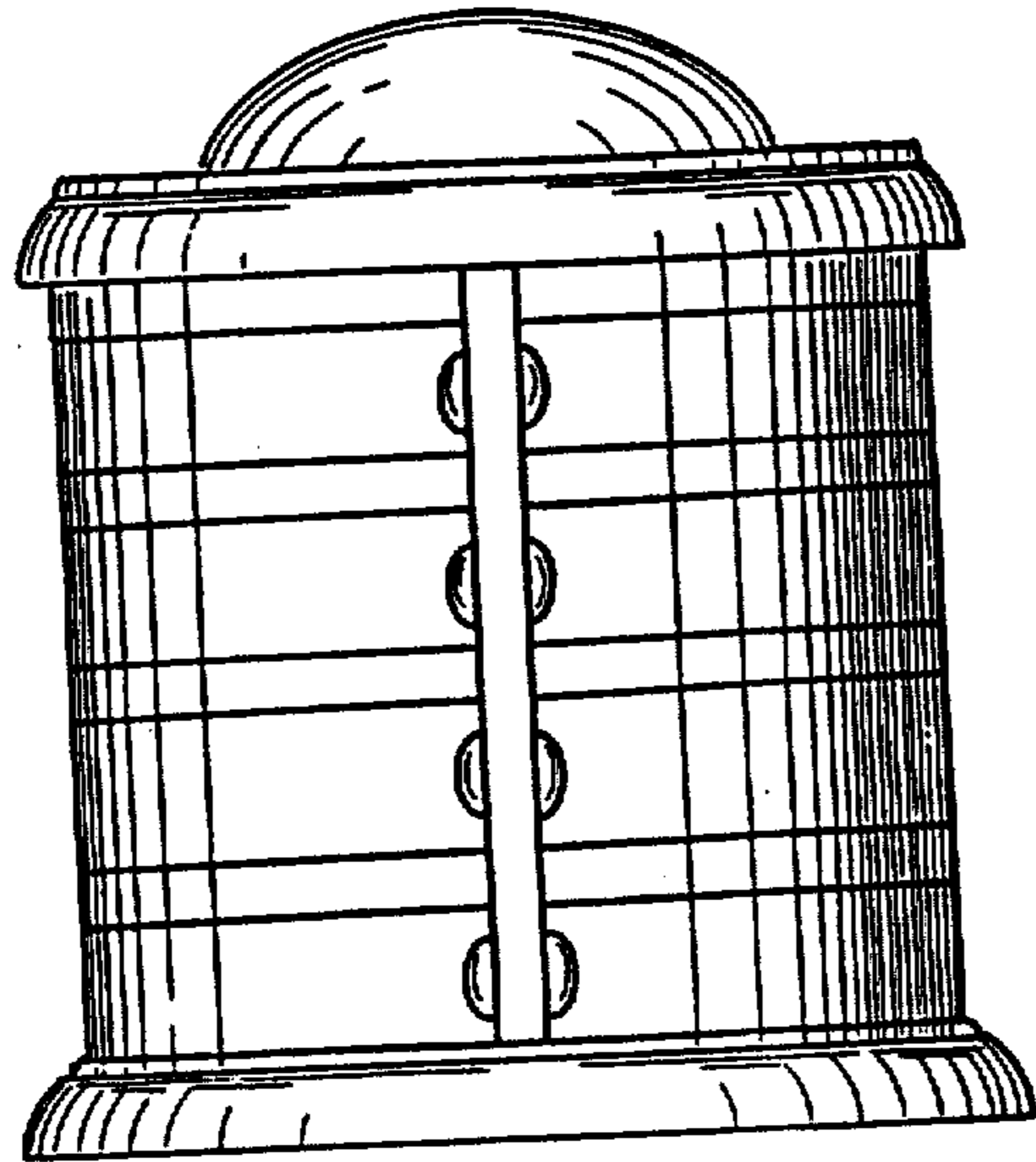

FIG. 11

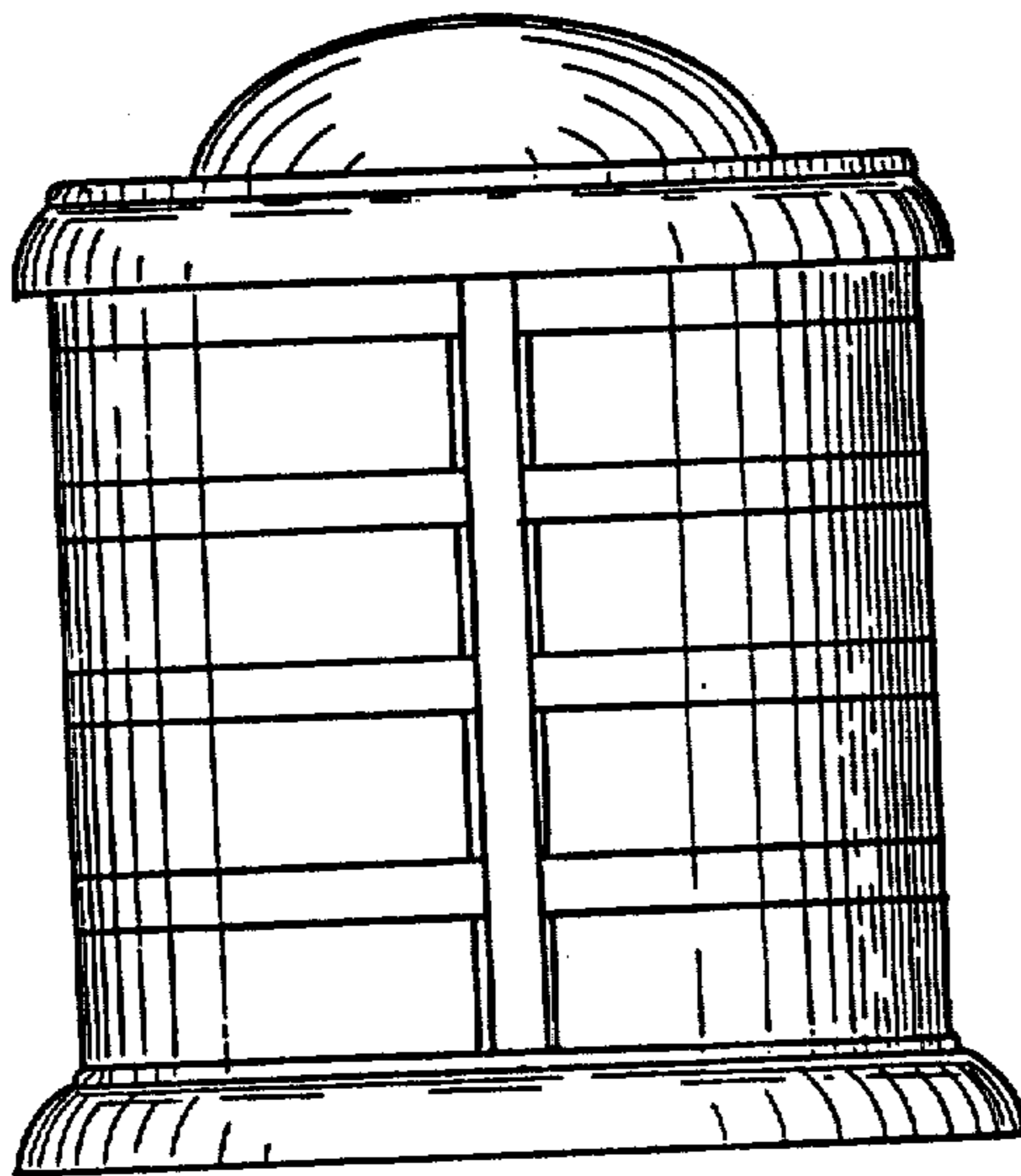

FIG. 12

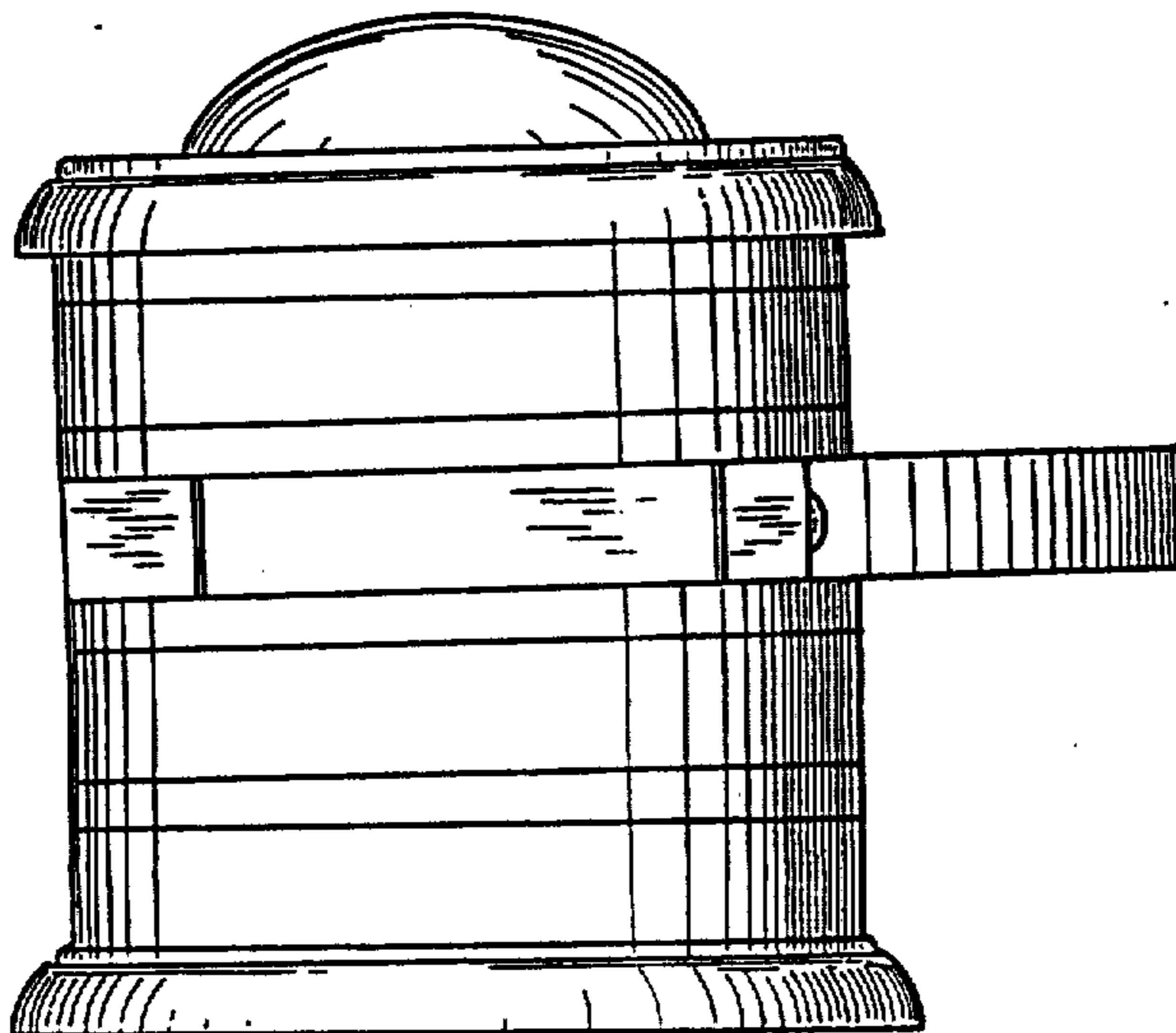

FIG. 13