



US00D328761S

United States Patent [19]

[11] Patent Number: **Des. 328,761**

Evenson

[45] Date of Patent: **** Aug. 18, 1992**

[54] **LITERATURE ORGANIZER**

[75] Inventor: **Mel Evenson, San Pedro, Calif.**

[73] Assignee: **Eldon Industries, Inc., Inglewood, Calif.**

[**] Term: **14 Years**

[21] Appl. No.: **653,112**

[22] Filed: **Feb. 11, 1991**

[52] U.S. Cl. **D19/90; D6/407; D6/476; D19/86; D19/91**

[58] Field of Search **D6/407, 476, 467; D19/65, 75, 78, 86, 90, 91, 95, 99, 100; 206/215, 425; 211/10, 11, 35, 42, 45, 50, 55, 184**

[56] **References Cited**

U.S. PATENT DOCUMENTS

- D. 104,956 6/1937 Baker D6/476 X
- D. 231,137 4/1974 Juhlin D19/90
- D. 240,104 6/1976 Juhlin D6/476 X
- D. 258,511 3/1981 Ashton D19/90

- D. 299,360 1/1989 Klodt D19/75 X
- D. 299,478 1/1989 Klodt D19/75 X
- D. 314,215 1/1991 Hawes, Jr. et al. D19/90
- D. 323,190 1/1992 Evenson D19/90
- D. 323,854 2/1992 Evenson D19/86 X
- 2,197,789 4/1940 Dalton D6/476 X

Primary Examiner—Nelson C. Holtje
Assistant Examiner—Martha Thompson

[57] **CLAIM**

The ornamental design for a literature organizer, as shown and described.

DESCRIPTION

FIG. 1 is a front elevational view of a literature organizer showing my new design; FIG. 2 is a rear elevational view; FIG. 3 is a right side elevational view, the left side being a mirror image thereof; FIG. 4 is a top plan view; FIG. 5 is a bottom plan view; and, FIG. 6 is a top, right front perspective view thereof drawn to a reduced scale.

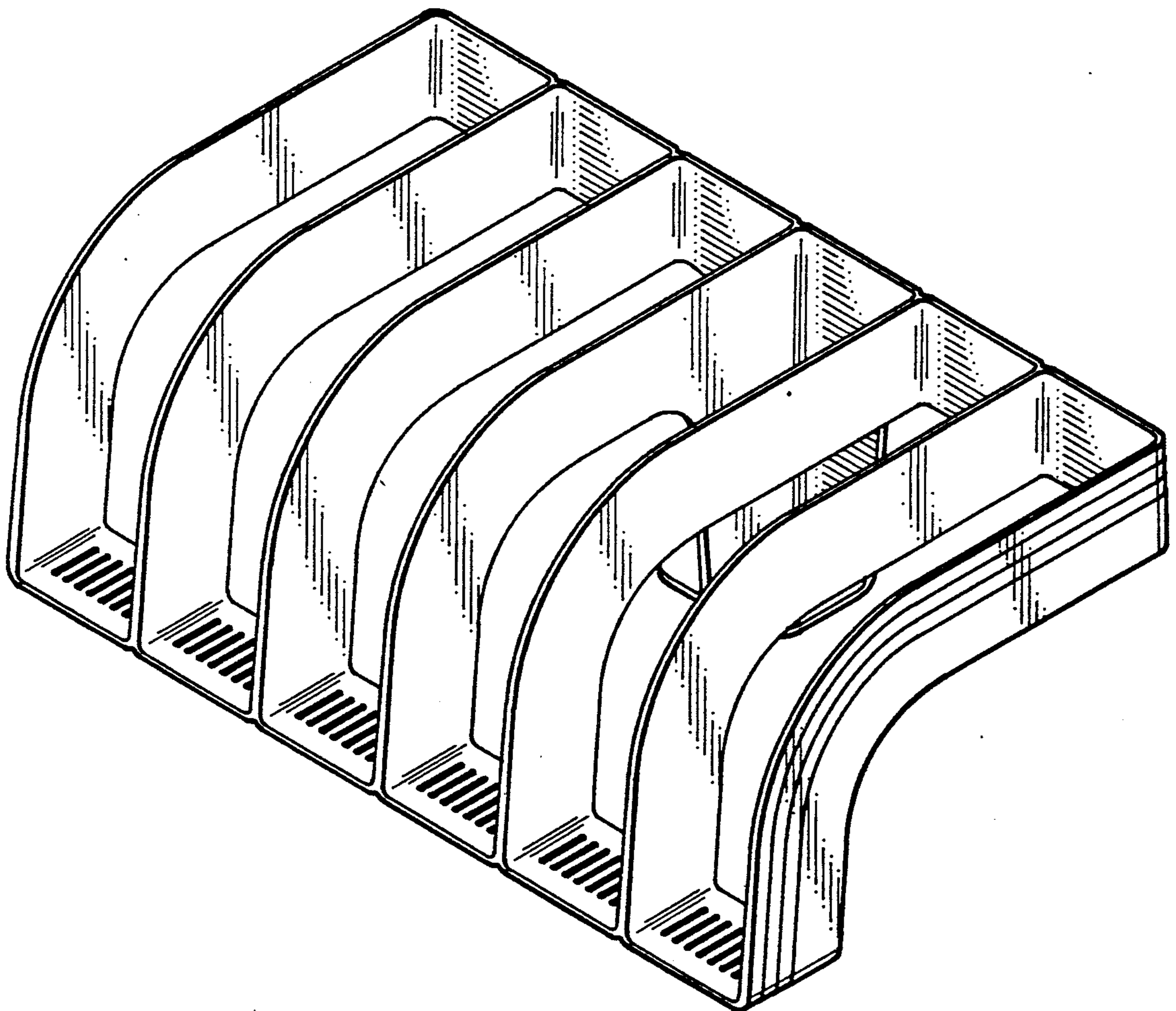

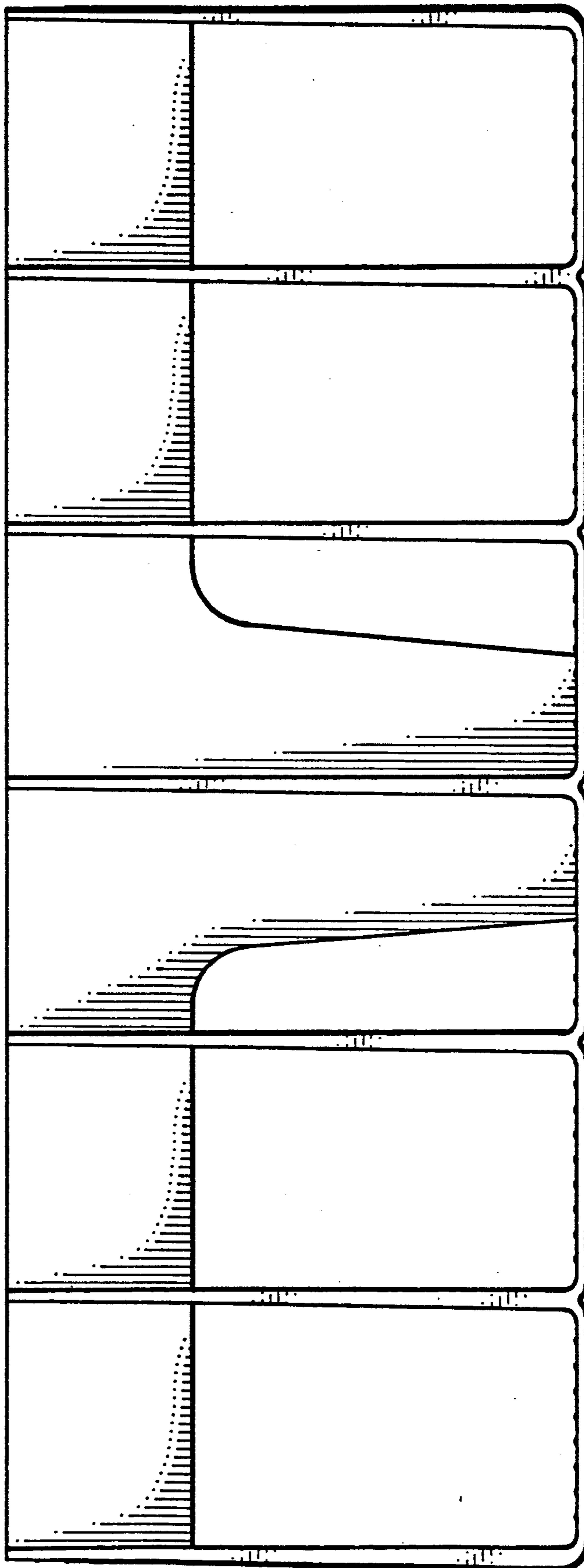

FIG. 1

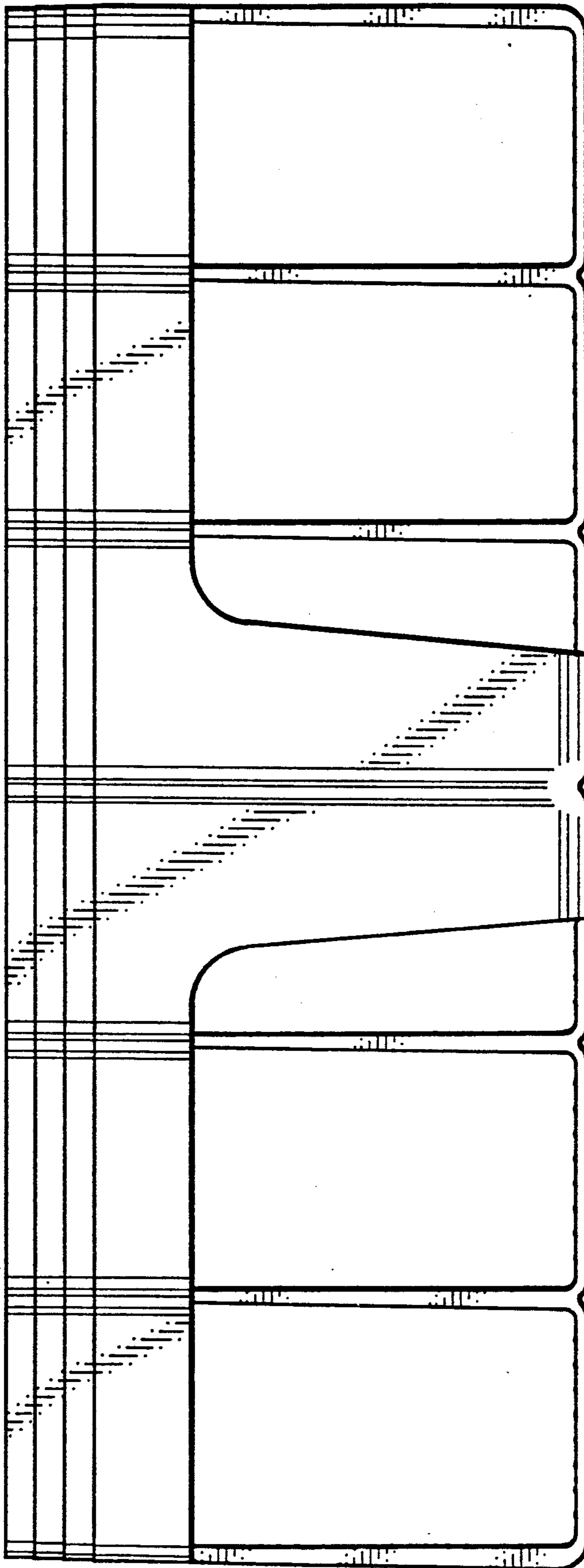

FIG. 2

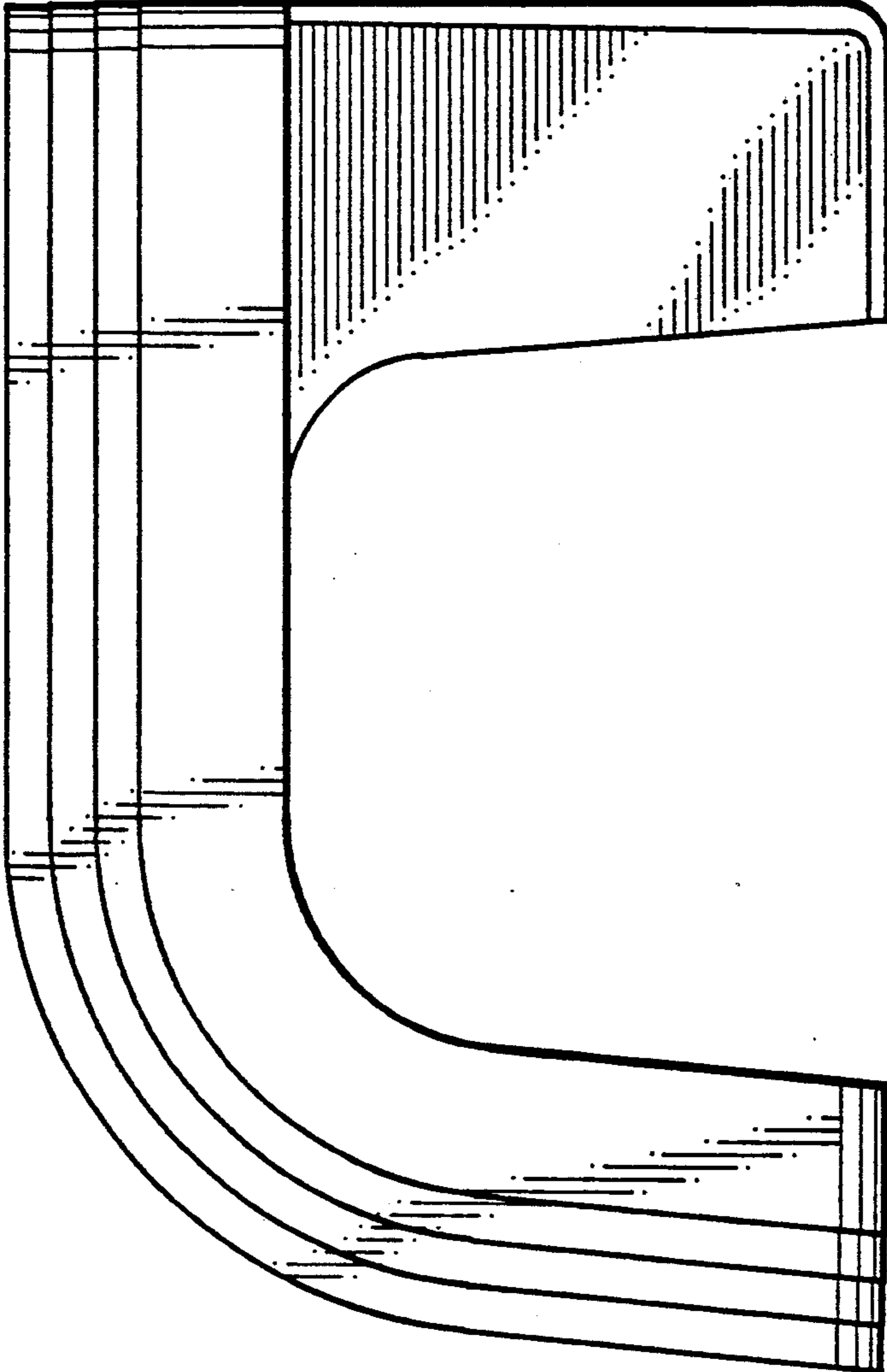

FIG. 3

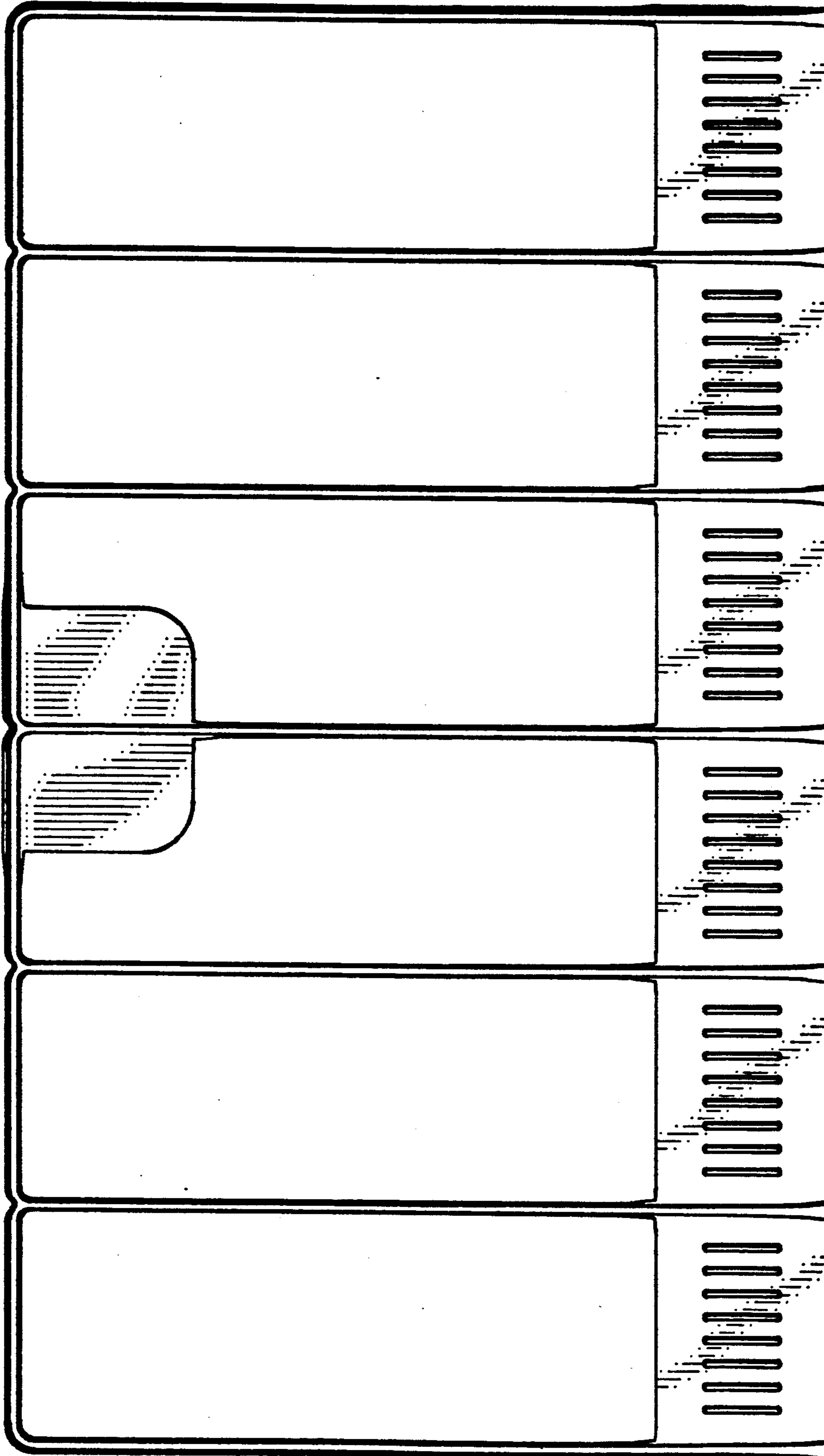

FIG. 4

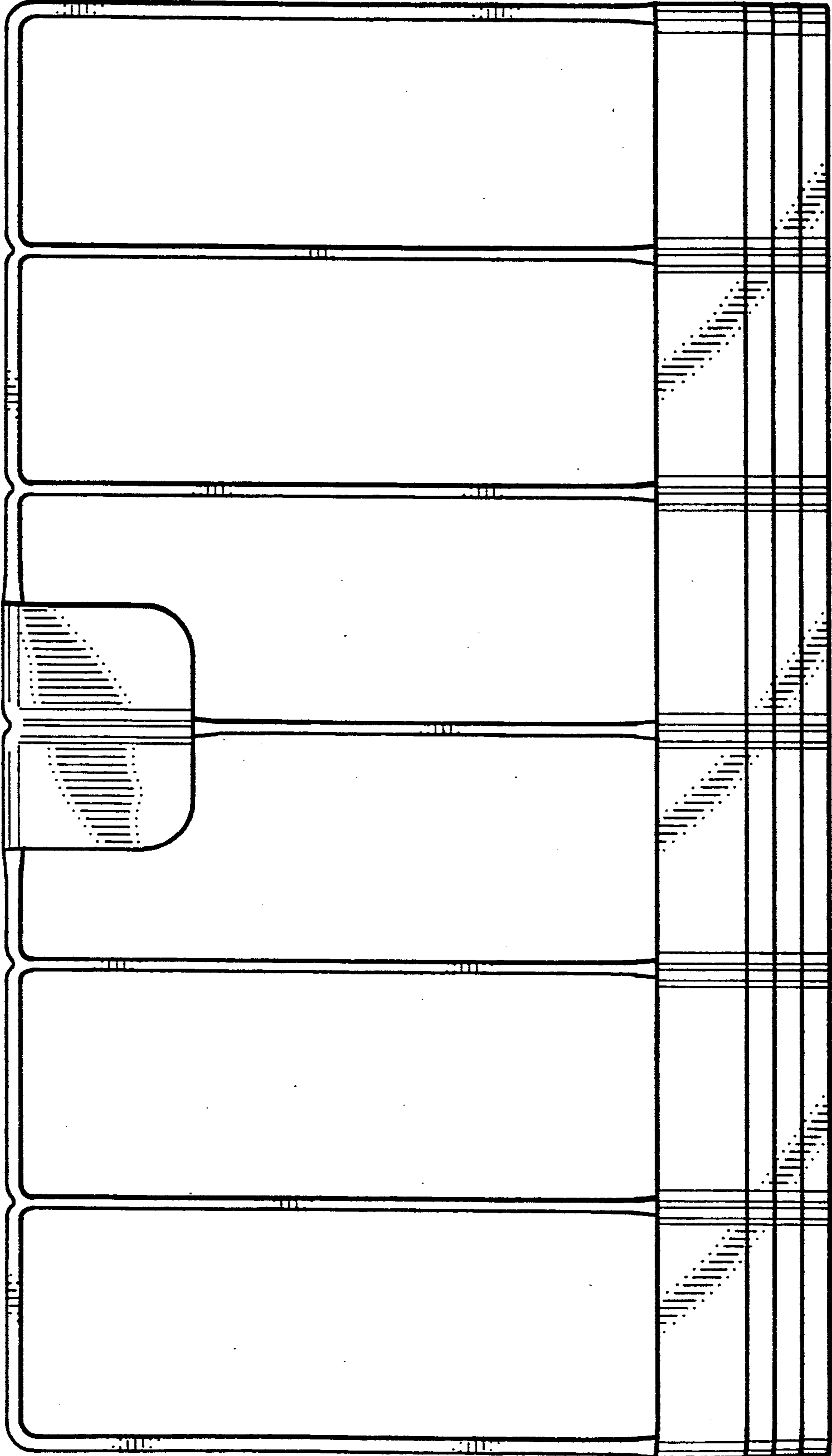

FIG. 5

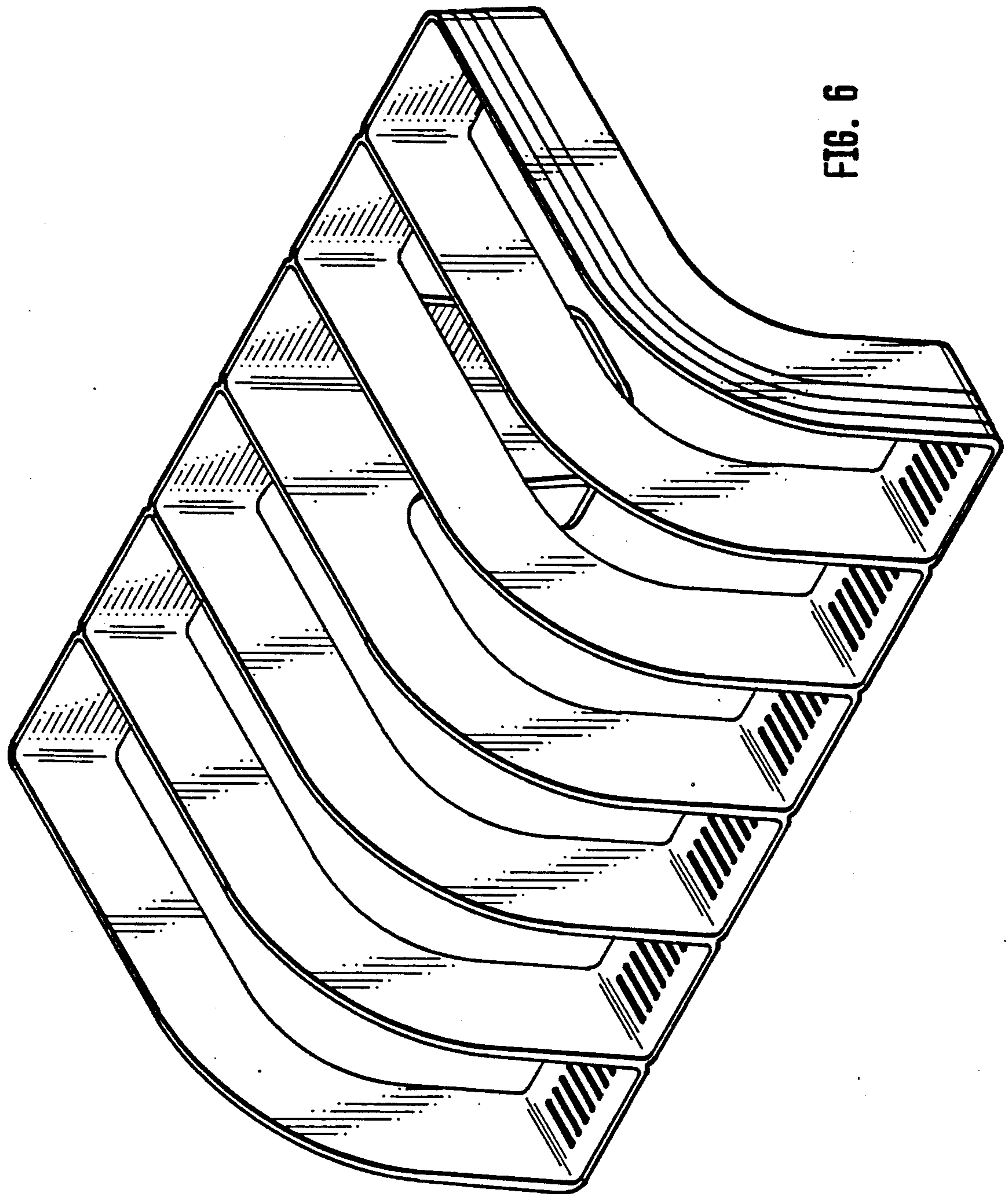

FIG. 6