



US00D328736S

United States Patent [19]

[11] Patent Number: **Des. 328,736**

Hodge

[45] Date of Patent: ** Aug. 18, 1992

[54] **COMPUTER HARD DRIVE HOUSING**

D. 308,047 5/1990 Aderman D14/100

[75] Inventor: **David Hodge, El Granada, Calif.**

Primary Examiner—Wallace R. Burke

[73] Assignee: **Compuadd Corporation, Austin, Tex.**

Assistant Examiner—Freda S. Nunn

[**] Term: **14 Years**

Attorney, Agent, or Firm—Baker & Botts

[21] Appl. No.: **558,254**

[57] **CLAIM**

The ornamental design for a computer hard drive housing, as shown and described.

[22] Filed: **Jul. 24, 1990**

DESCRIPTION

[52] U.S. Cl. **D14/109**

[58] Field of Search D14/100, 102, 104, 107,
D14/109; D13/162, 163, 184, 199;
360/97.01-99.12; 361/390-395

FIG. 1 is a top front and left side perspective view of a computer hard drive housing showing my new design; FIG. 2 is a front elevational view thereof; FIG. 3 is a left side elevational view thereof; FIG. 4 is a rear elevational view thereof; FIG. 5 is a top plan view thereof; FIG. 6 is a right side elevational view thereof; and, FIG. 7 is a bottom plan view thereof.

[56] **References Cited**

U.S. PATENT DOCUMENTS

D. 290,844 7/1987 Shibuya et al. D14/107 X

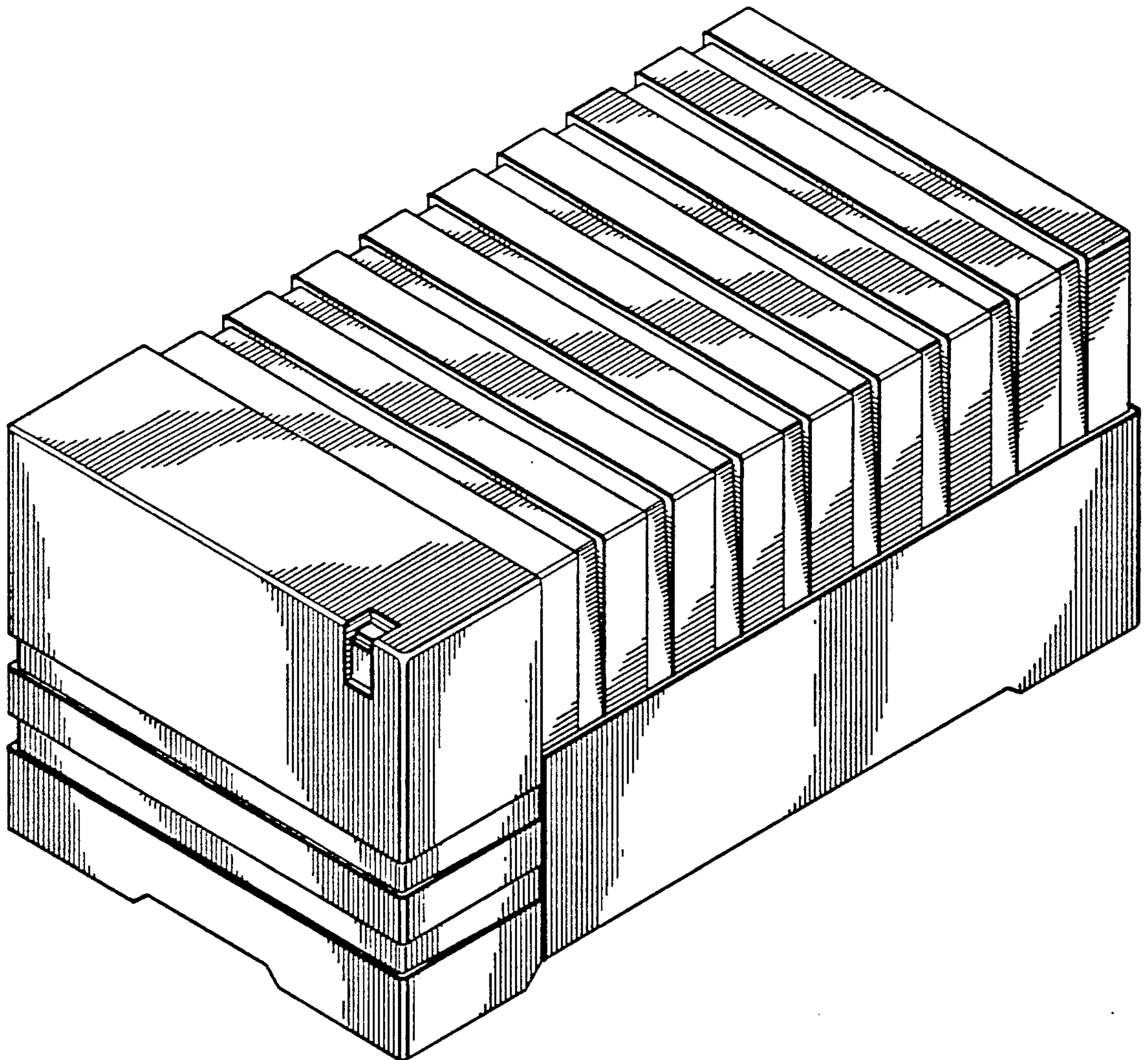

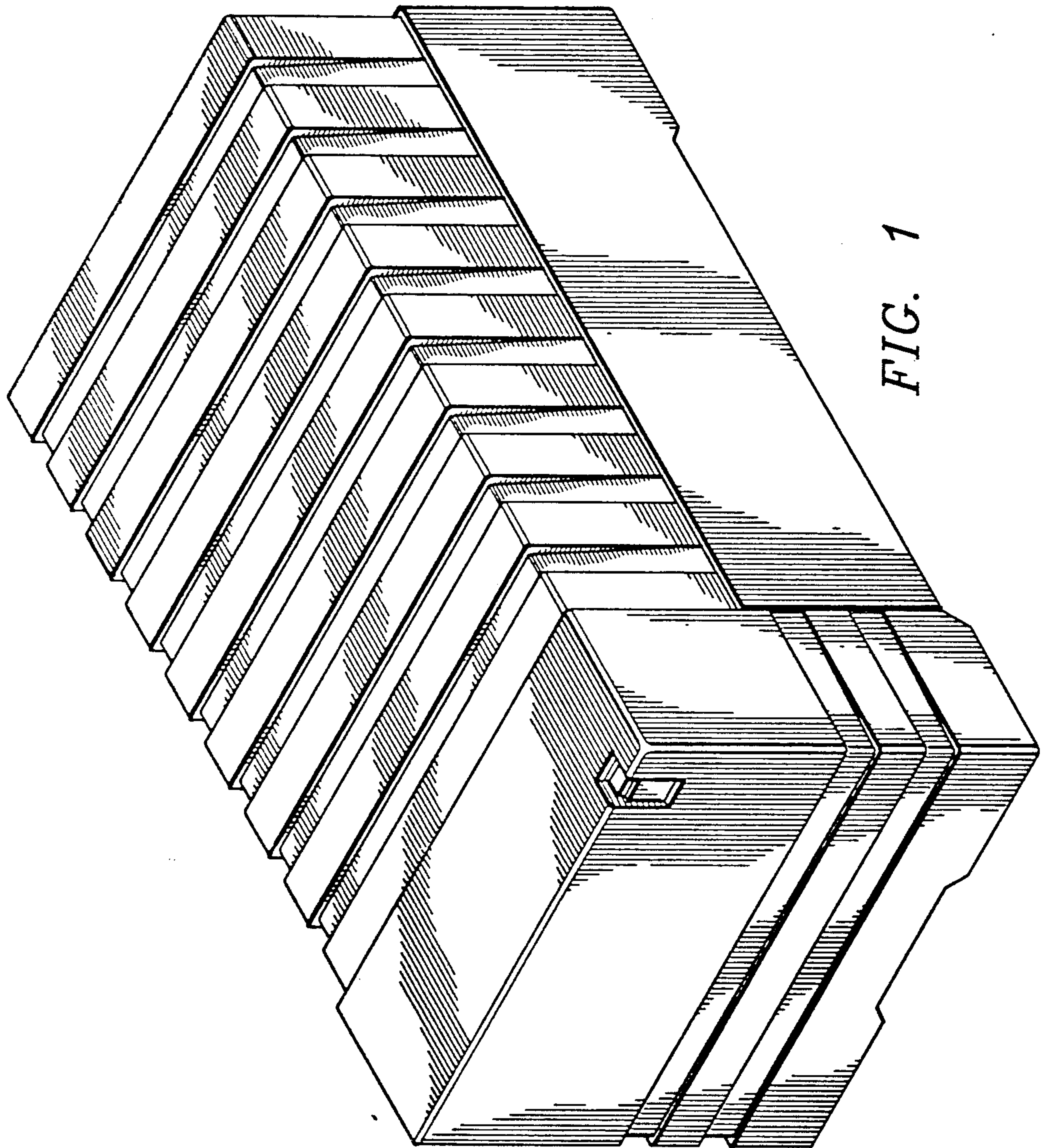

FIG. 1

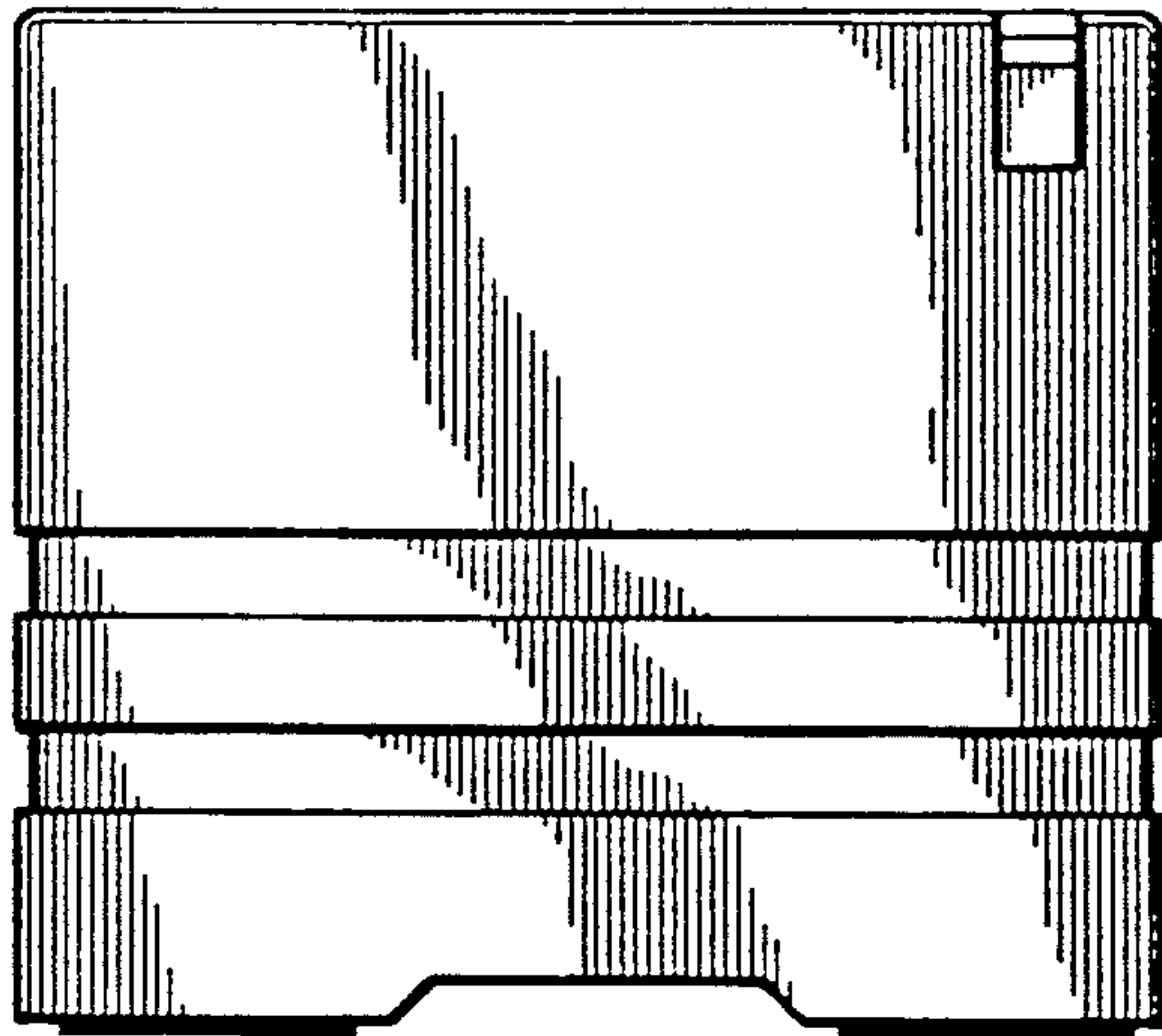

FIG. 2

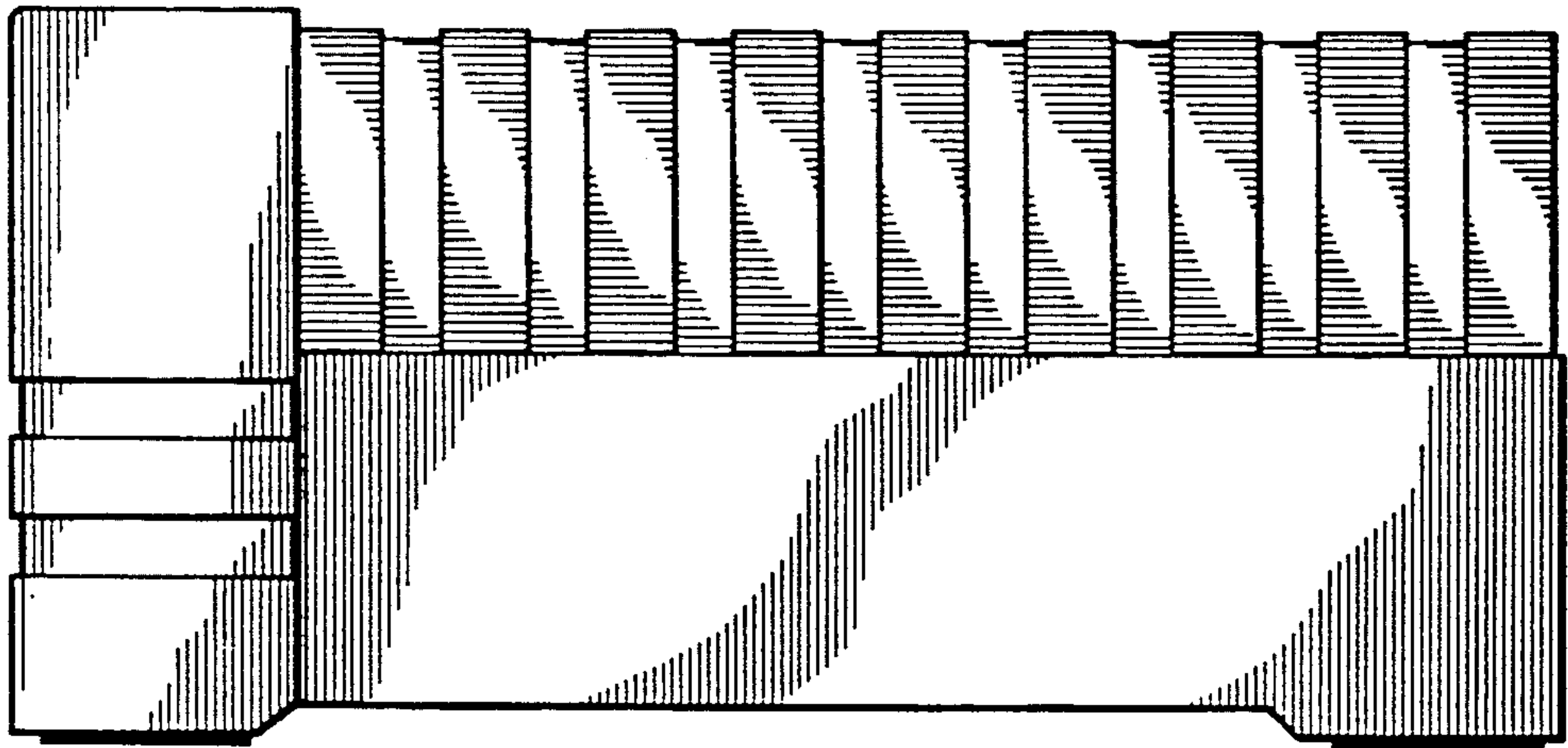

FIG. 3

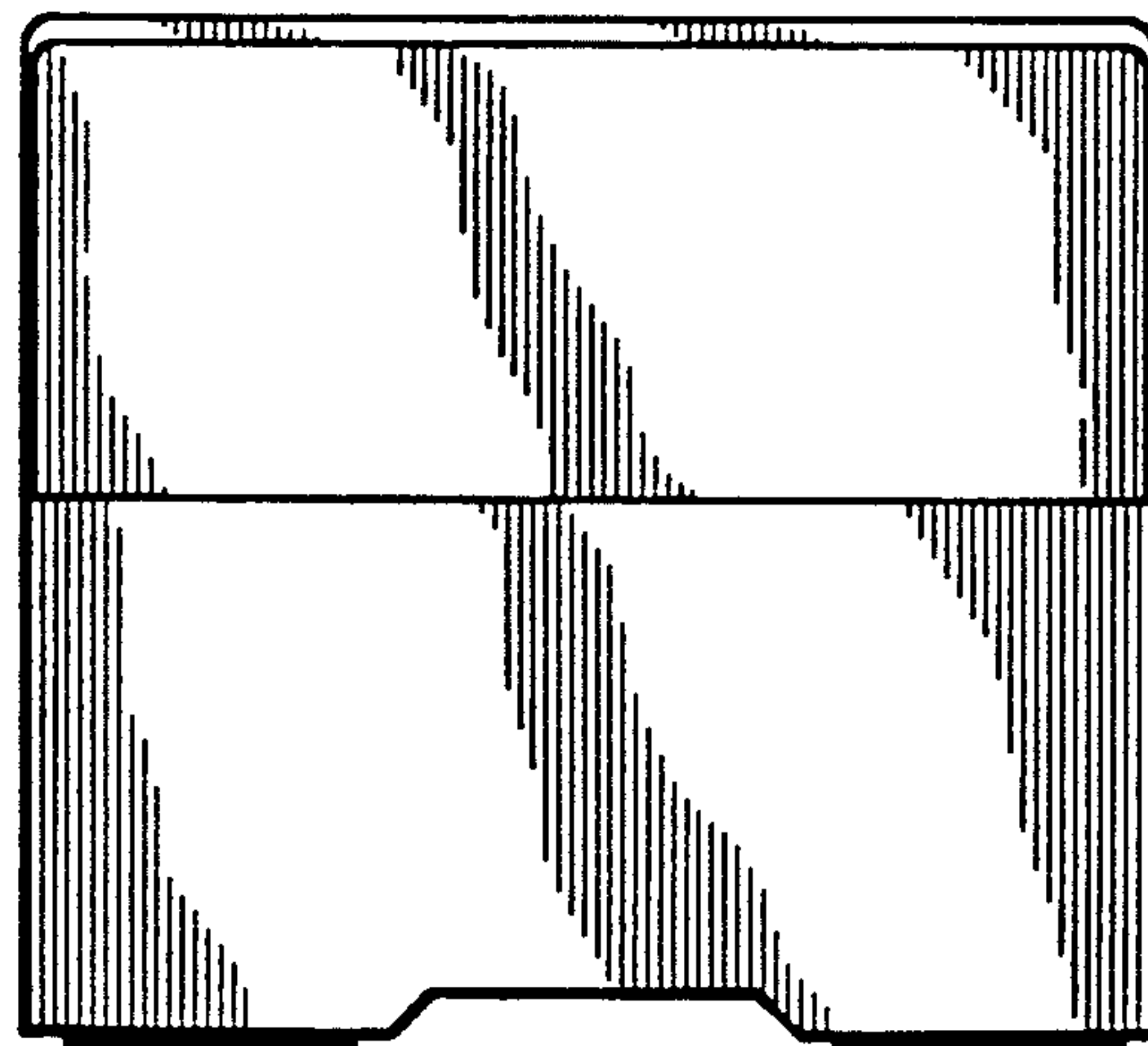

FIG. 4

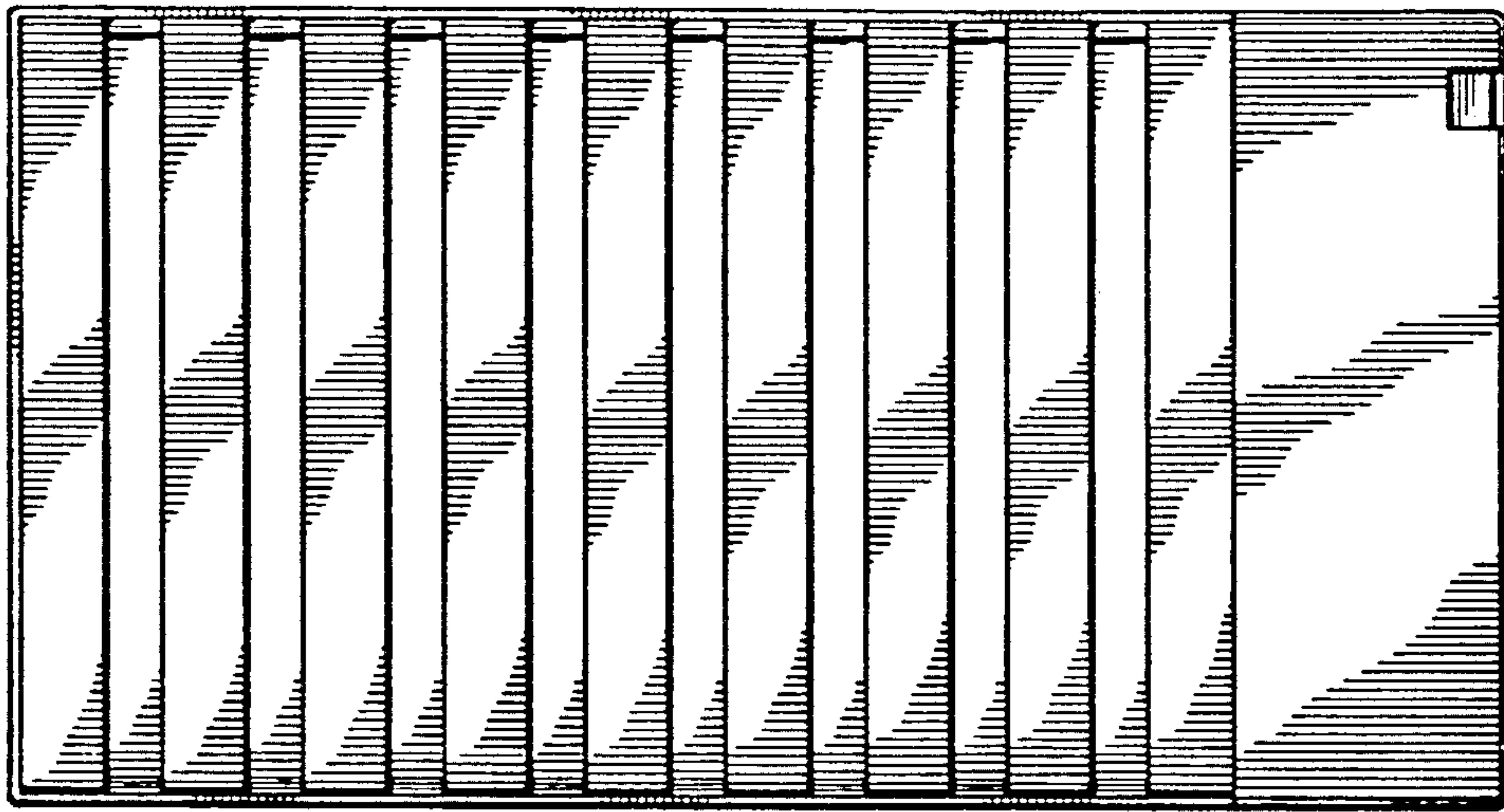

FIG. 5

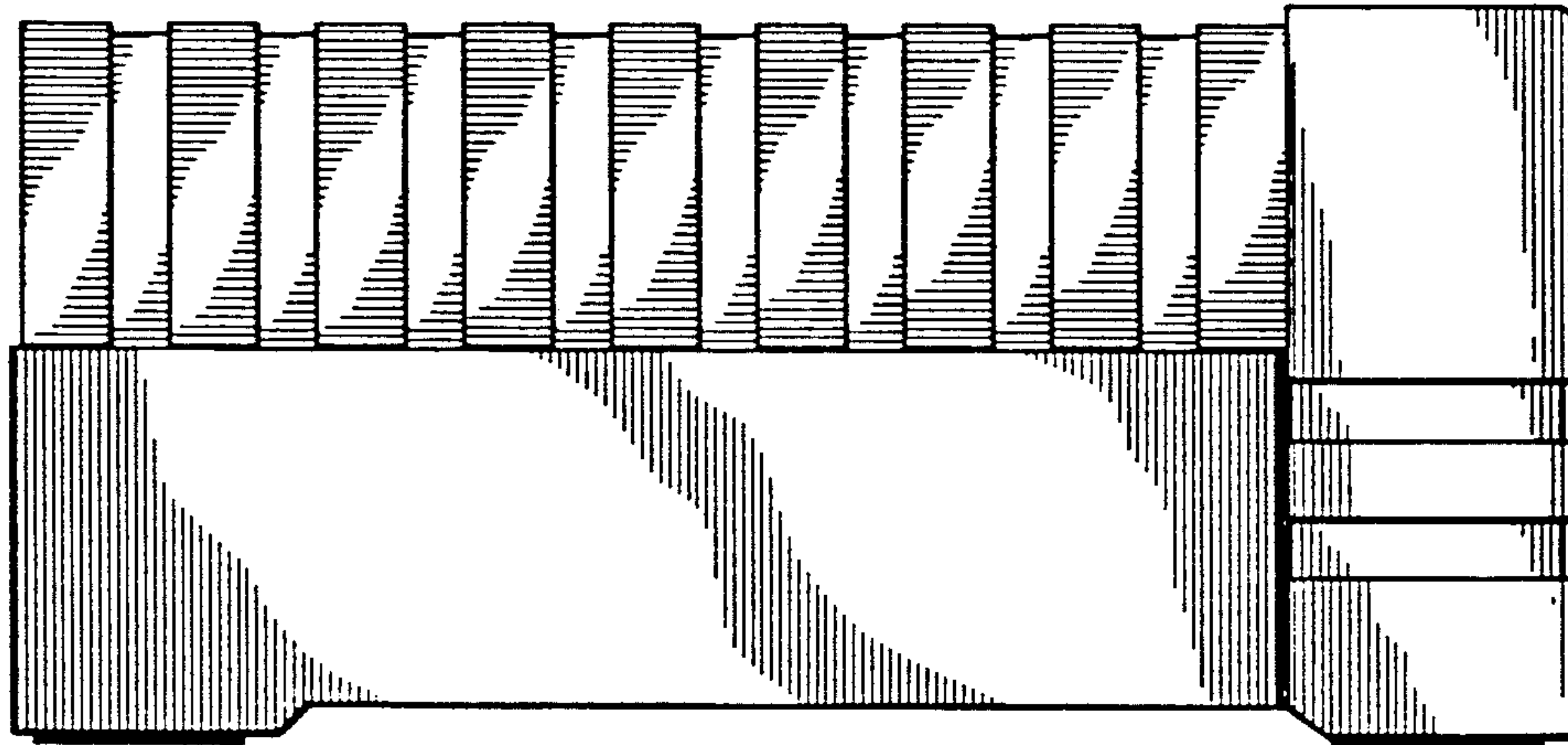

FIG. 6

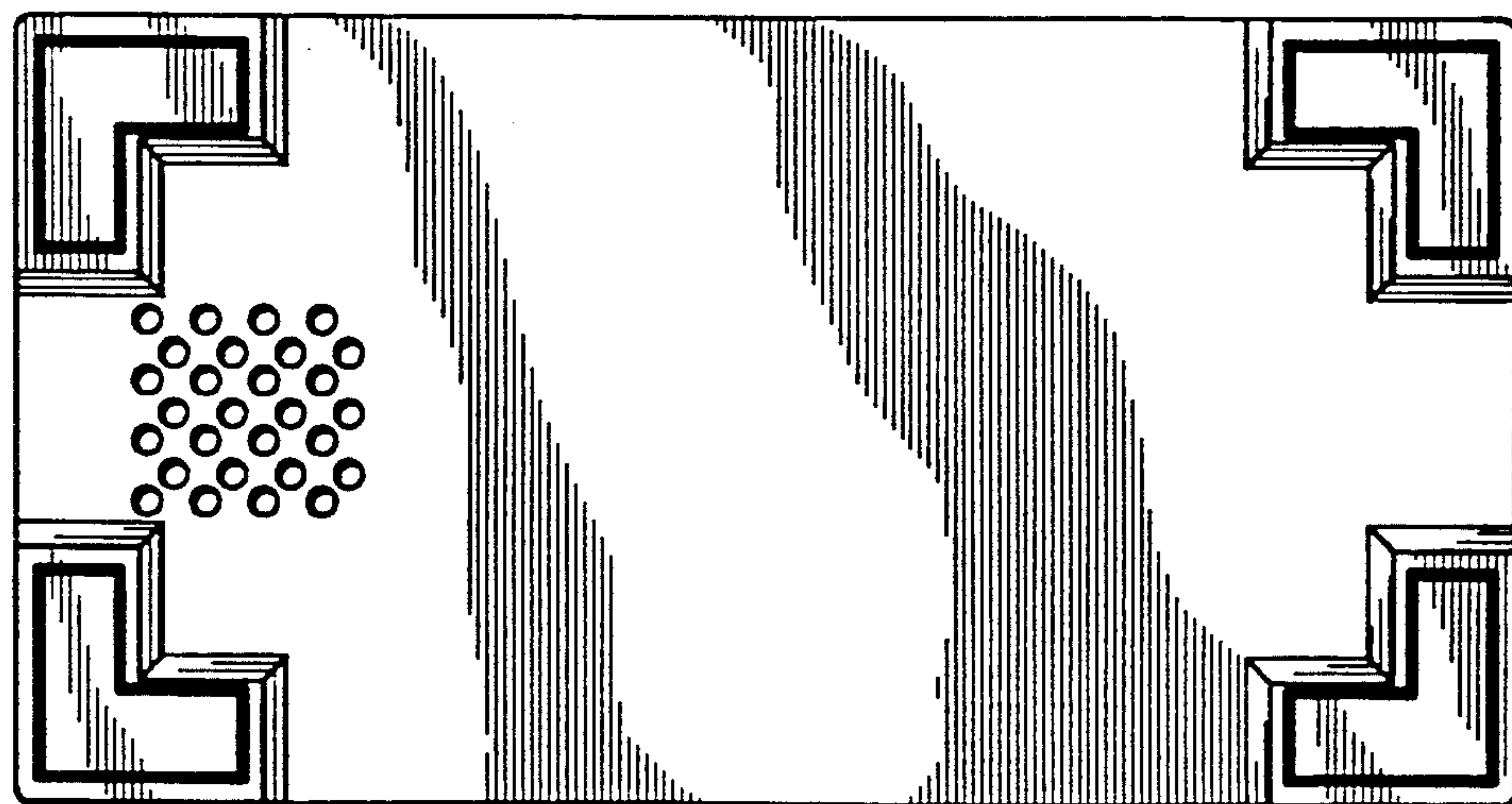

FIG. 7