



US00D328734S

United States Patent [19]

[11] Patent Number: **Des. 328,734**

Riley et al.

[45] Date of Patent: ** Aug. 18, 1992

[54] **COMPUTER HOUSING OR SIMILAR ARTICLE**

[75] Inventors: **Raymond W. Riley; Robert D. Brunner**, both of San Jose; **Kenneth D. Wood**, Woodside, all of Calif.

[73] Assignee: **Apple Computer, Inc.**, Cupertino, Calif.

[**] Term: **14 Years**

[21] Appl. No.: **586,046**

[22] Filed: **Sep. 20, 1990**

[52] U.S. Cl. **D14/100**

[58] Field of Search **D14/100, 102, 104, 107, D14/109; D13/162, 163, 184, 199; 360/97.01-99.12; 361/390-395**

[56] **References Cited**

U.S. PATENT DOCUMENTS

- D. 303,791 10/1989 Peart et al. D14/107
- D. 305,227 12/1989 Esslinger D14/100
- D. 320,006 9/1991 Ivester D14/100

Primary Examiner—Wallace R. Burke
Assistant Examiner—Freda S. Nunn
Attorney, Agent, or Firm—Franklyn C. Weiss

[57] **CLAIM**

The ornamental design for a computer housing or similar article, as shown and described.

DESCRIPTION

FIG. 1 is a top front and right side perspective view of a computer housing or similar article showing our new design;

FIG. 2 is a front elevational view thereof on an enlarged scale;

FIG. 3 is a rear elevational view thereof on an enlarged scale;

FIG. 4 is a left side elevational view thereof on an enlarged scale;

FIG. 5 is a right side elevational view thereof on an enlarged scale;

FIG. 6 is a top plan view thereof on an enlarged scale; and,

FIG. 7 is a bottom plan view thereof on an enlarged scale.

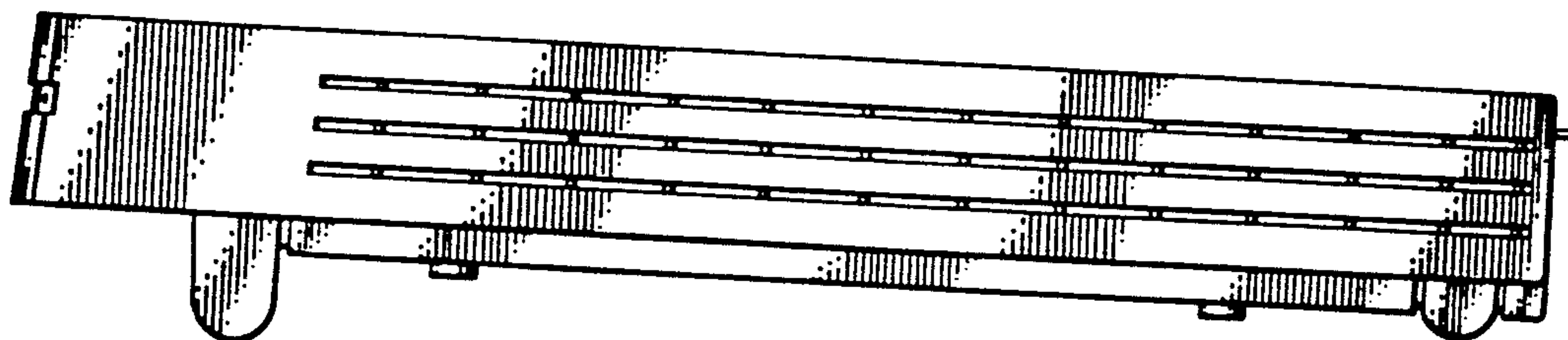
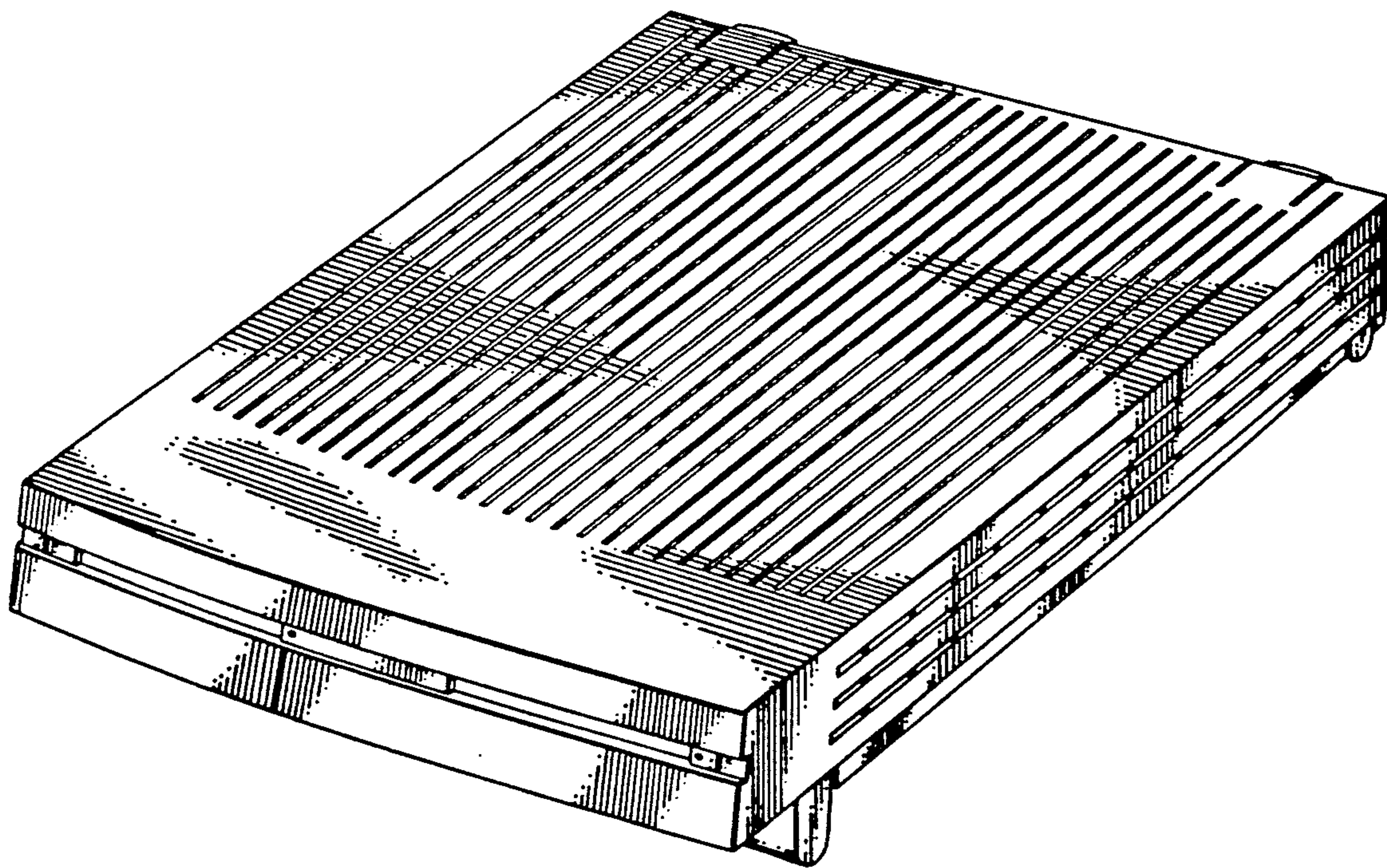

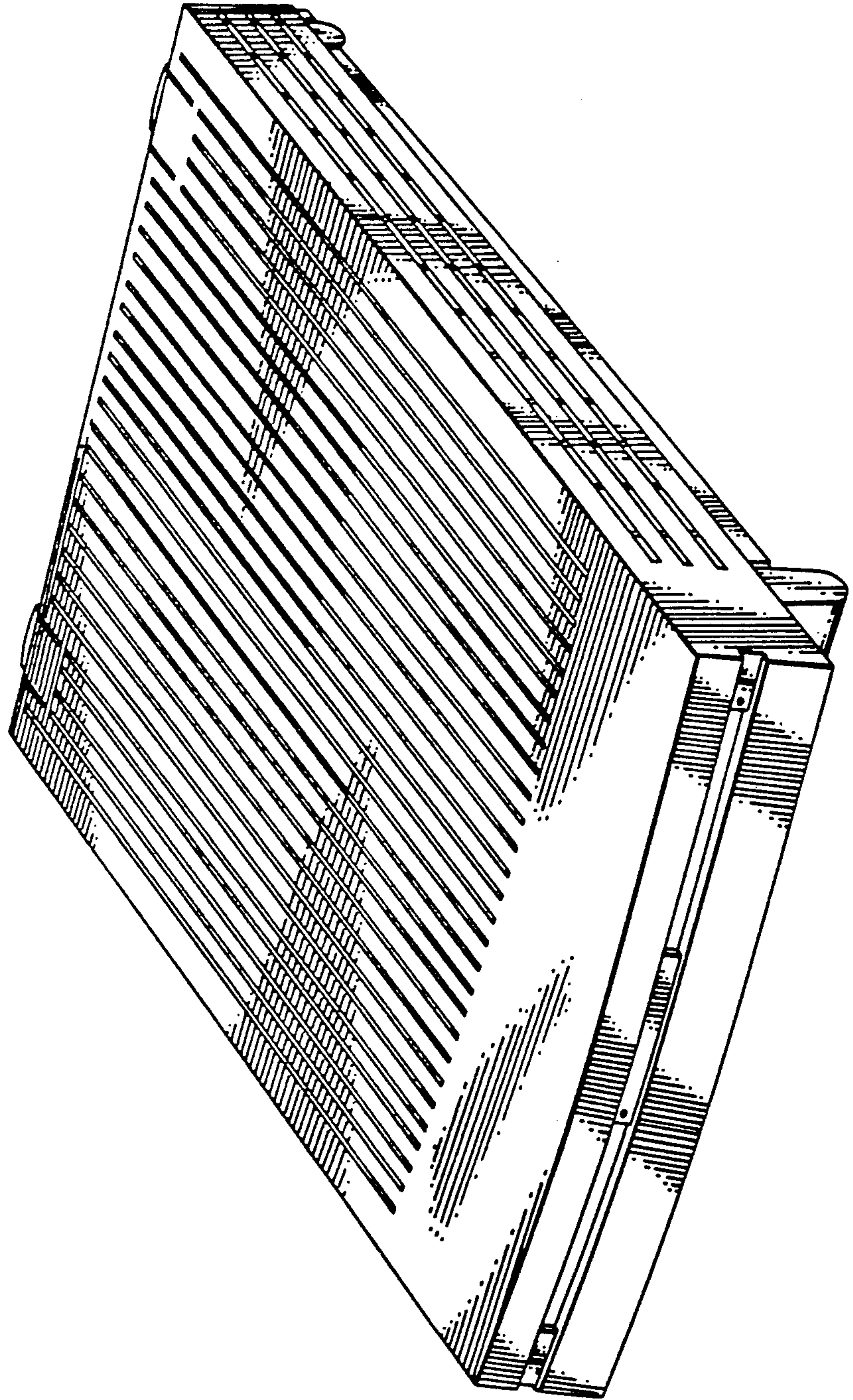

FILE

FIG — **N**

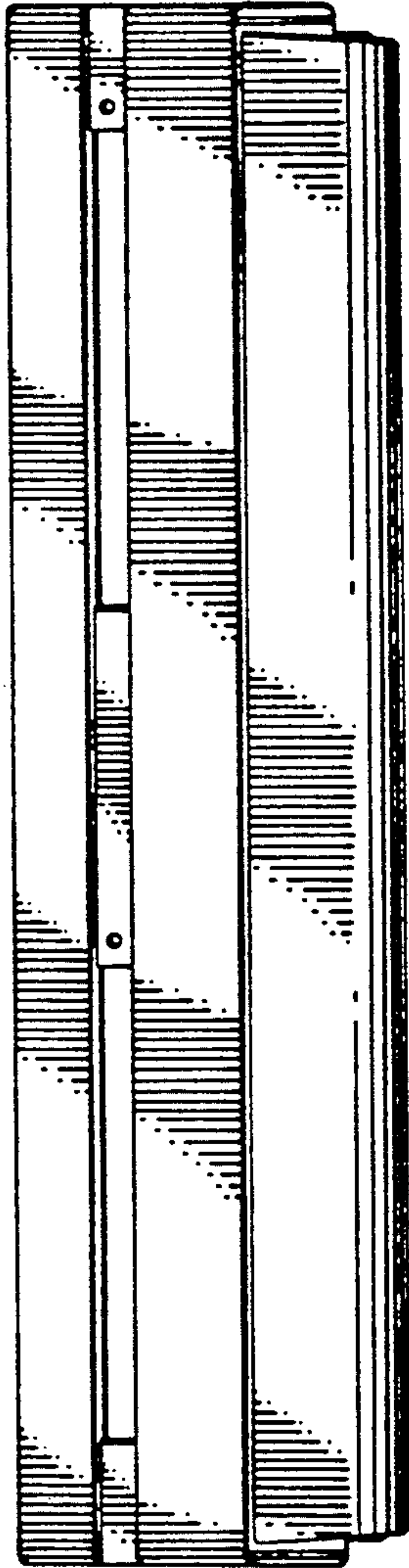
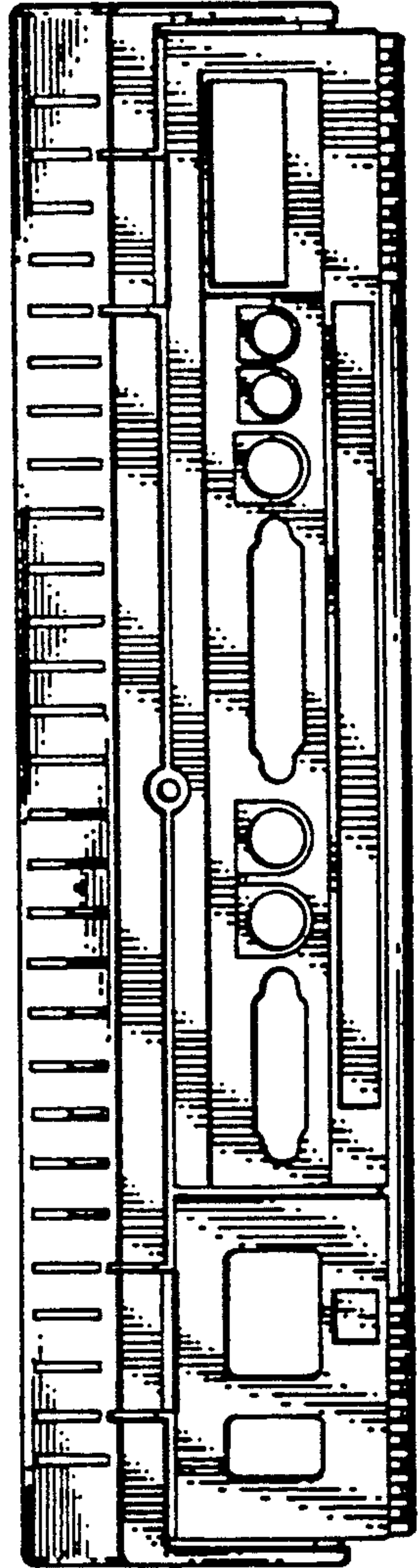

FIG — **M**



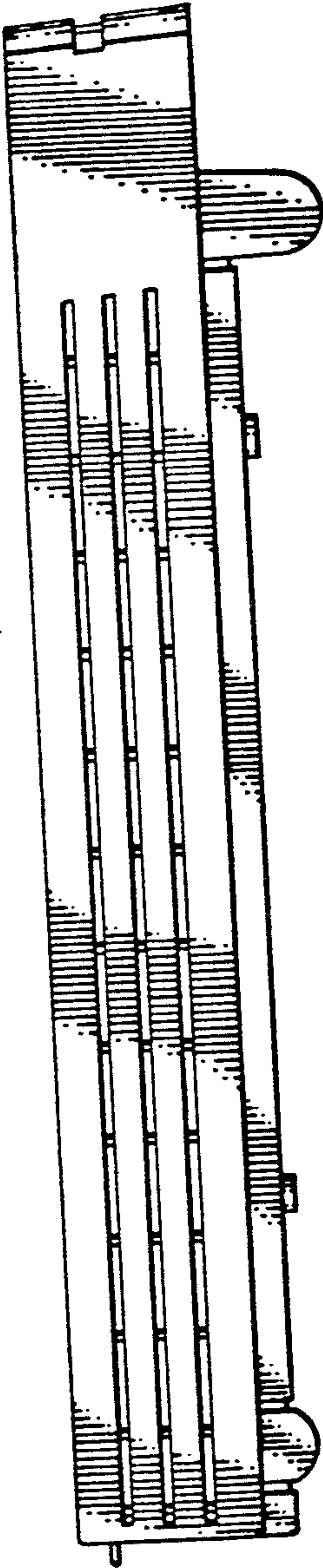

FIG. 4

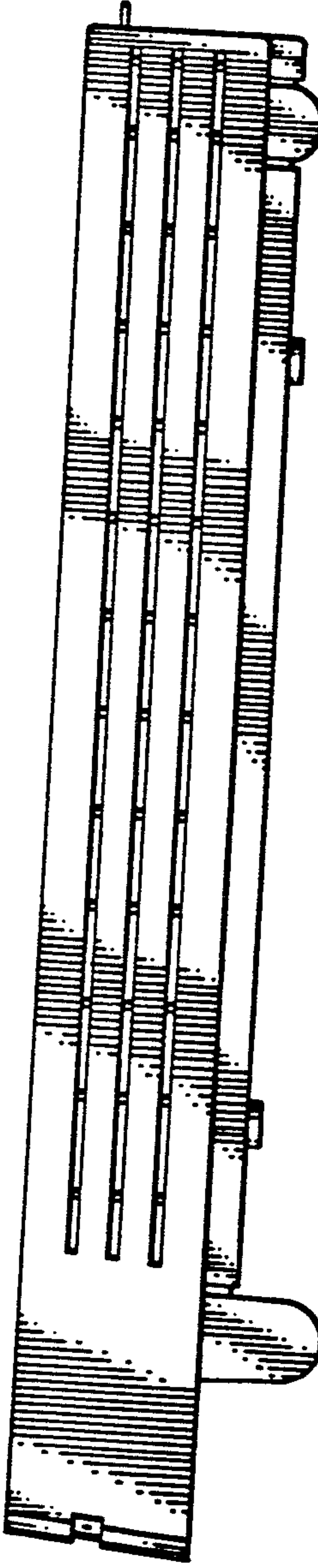

FIG. 5

FIG 6

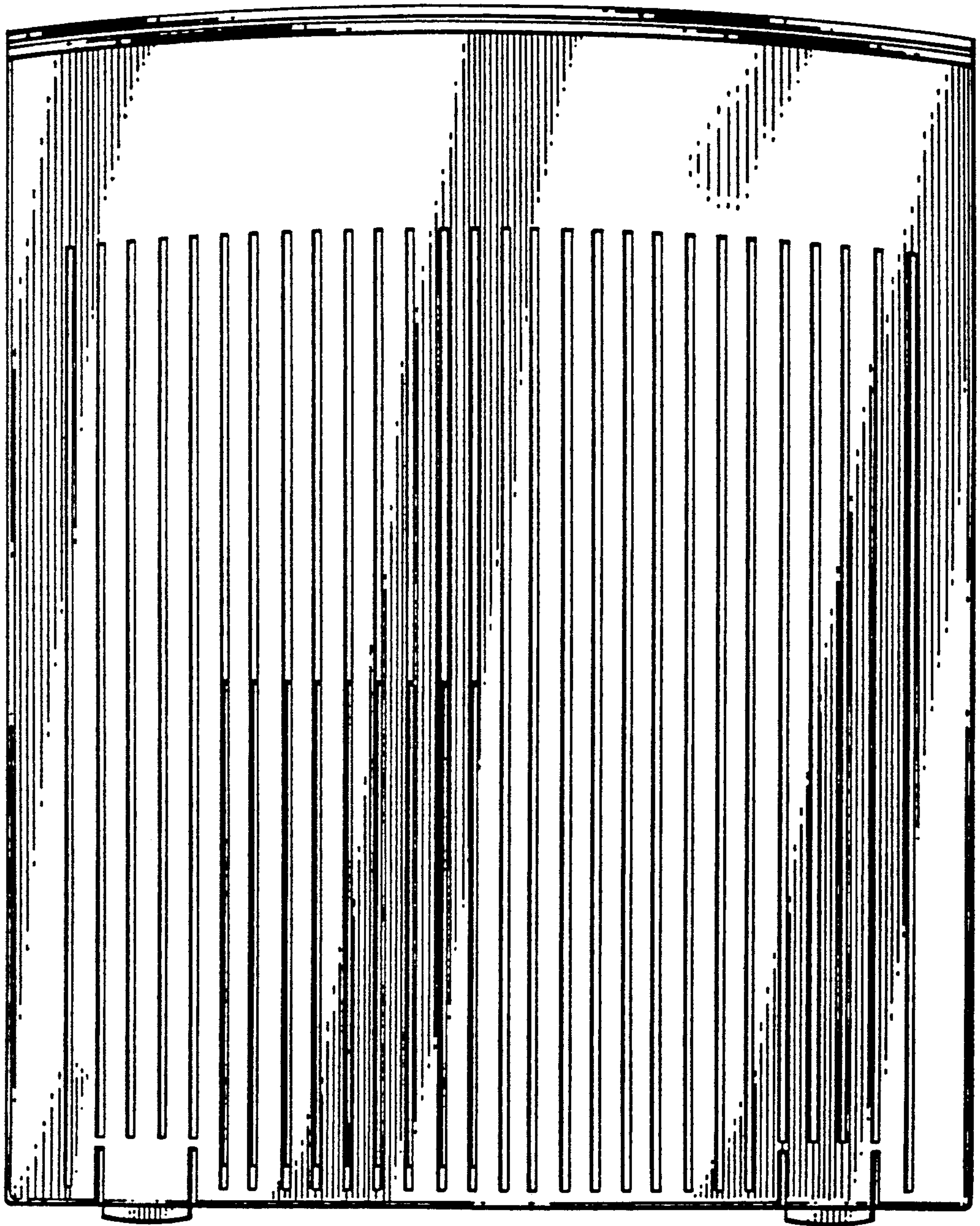

FIG 7

