



US00D328727S

United States Patent [19]

[11] Patent Number: **Des. 328,727**

Wallhead

[45] Date of Patent: **** Aug. 18, 1992**

[54] SLEDGE CANOPY

[76] Inventor: **Malcolm Wallhead, Lot 12, Watsons Road, Kettering, Tasmania 7155, Australia**

[**] Term: **14 Years**

[21] Appl. No.: **482,689**

[22] Filed: **Feb. 21, 1990**

[30] Foreign Application Priority Data

Oct. 13, 1989 [AU] Australia 3380/89

[52] U.S. Cl. D12/6; D12/11; D25/16

[58] Field of Search D12/6, 7, 11; D25/1, D25/16; 280/19.1, 18; 296/173, 158, 161, 170

[56] References Cited

U.S. PATENT DOCUMENTS

D. 202,880 11/1965 Cameron et al. D25/16

D. 223,705	5/1972	McCutcheon	D25/16
2,464,884	3/1949	Noyes	135/901 X
3,603,419	9/1971	Riddle	280/18 X
4,070,722	1/1978	Sutherland	135/901 X
4,872,470	10/1989	Hayashida et al.	135/109 X

Primary Examiner—A. Hugo Word

Assistant Examiner—Doris V. Coles

[57] CLAIM

The ornamental design for a sledge canopy, as shown and described.

DESCRIPTION

FIG. 1 is a front perspective view of a sledge canopy showing my new design;
 FIG. 2 is a rear perspective view thereof;
 FIG. 3 is a left side elevational view, the right side being a mirror image thereof;
 FIG. 4 is a top plan view thereof;
 FIG. 5 is a rear elevational view thereof; and,
 FIG. 6 is a front elevational thereof;

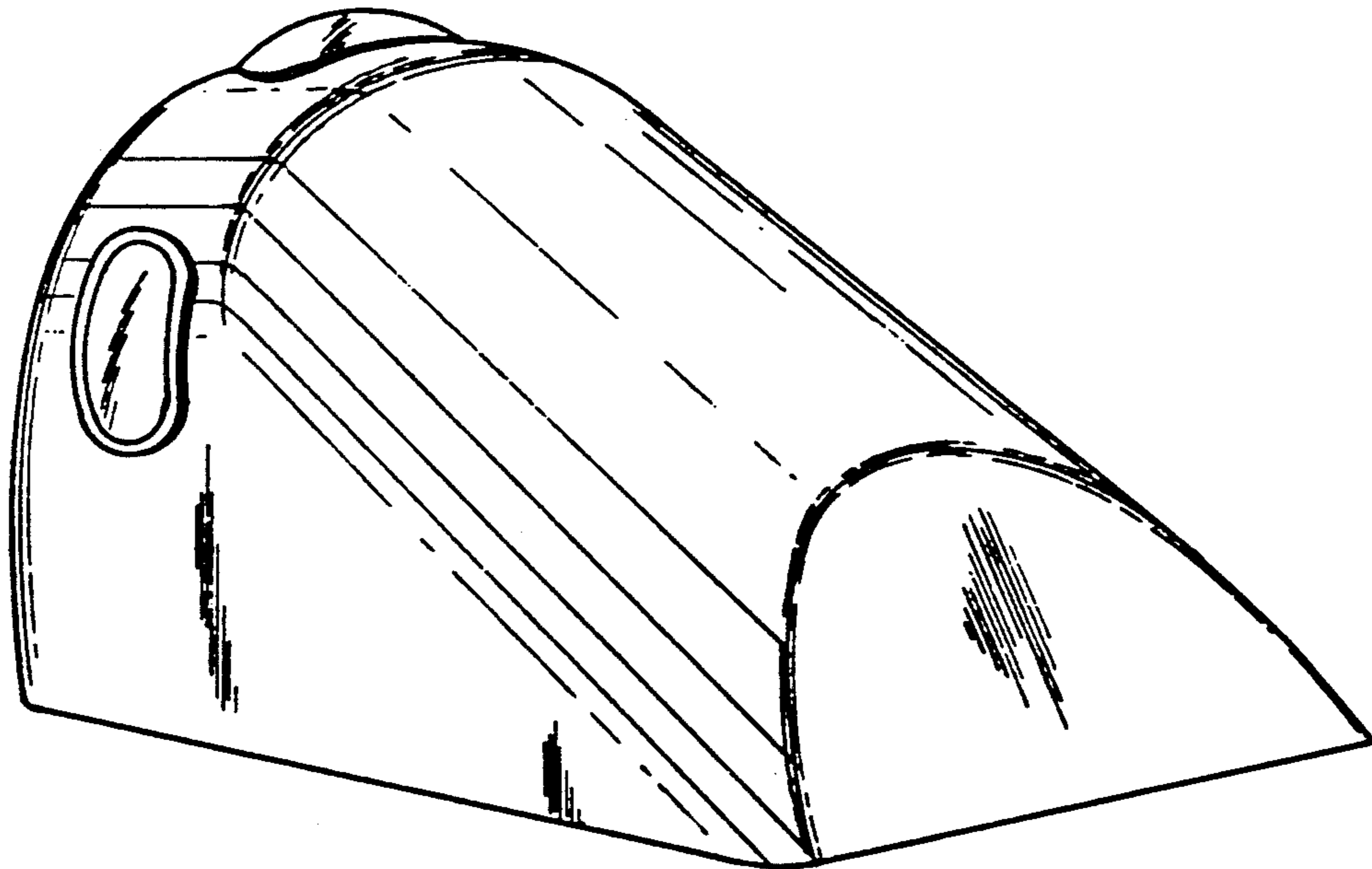

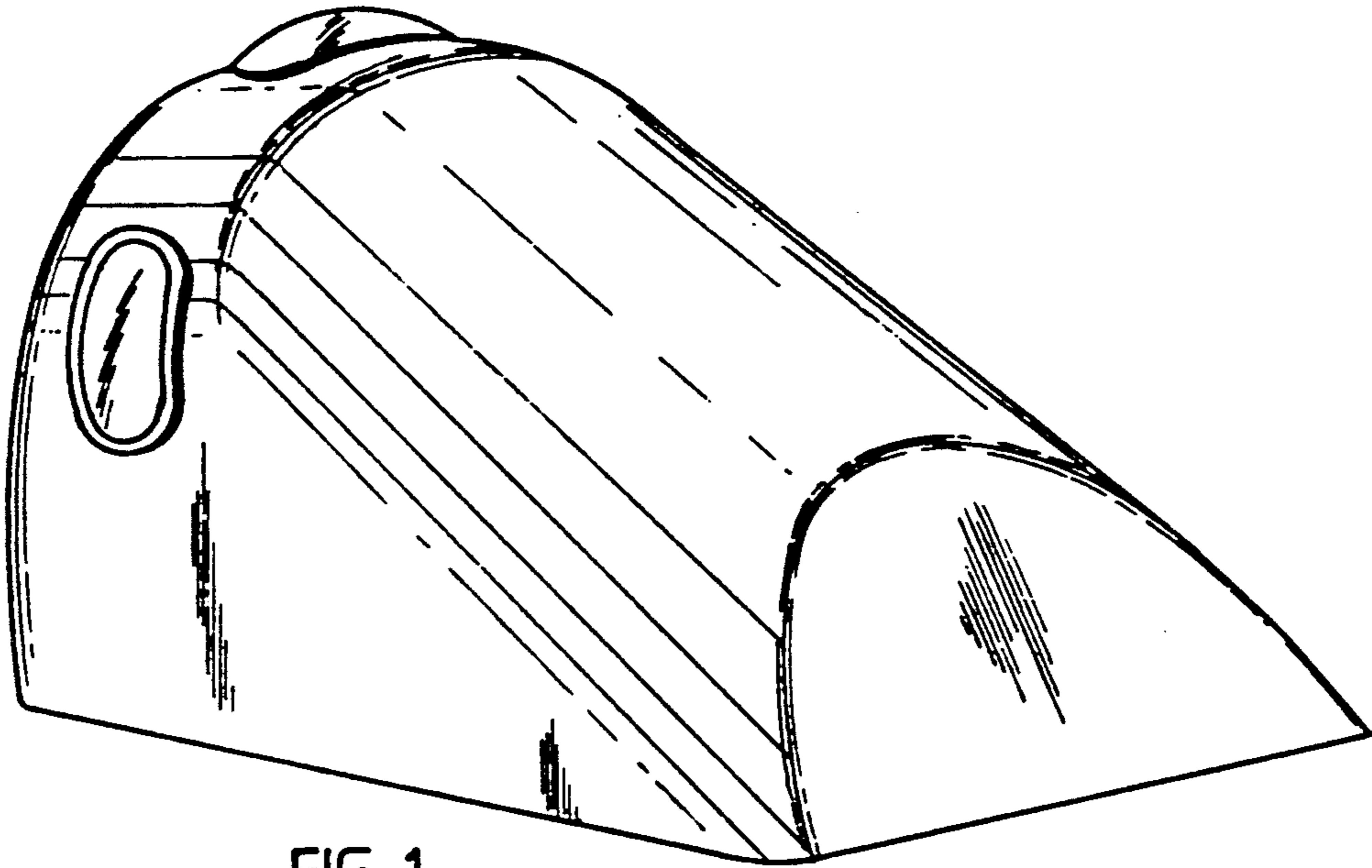

FIG 1

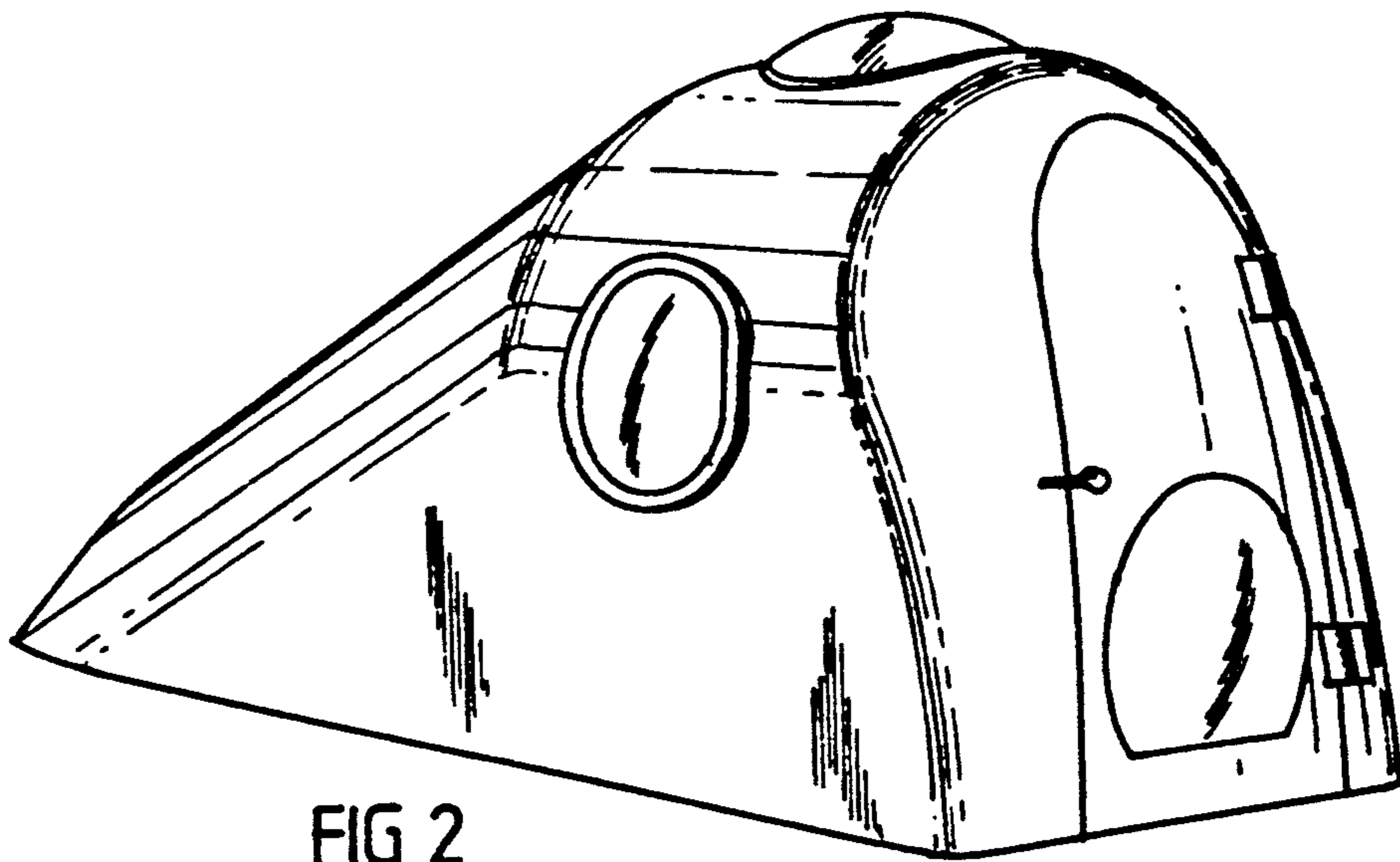

FIG 2

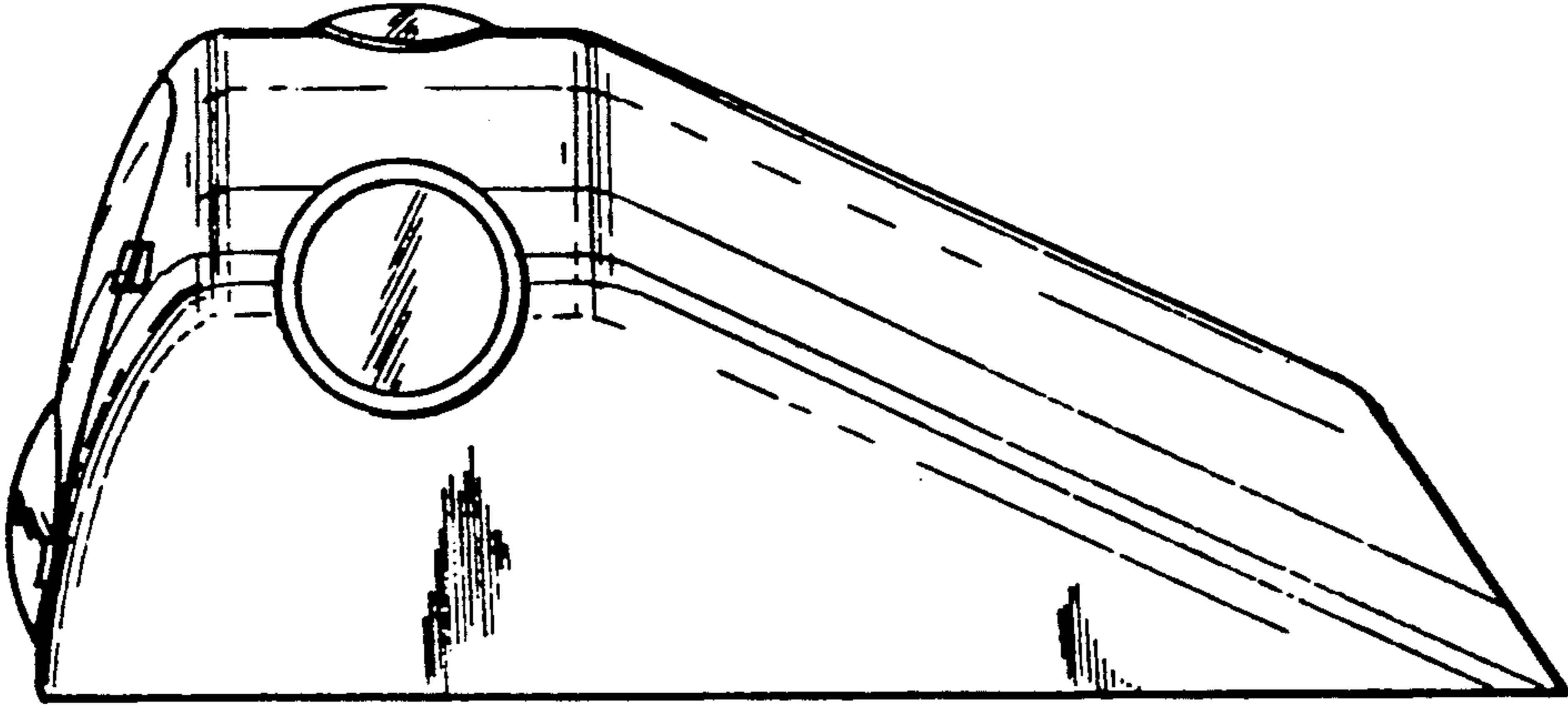

FIG 3

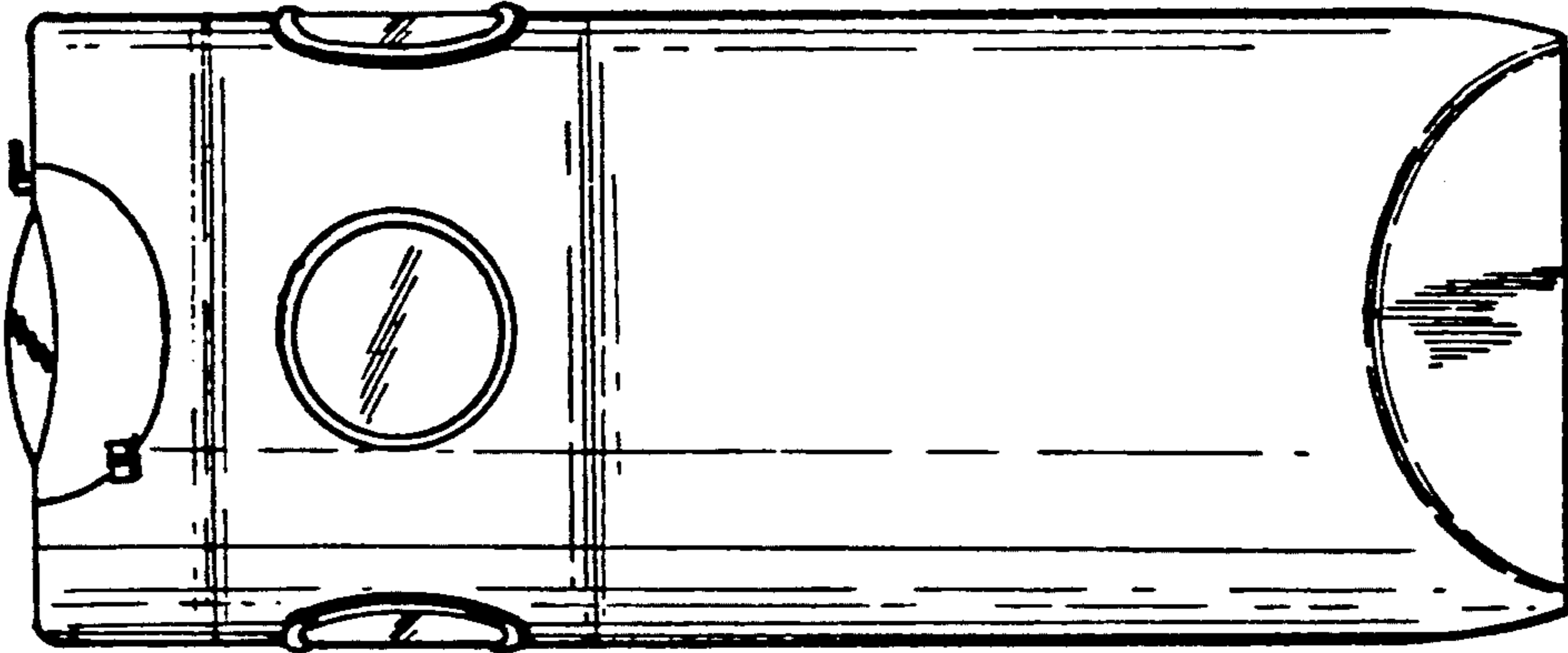

FIG 4

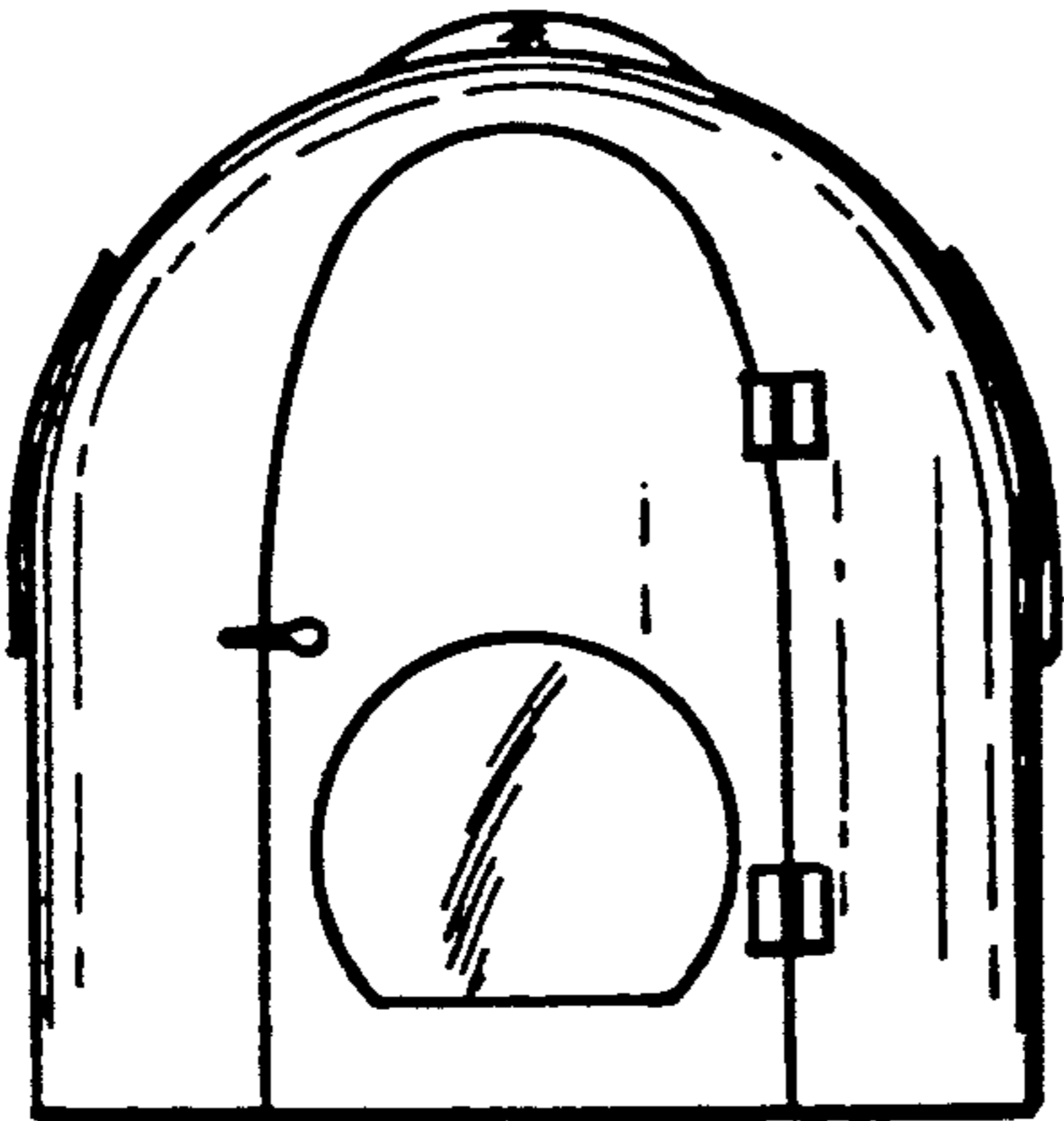

FIG 5

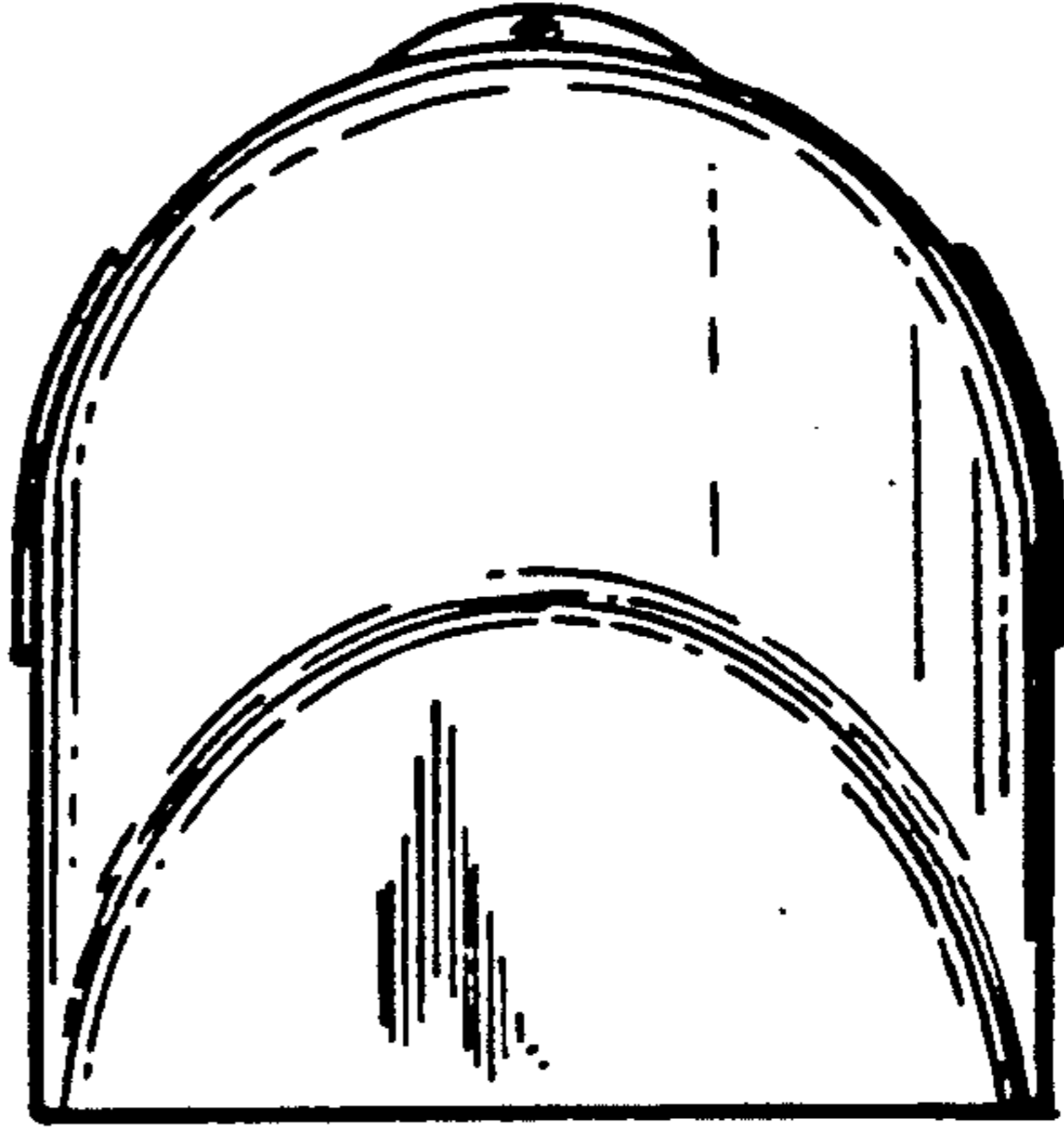

FIG 6