



US00D328674S

United States Patent [19]

[11] Patent Number: **Des. 328,674**

Dokoupil et al.

[45] Date of Patent: **** Aug. 18, 1992**

[54] COMPACT DISC DISPLAYER

DESCRIPTION

[75] Inventors: **James Dokoupil, Liverpool; Robert Ackley, Brewerton, both of N.Y.; Stanleigh Wells, Bridgewater, Conn.**

FIG. 1 is a perspective of a compact disc displayer showing our new design;

FIG. 2 is a front elevational view, the rear being identical thereto;

[73] Assignee: **The Croydon Company, Liverpool, N.Y.**

FIG. 3 is a left side elevational view, the right side being identical thereto;

[**] Term: **14 Years**

FIG. 4 is a top plan view thereof;

[21] Appl. No.: **604,414**

FIG. 5 is a bottom plan view thereof;

[22] Filed: **Oct. 29, 1990**

FIG. 6 is a front elevational view of a second embodiment of the compact disc displayer shown in FIG. 1; the rear being identical thereto;

[52] U.S. Cl. **D6/407; D6/461**

FIG. 7 is a front elevational view of a third embodiment of the compact disc displayer shown in FIG. 1; the rear being identical thereto;

[58] Field of Search **D6/407, 455, 457, 458, D6/461; 211/13; 206/387; D3/35; 312/9-11**

FIG. 8 is a front elevational view of a fourth embodiment of the compact disc displayer shown in FIG. 1; the rear being identical thereto;

[56] References Cited

U.S. PATENT DOCUMENTS

D. 180,029	4/1957	Mason et al.	D6/408
D. 199,942	12/1964	Tintary	D6/461
D. 211,430	6/1968	Balos	D6/407
D. 216,283	12/1969	Ferro	D6/461
D. 234,475	3/1975	Markus	D6/461 X
D. 240,384	7/1976	Rumble et al.	D6/407 X
D. 250,791	1/1979	Mauri	D3/35

FIG. 9 is an enlarged cross sectional view of a shelf taken along the center;

FIG. 10 is a perspective view of a fifth embodiment of the compact disc displayer shown in FIG. 1;

FIG. 11 is a front elevational view, the rear being identical thereto;

Primary Examiner—Carmen H. Vales-Lado
Attorney, Agent, or Firm—Staas & Halsey

FIG. 12 is a top plan view thereof;

FIG. 13 is a bottom plan view thereof;

[57] CLAIM

The ornamental design for a compact disc displayer, as shown and described.

FIG. 14 is a front elevational view of sixth embodiment of the compact disc displayer shown in FIG. 1, the rear being identical thereto;

FIG. 15 is a front elevational view of seventh embodiment of the compact disc displayer shown in FIG. 1, the rear being identical thereto; and,

FIG. 16 is a cross sectional view taken along line 16—16 of FIG. 14.

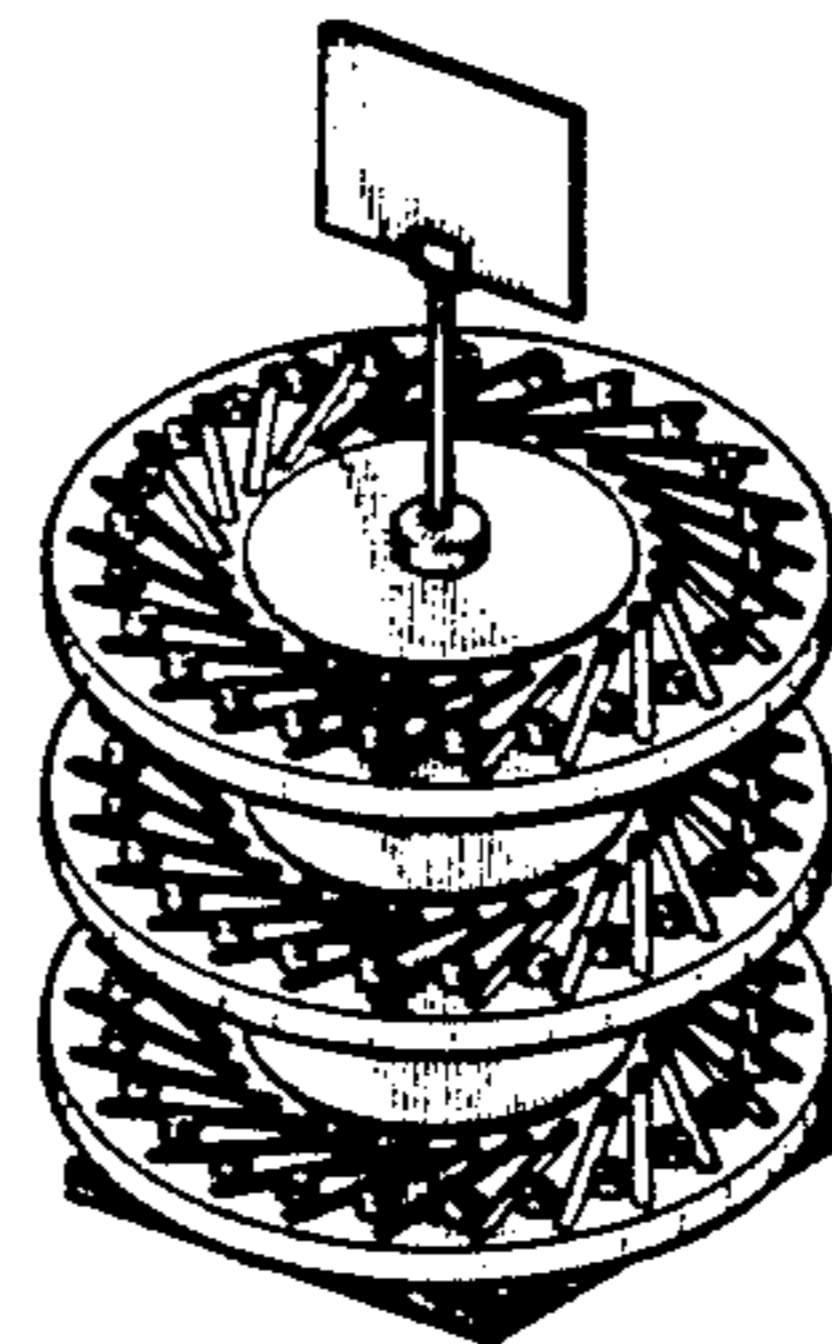
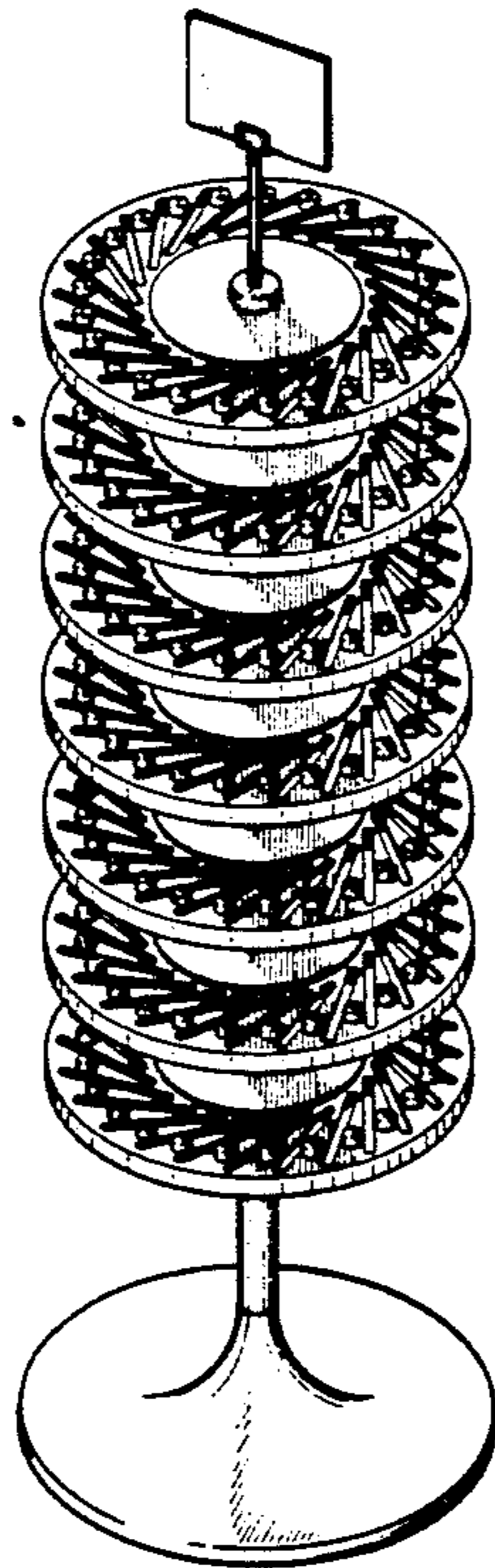

FIG. 1

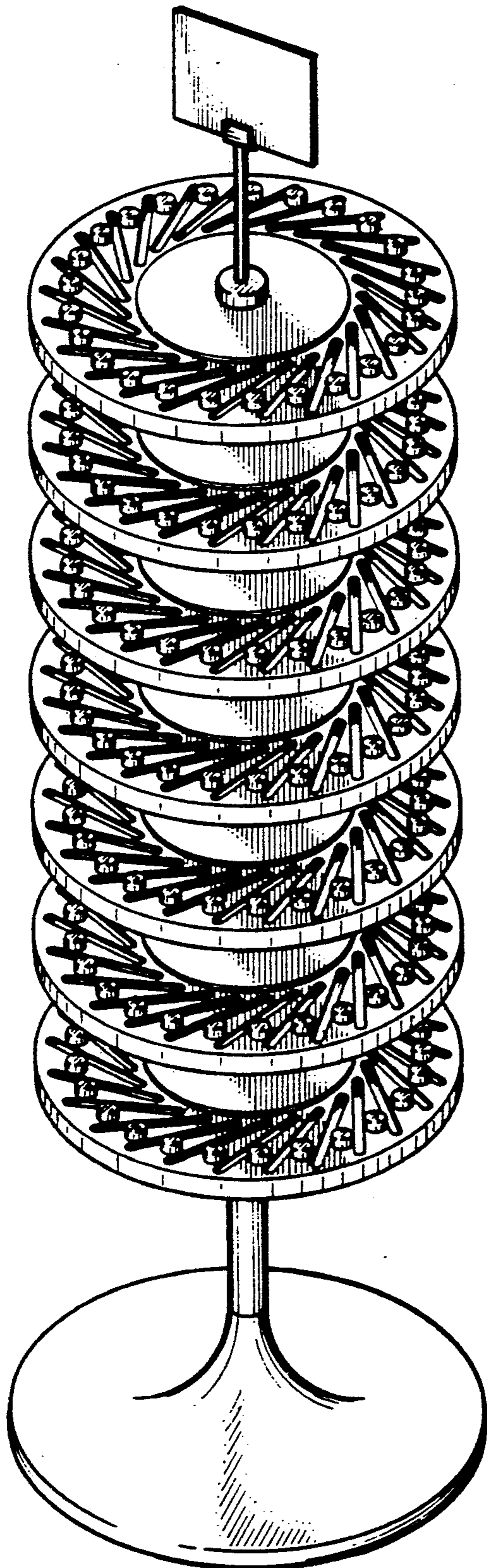

FIG. 2

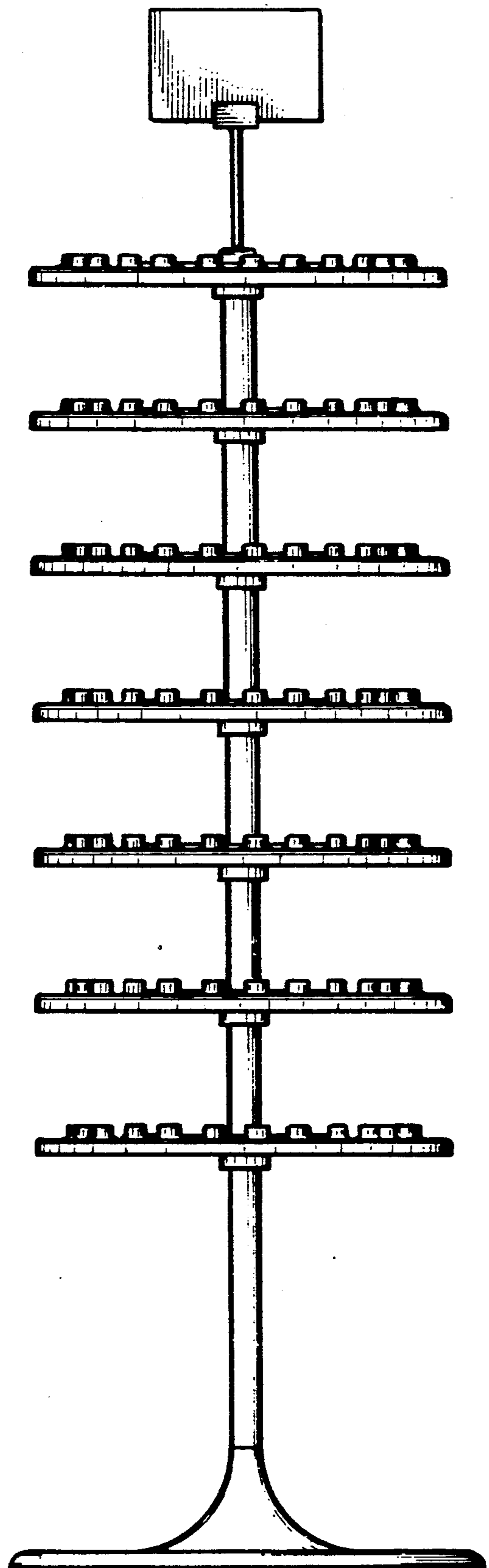

FIG. 3

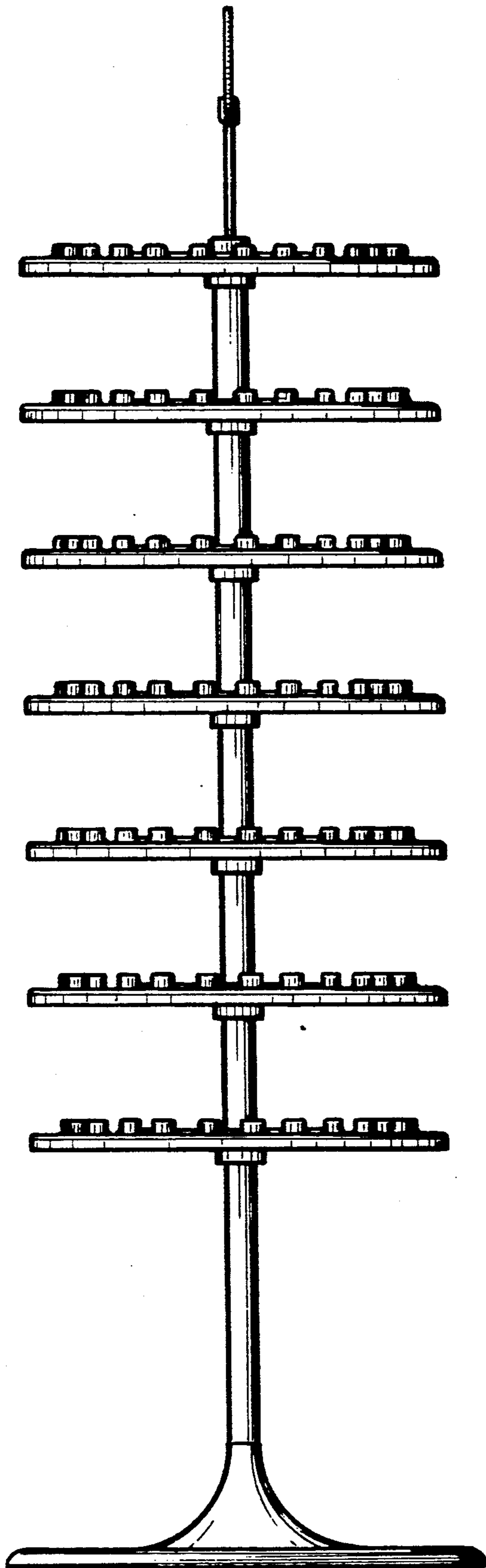

FIG. 4

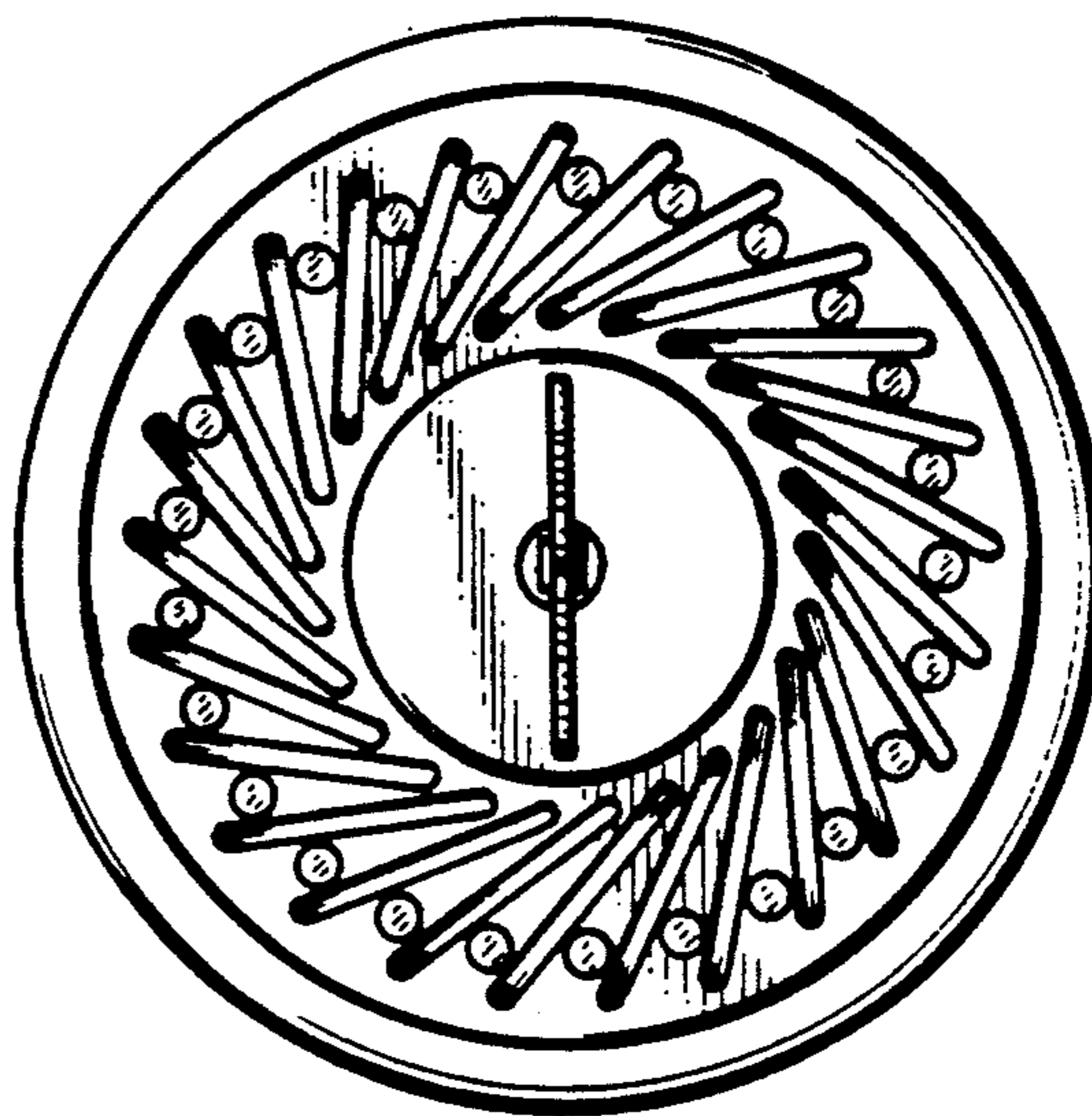

FIG. 5

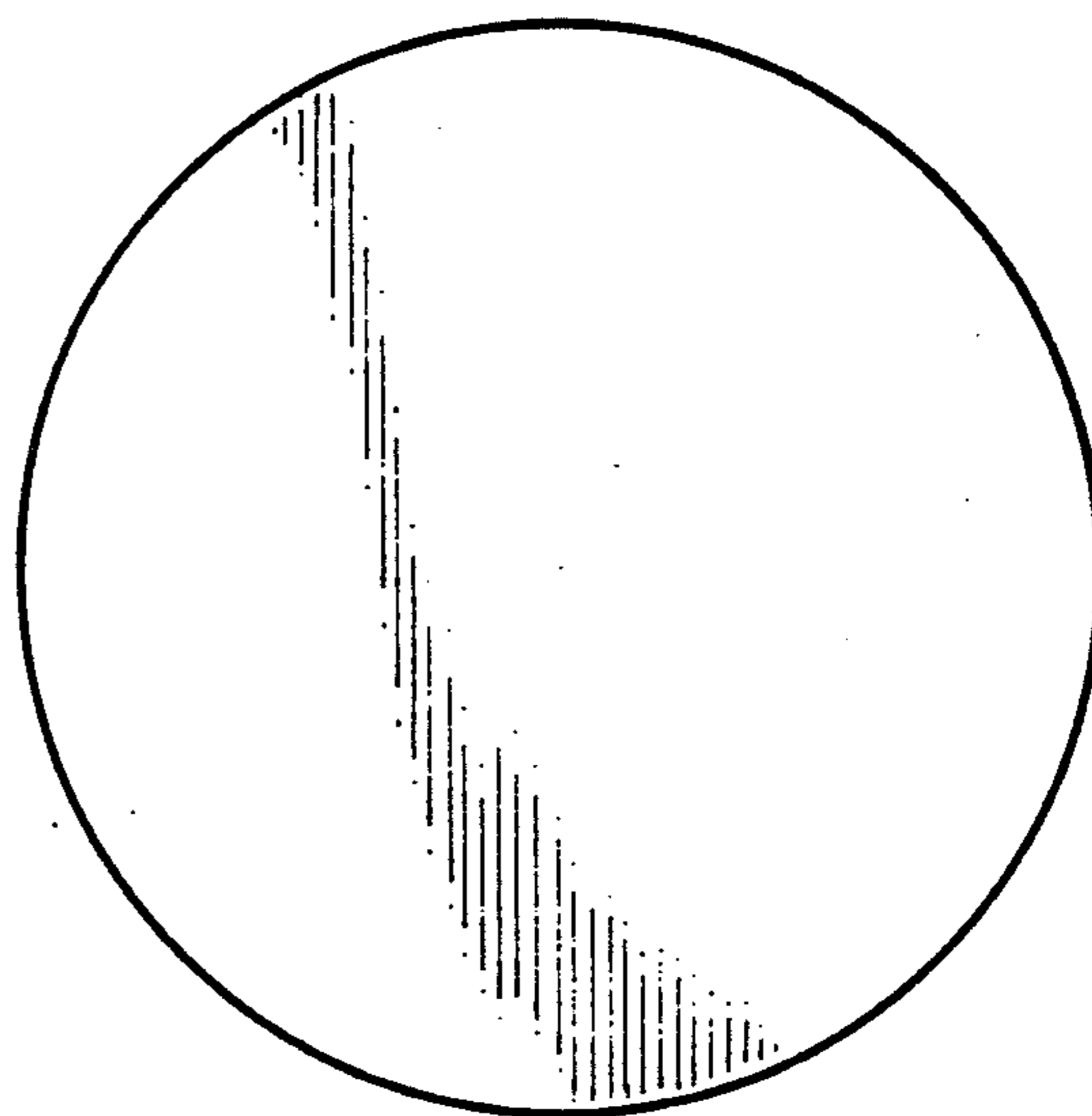

FIG. 6

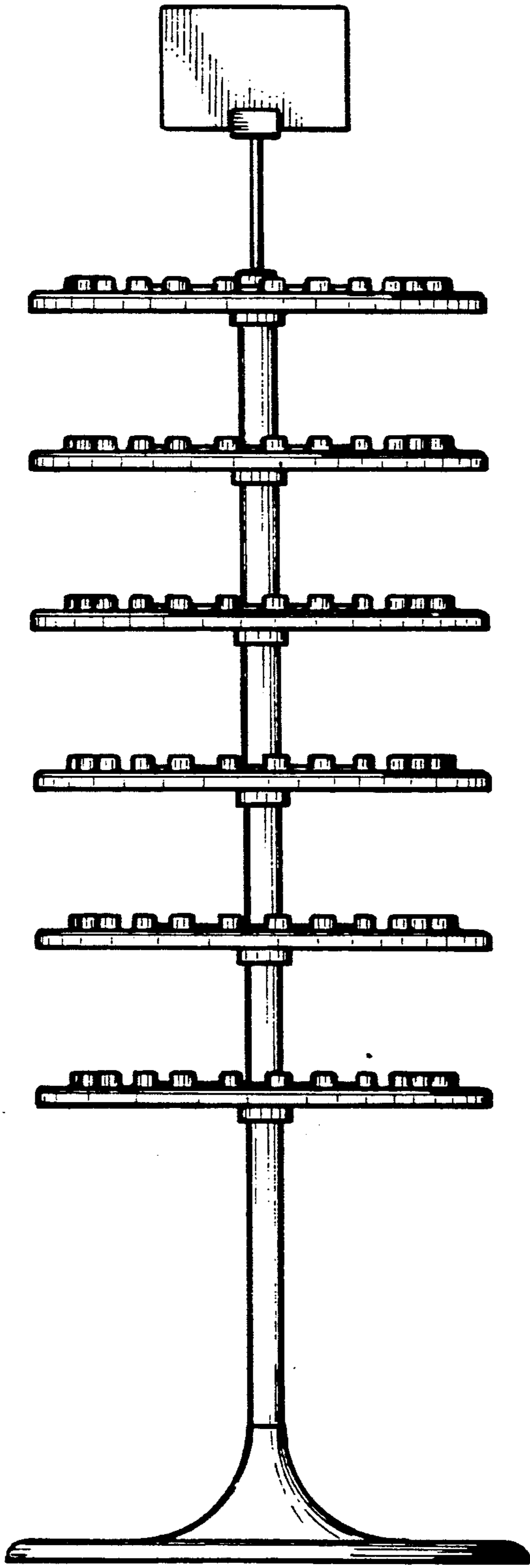

FIG. 7

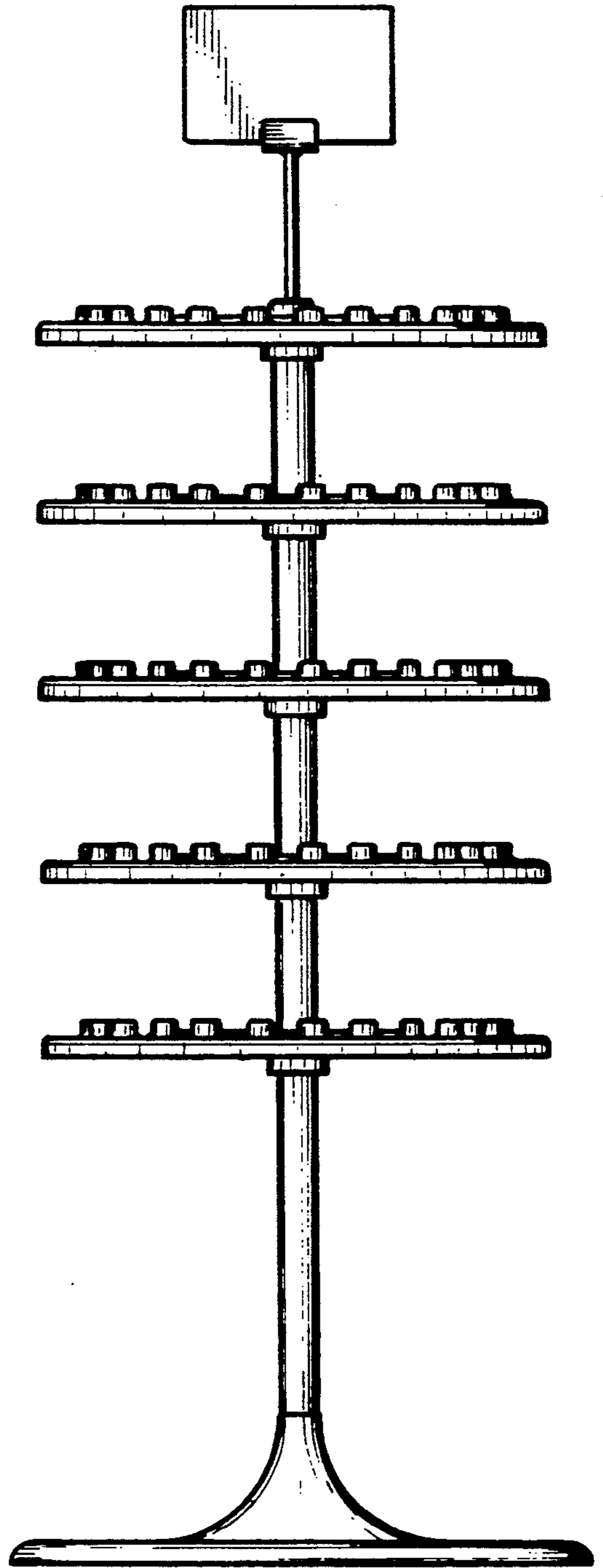

FIG. 8

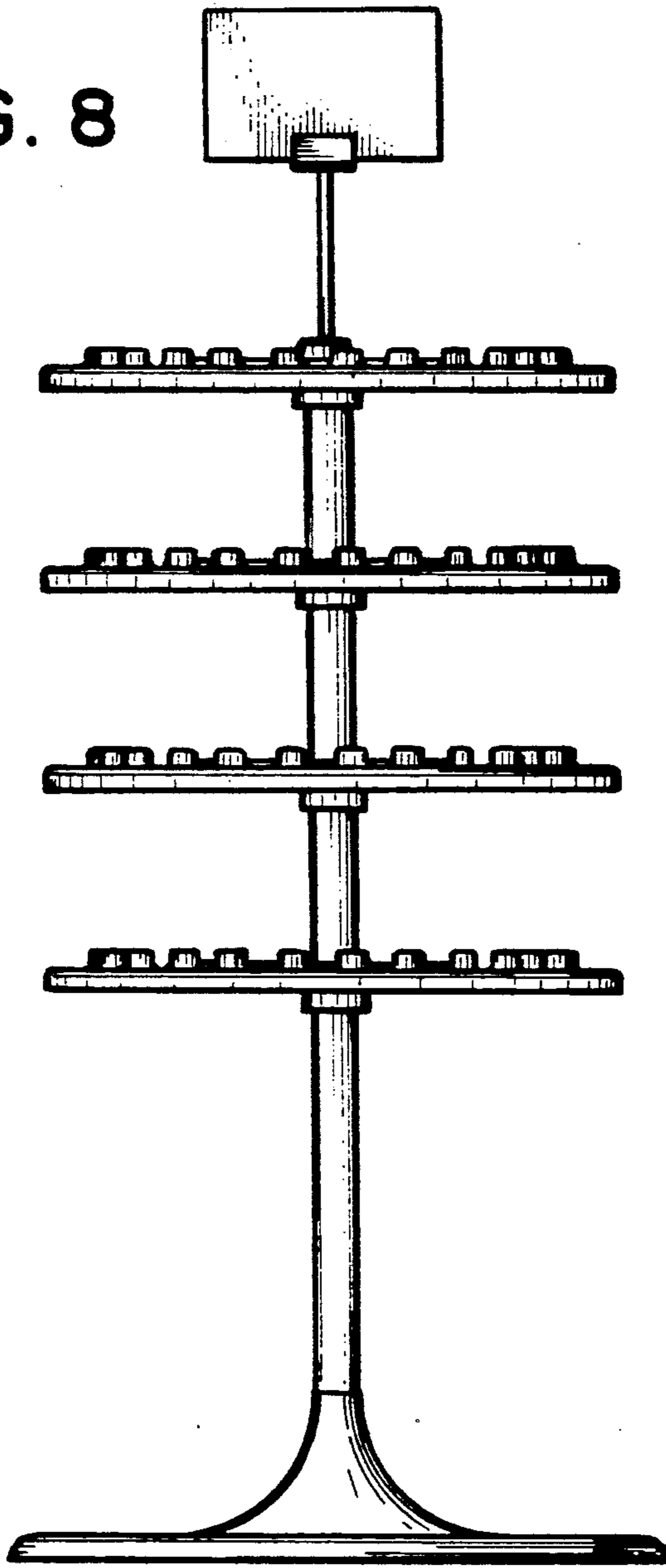

FIG. 16

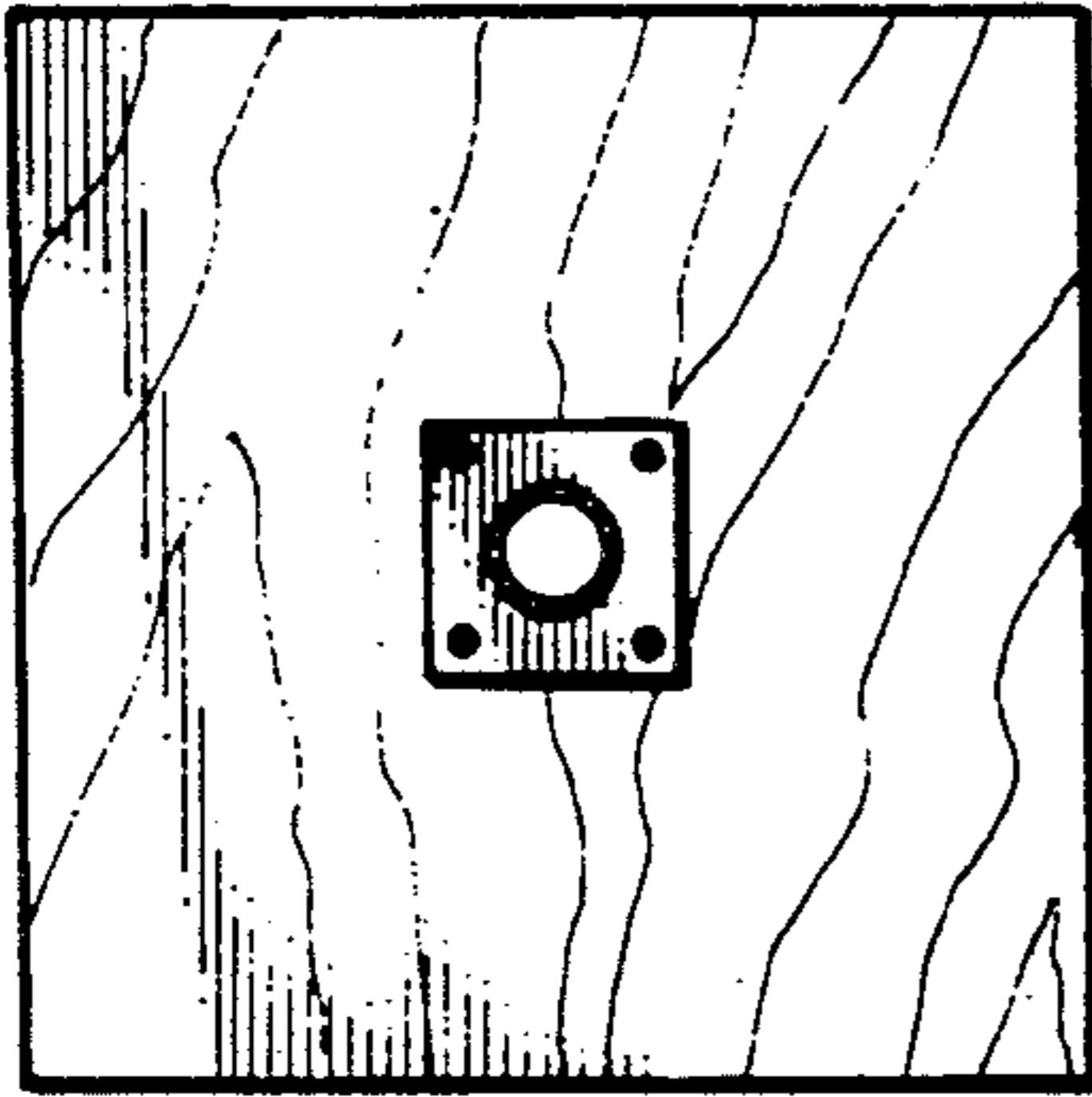

FIG. 9

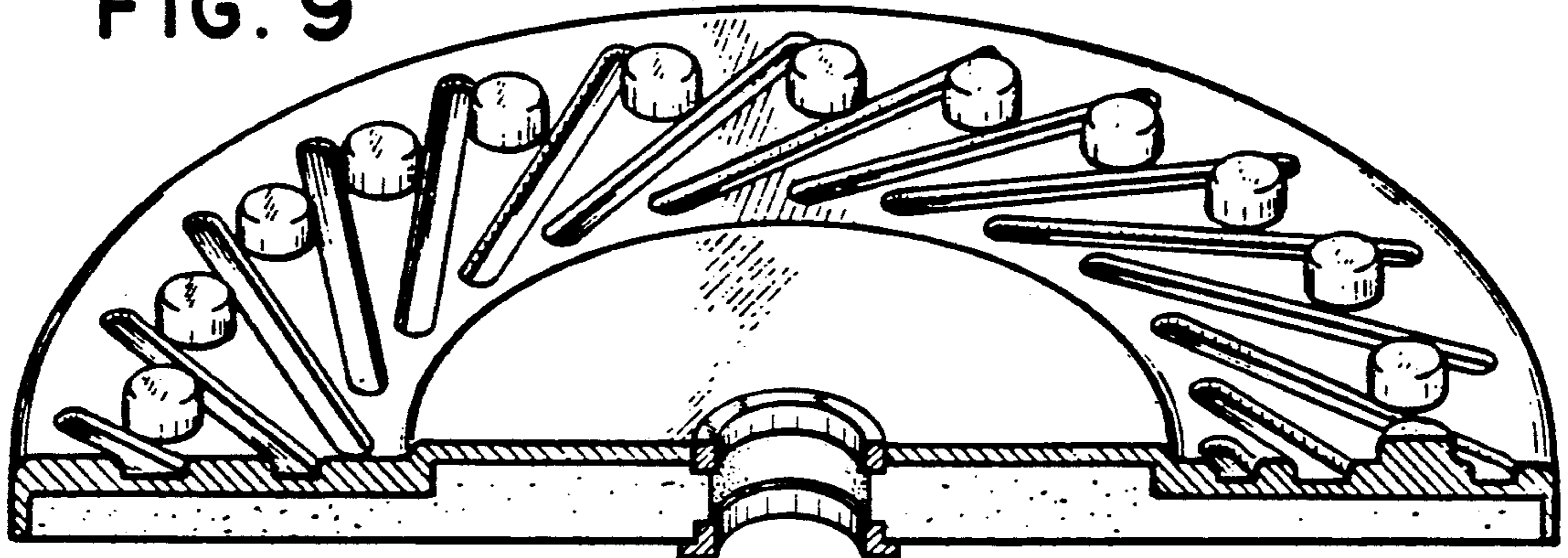

FIG. 10

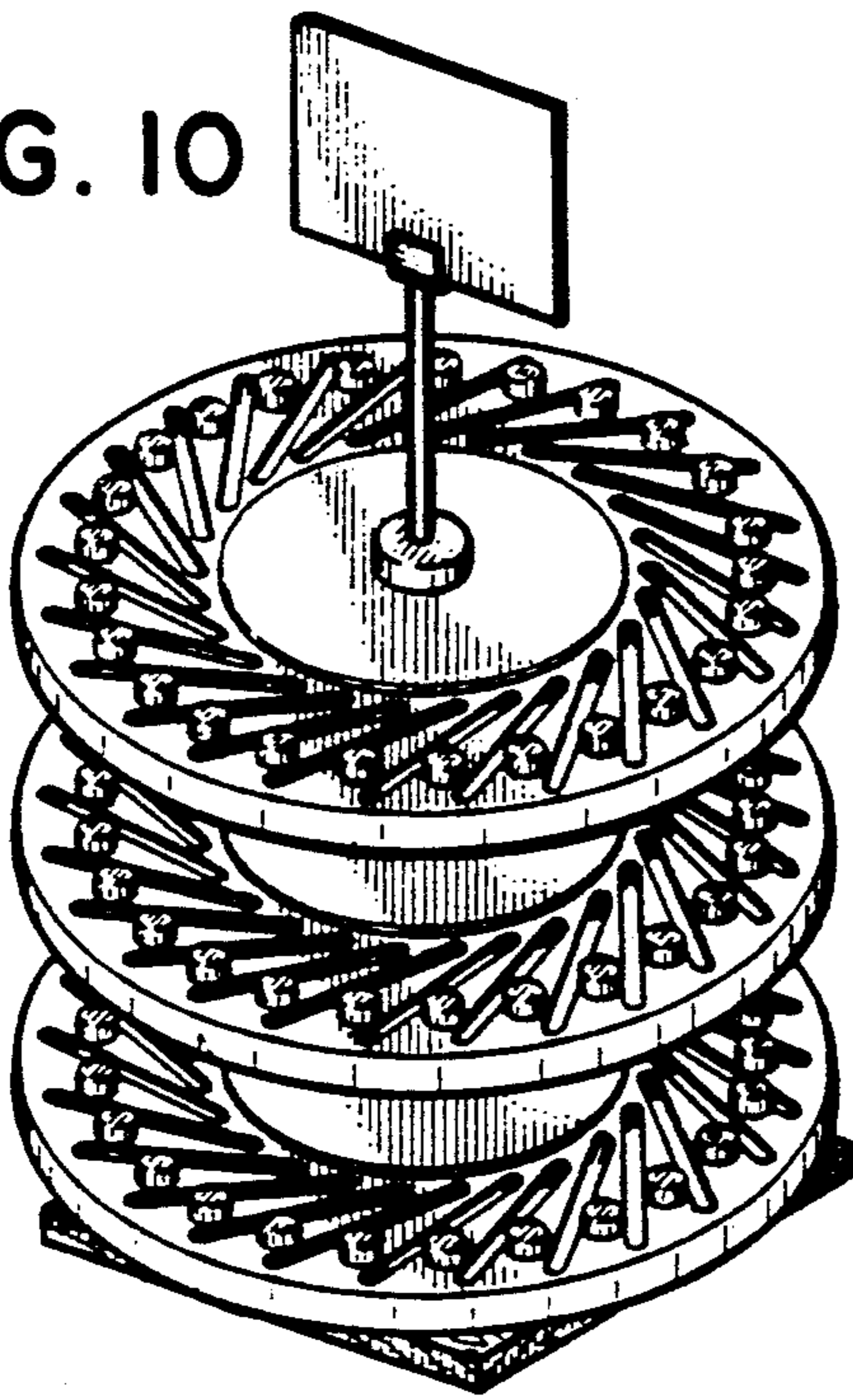

FIG. 11

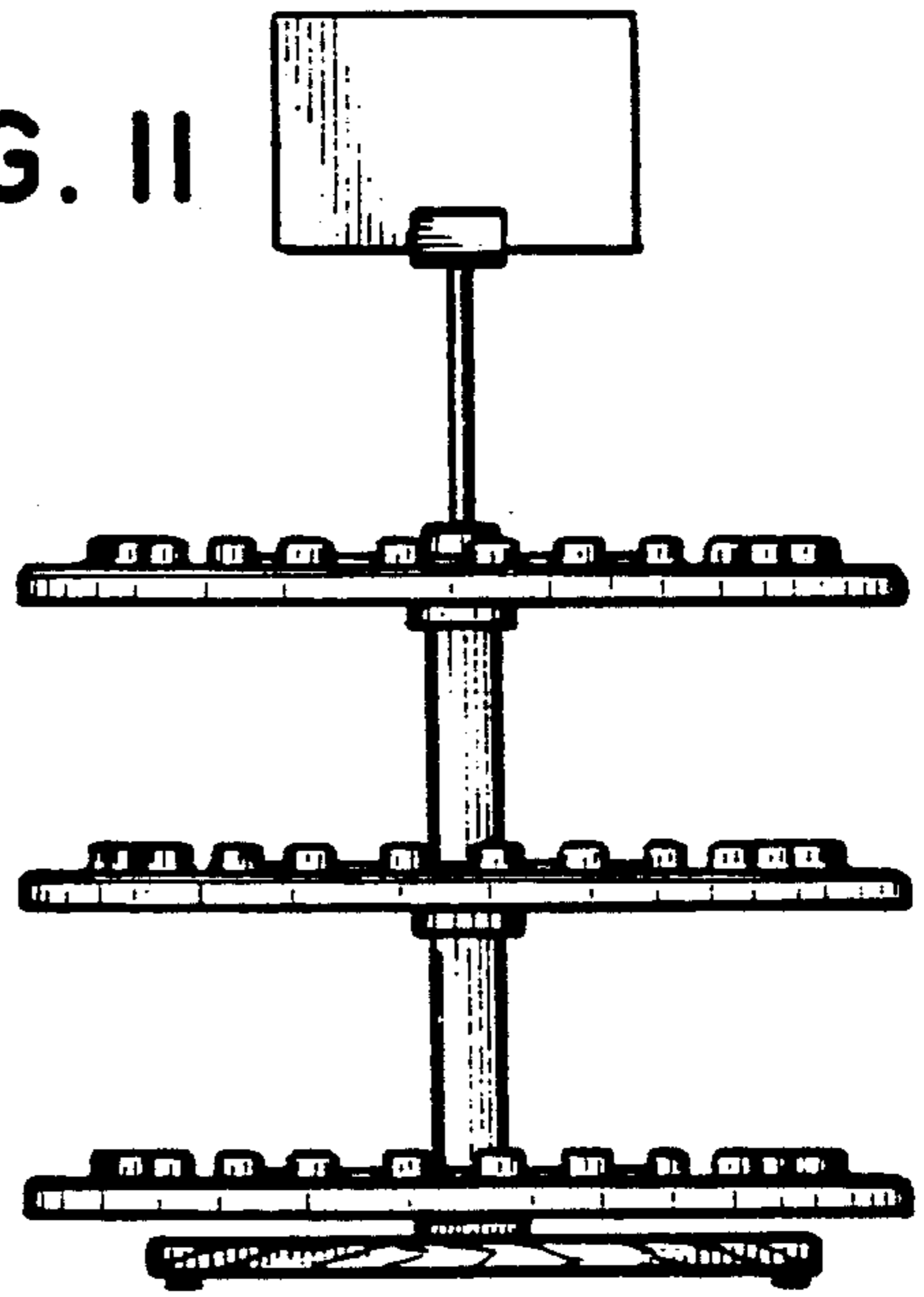

FIG. 12

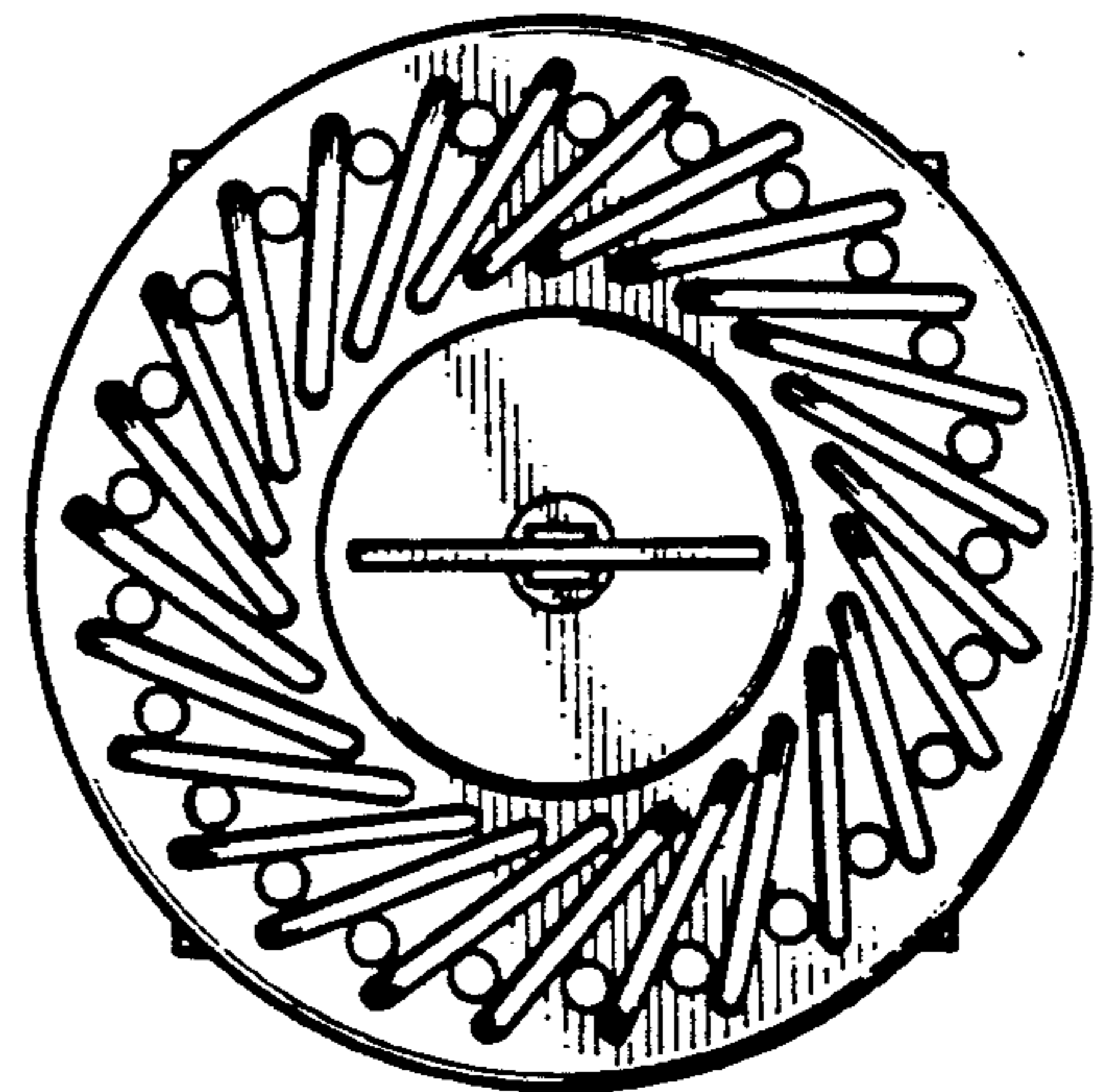

FIG. 14

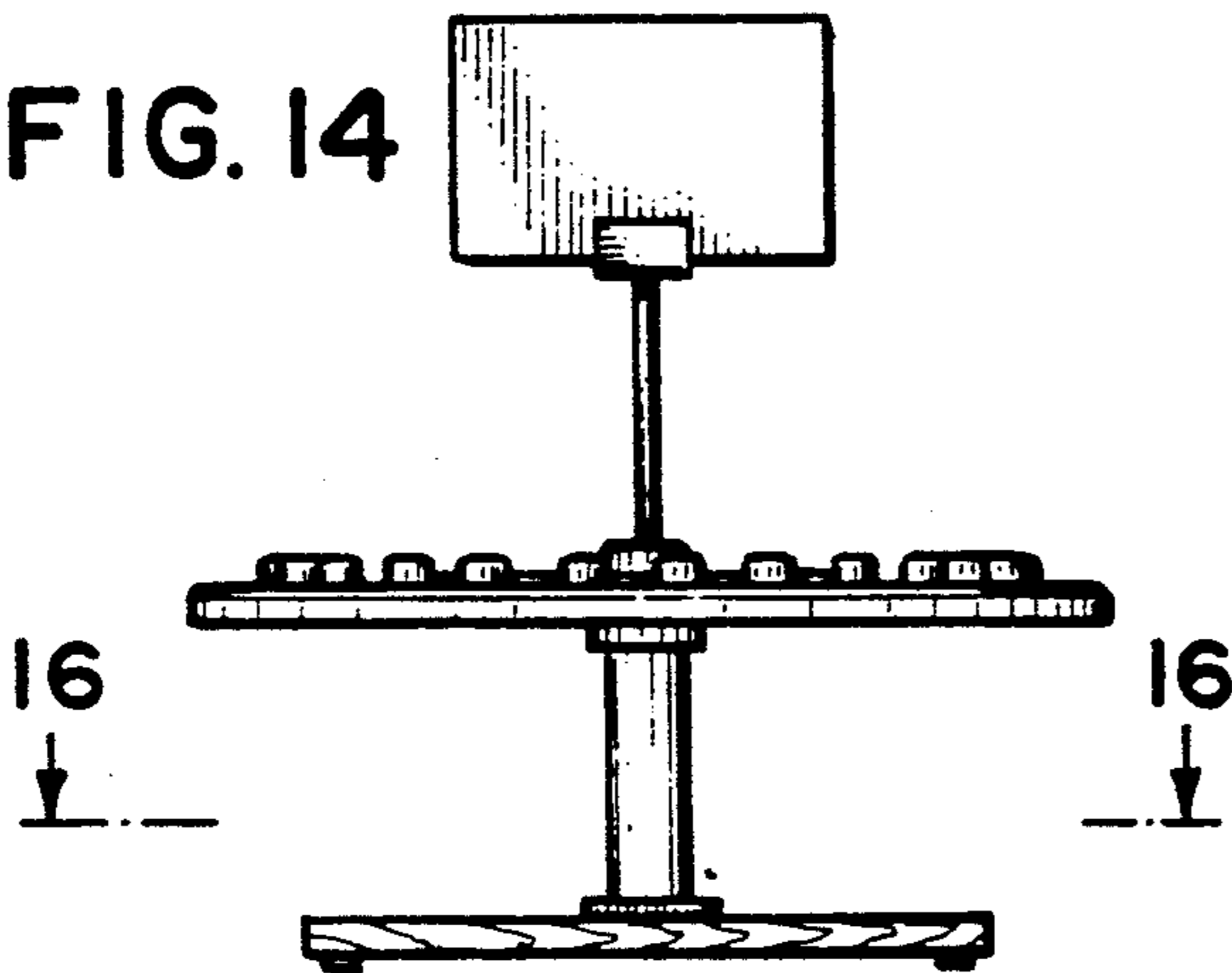

FIG. 13

FIG. 15

