



US00D328642S

# United States Patent [19]

[11] Patent Number: Des. 328,642

Say

[45] Date of Patent: \*\* Aug. 11, 1992

[54] COMBINED ASPIRATOR AND SOFT PACK

[76] Inventor: Sam L. Say, 1210 El Vago St., La Canada, Calif. 91011

[\*\*] Term: 14 Years

[21] Appl. No.: 478,764

[22] Filed: Feb. 12, 1990

[52] U.S. Cl. .... D24/111; D3/32; D24/108

[58] Field of Search ..... D24/111; 422/26, 27; 206/484, 439, 438; 128/760; 383/42, 43; 604/314, 317, 319, 318, 321, 403; 190/100, 103, 109, 112, 111, 115; 150/106, 117; D3/32

[56] References Cited

### U.S. PATENT DOCUMENTS

- D. 245,372 8/1977 Kurtz et al. .
- D. 250,207 11/1978 Kurtz et al. .
- D. 262,657 1/1982 Ekbladh .
- D. 268,305 3/1983 Stark .
- D. 270,948 10/1983 Say .
- D. 281,120 10/1985 Rabinowitz .
- D. 302,728 8/1989 Herbst et al. .... D24/111
- D. 305,798 1/1990 Say .
- 3,363,626 1/1968 Bidwell et al. .
- 3,782,384 1/1974 Timmermans .

- 3,915,189 10/1975 Holbrook et al. .
- 3,989,046 11/1976 Pannier, Jr. et al. .
- 4,275,731 6/1981 Nichols .
- 4,334,601 6/1982 Davis ..... 190/111 X
- 4,545,414 10/1985 Baum .
- 4,643,197 2/1987 Greene ..... 604/319 X
- 4,930,997 6/1990 Bennett ..... 604/319 X

Primary Examiner—Stella Reid  
Assistant Examiner—I. Simmons  
Attorney, Agent, or Firm—Christie, Parker & Hale

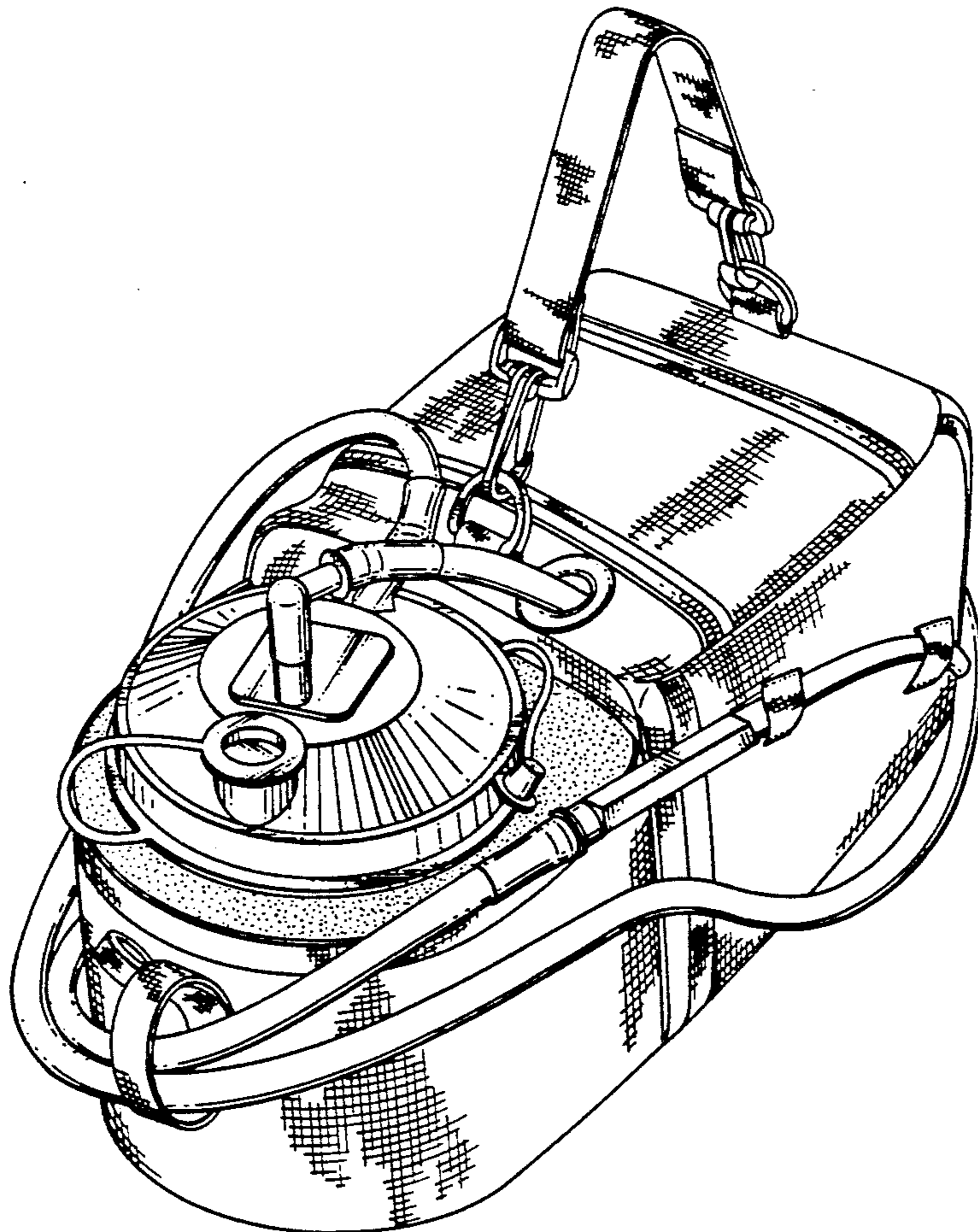
### [57] CLAIM

The ornamental design for a combined aspirator and soft pack, as shown and described.

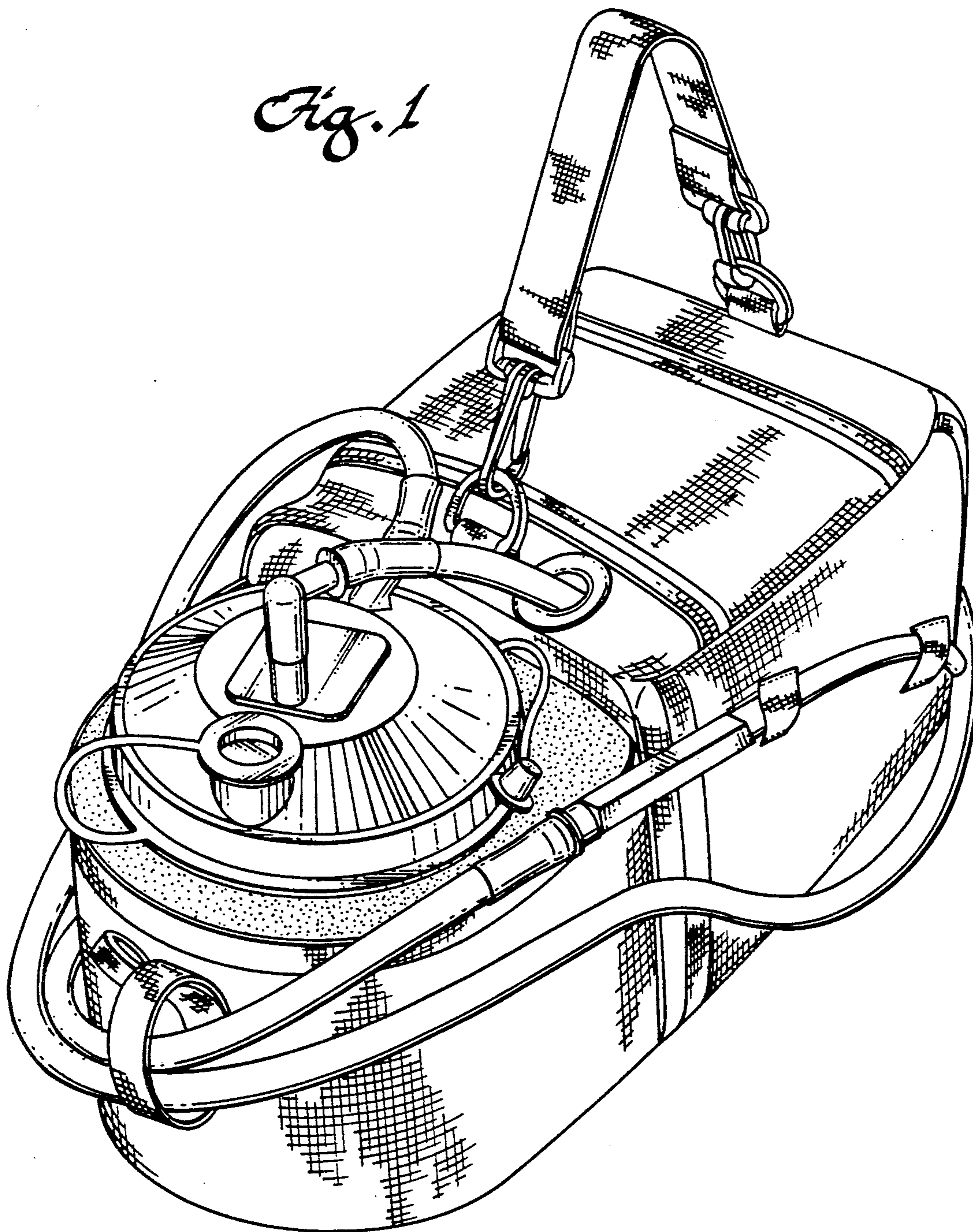
### DESCRIPTION

FIG. 1 is a front perspective view of a combined aspirator and soft pack, showing my new design;  
 FIG. 2 is a top plan view thereof;  
 FIG. 3 is a right side elevational view thereof;  
 FIG. 4 is a left side elevational view thereof;  
 FIG. 5 is a front elevational view thereof;  
 FIG. 6 is a rear elevational view thereof; and,  
 FIG. 7 is a bottom plan view thereof.

The cross-line pattern which is partially shown on the surface of the design for ease of illustration is intended to represent a conventional fabric.

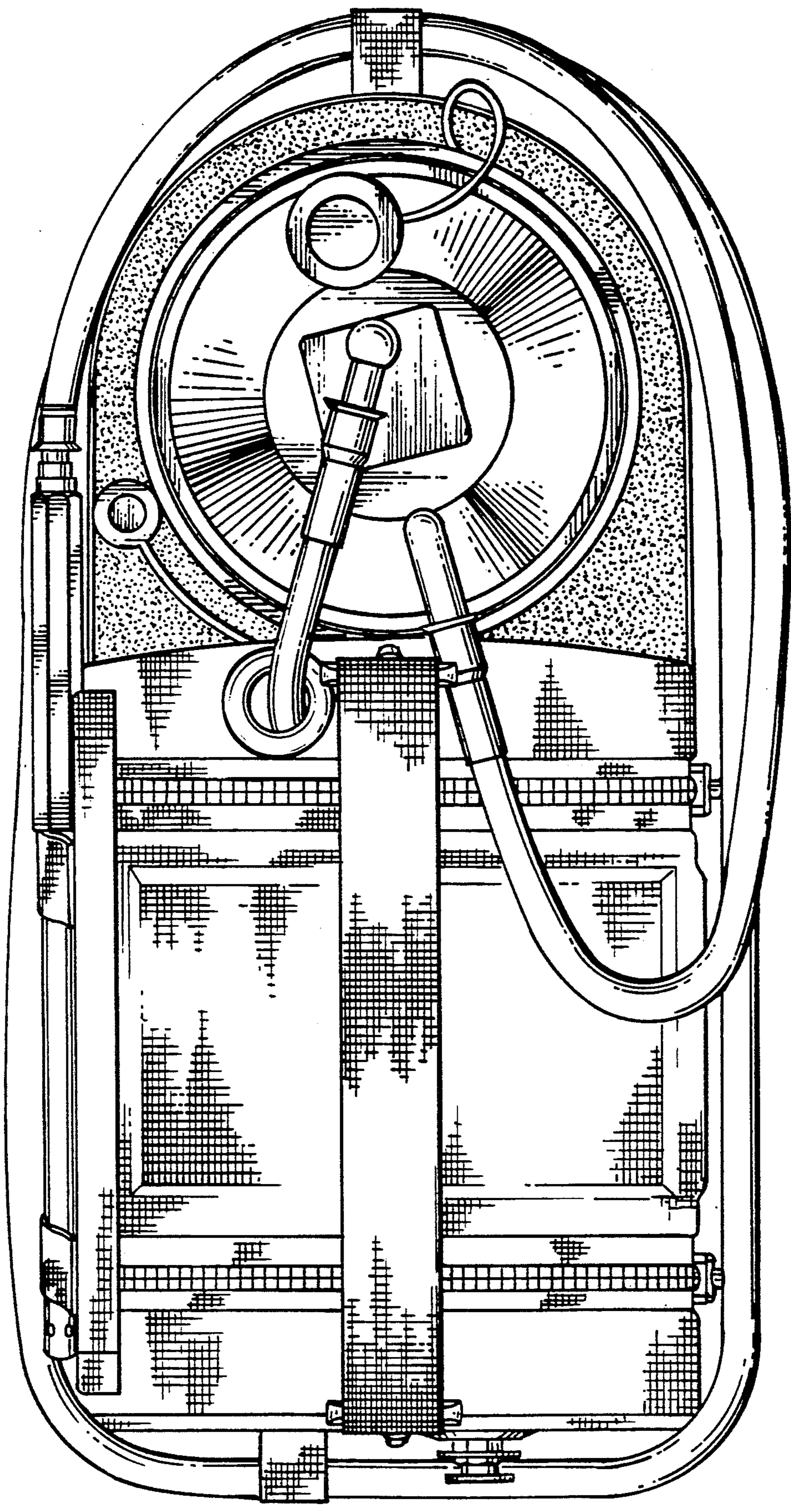


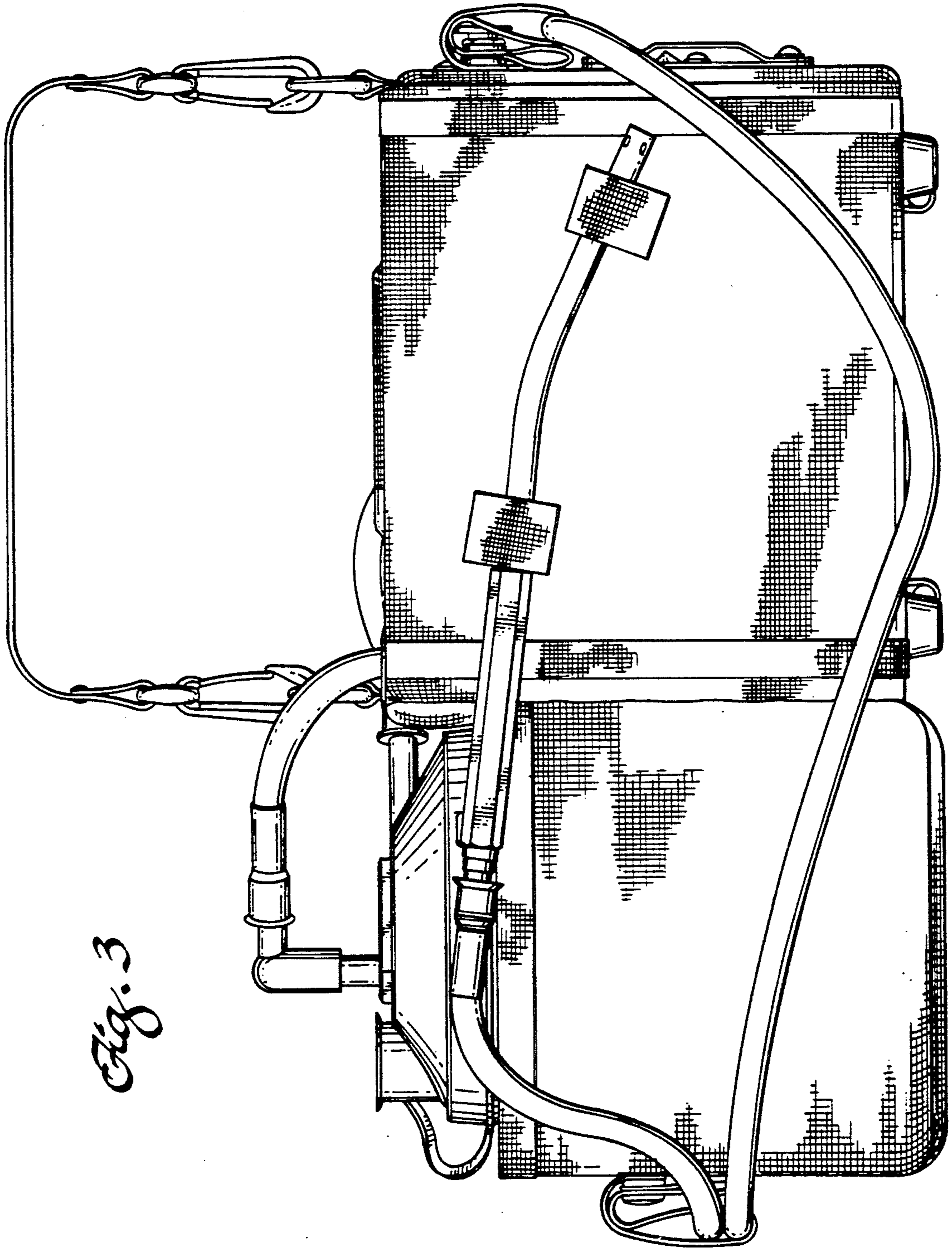
*Fig. 1*





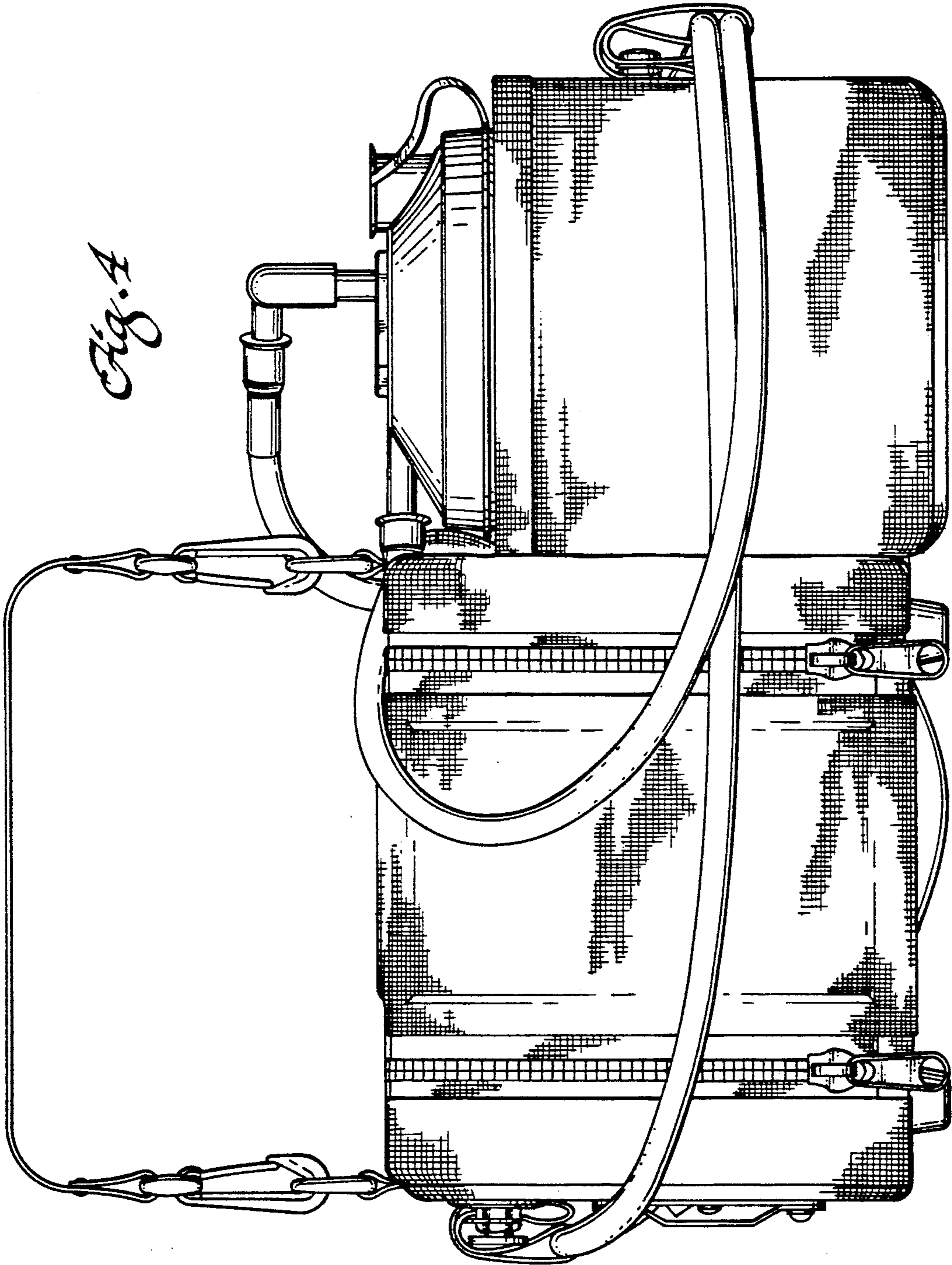
*Fig. 2*





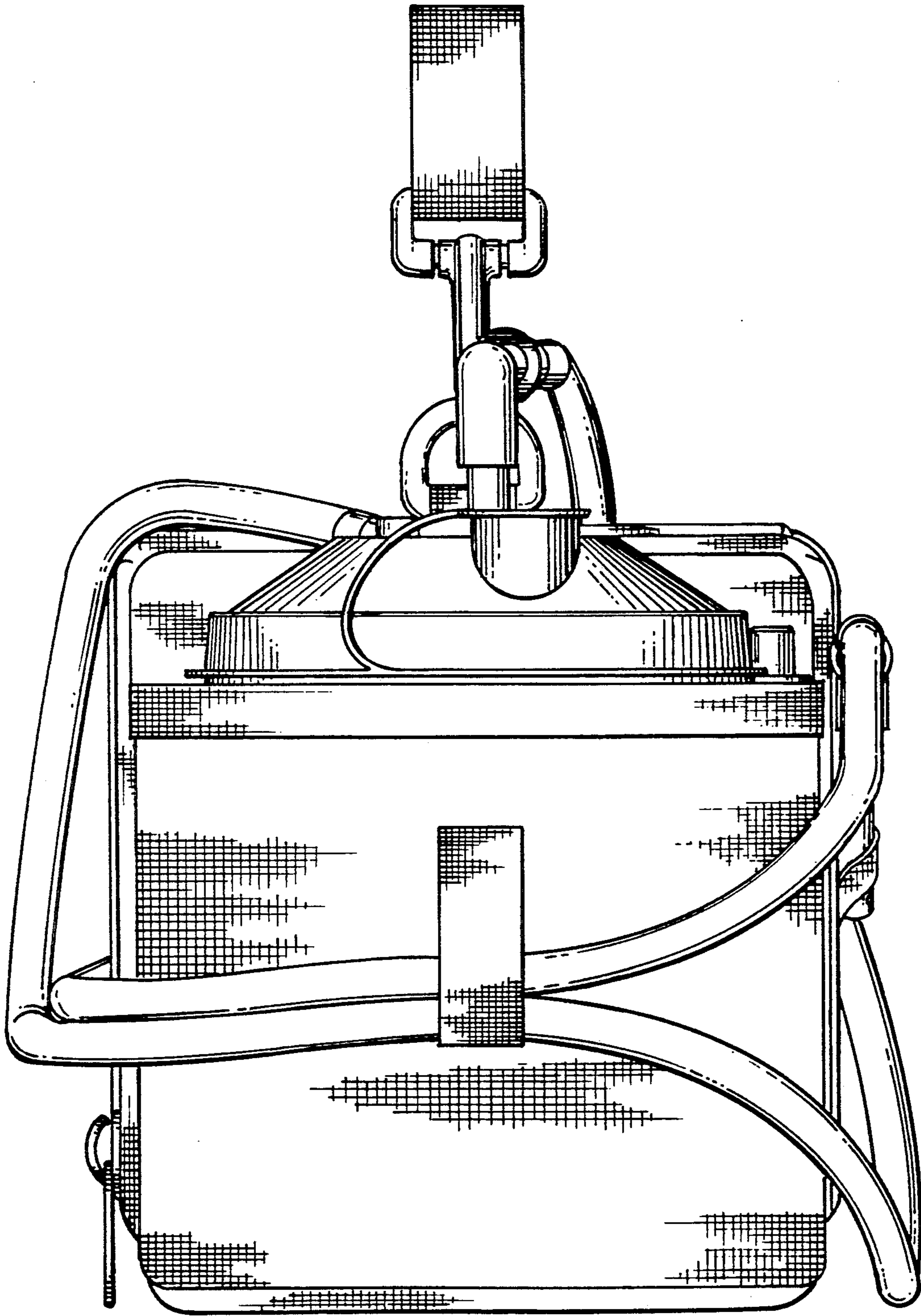
*Fig. 3*



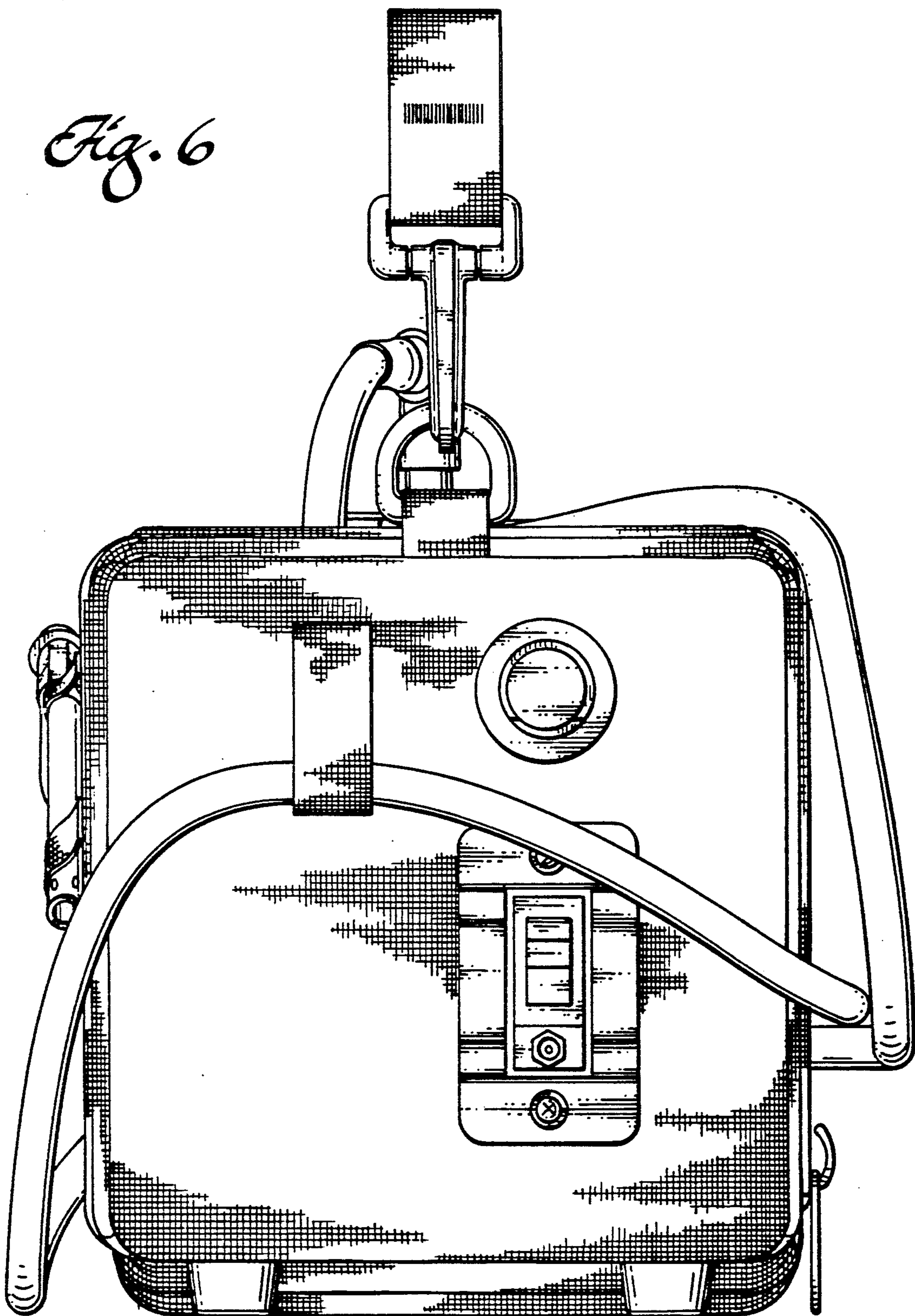


*Fig. A*

*Fig. 5*



*Fig. 6*





*Fig. 7*

