



US00D328550S

United States Patent [19]

[11] Patent Number: **Des. 328,550**

Mogil et al.

[45] Date of Patent: **** Aug. 11, 1992**

[54] PORTABLE COOLER CONTAINER

[75] Inventors: **Lorne S. Mogil; Melvin S. Mogil**, both of Toronto; **Roland J. Amber**, Richmond Hill, all of Canada

[73] Assignee: **California Innovations Inc.**, Ontario, Canada

[**] Term: **14 Years**

[21] Appl. No.: **561,658**

[22] Filed: **Aug. 2, 1990**

[52] U.S. Cl. **D7/605; D3/30.1; D3/76**

[58] Field of Search **D7/605-608; D3/30.1, 42, 52, 71, 76-79; 62/457.1, 457.7; 224/148; 383/110, 113**

[56] References Cited

U.S. PATENT DOCUMENTS

D. 284,715	7/1986	Jacober et al.	D7/605 X
D. 289,343	4/1987	Finger	D3/52 X
D. 291,150	8/1987	Beran	D3/36 X
D. 315,827	4/1991	King	D3/42 X
3,958,616	5/1976	Beverstock	D3/52 X
4,805,776	2/1989	Namgyal et al.	383/110 X

OTHER PUBLICATIONS

Portable cooler, 5 photographs, available prior to 1988 (submitted by applicant).

Primary Examiner—Terry A. Pfeffer

Attorney, Agent, or Firm—Jordan and Hamburg

[57] CLAIM

The ornamental design for a portable cooler container, as shown and described.

DESCRIPTION

FIG. 1 is a top, front, left side perspective view of a portable cooler container showing our new design;
 FIG. 2 is a top, rear, right side perspective view thereof;
 FIG. 3 is a top, front, left side perspective view thereof in an alternate position;
 FIG. 4 is a top, rear, right side perspective view of FIG. 3;
 FIG. 5 is a top, front, left side perspective view thereof in an alternate position;
 FIG. 6 is a top, rear, right side perspective view of FIG. 5;
 FIG. 7 is a top plan view thereof;
 FIG. 8 is a front elevational view thereof;
 FIG. 9 is a right side elevational view thereof;
 FIG. 10 is a left side elevational view thereof;
 FIG. 11 is a bottom plan view thereof;
 FIG. 12 is a rear elevational view thereof and of FIG. 3;
 FIG. 13 is a top plan view of FIG. 3;
 FIG. 14 is a front elevational view of FIGS. 3 and 5;
 FIG. 15 is a right elevational view of FIG. 3;
 FIG. 16 is a left side elevational view of FIG. 3;
 FIG. 17 is a top plan view of FIG. 5;
 FIG. 18 is a bottom plan view of FIG. 5;
 FIG. 19 is a left side elevational view of FIG. 5;
 FIG. 20 is a right side elevational view of FIG. 5; and,
 FIG. 21 is a rear elevational view of FIG. 5.

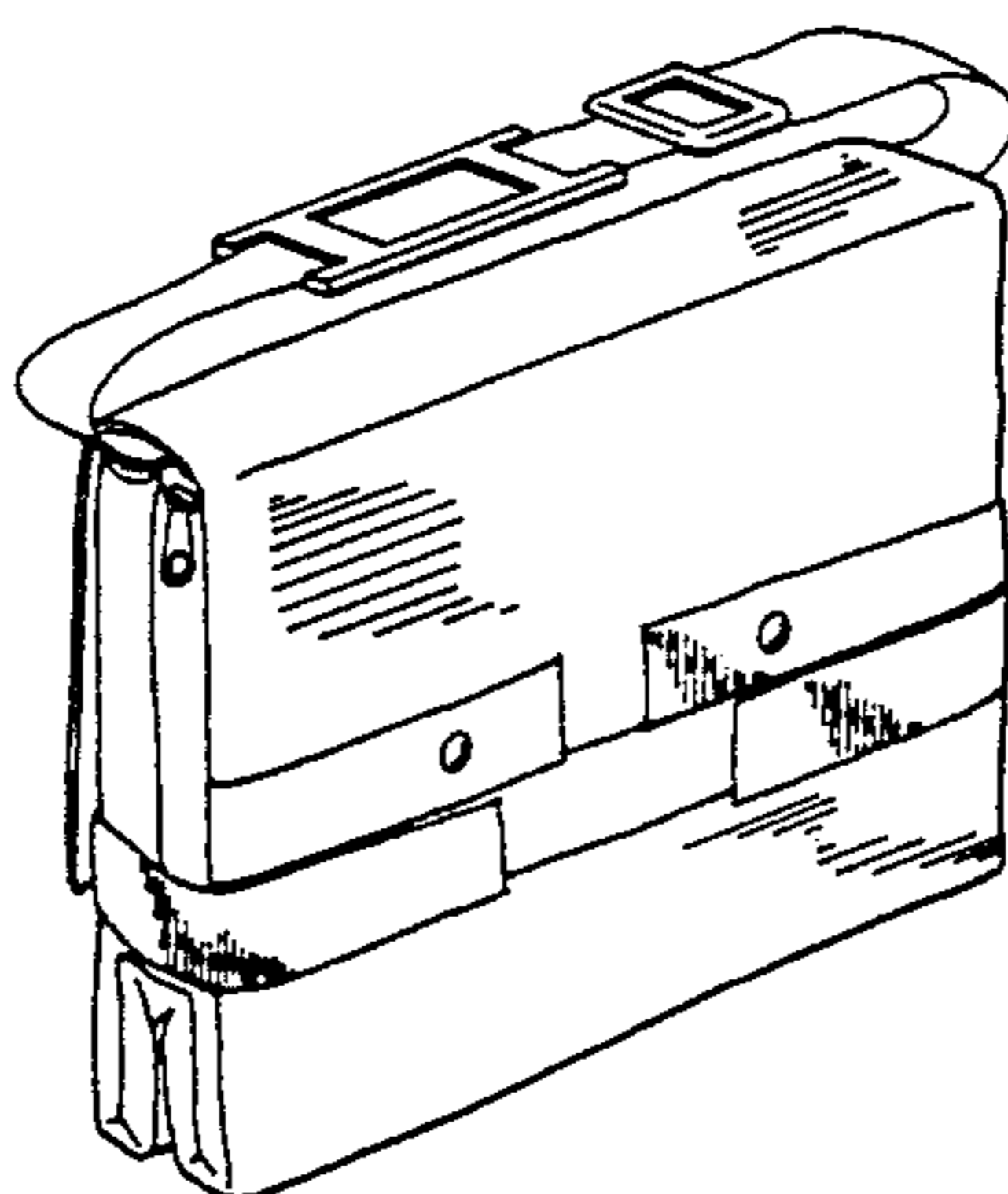
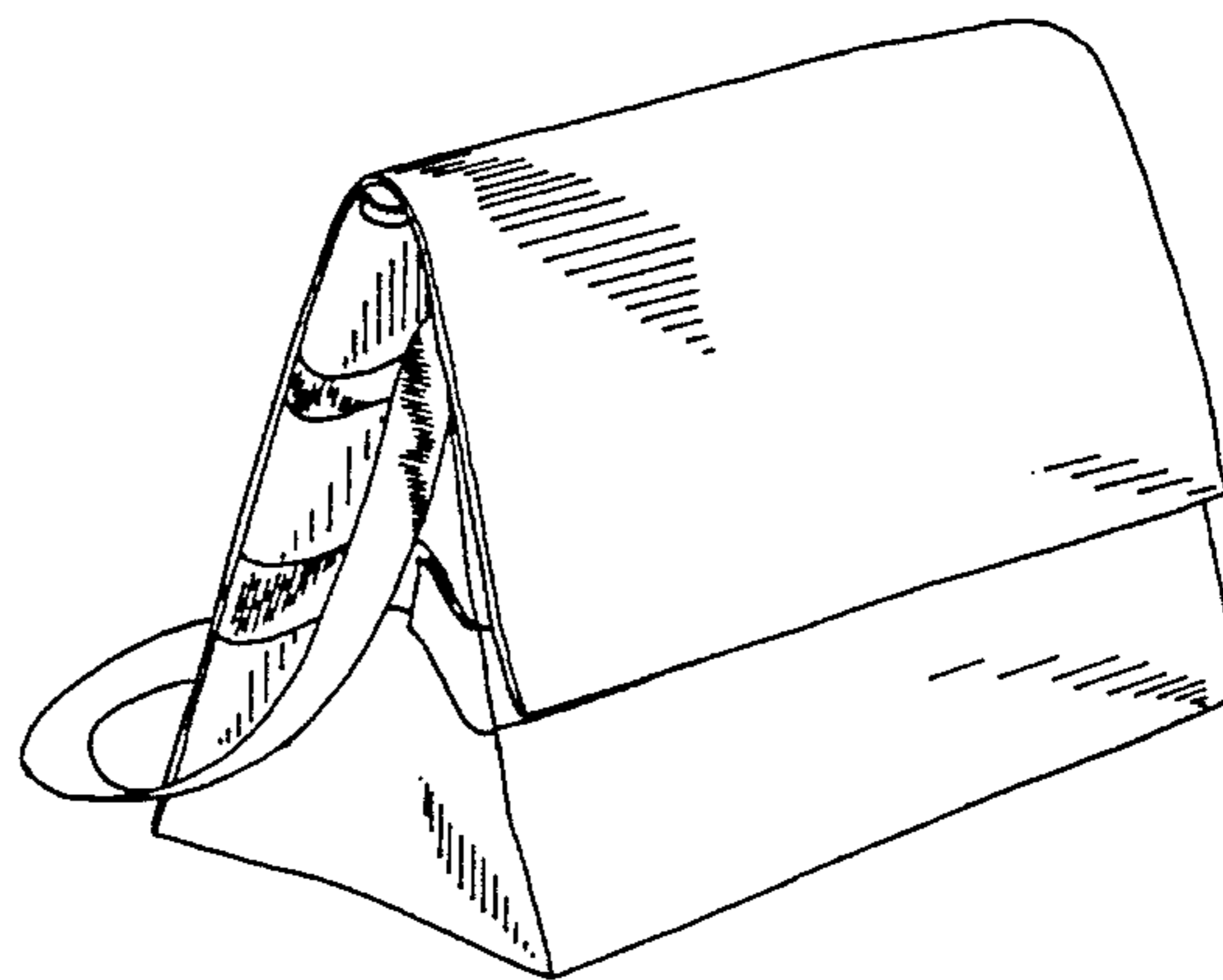
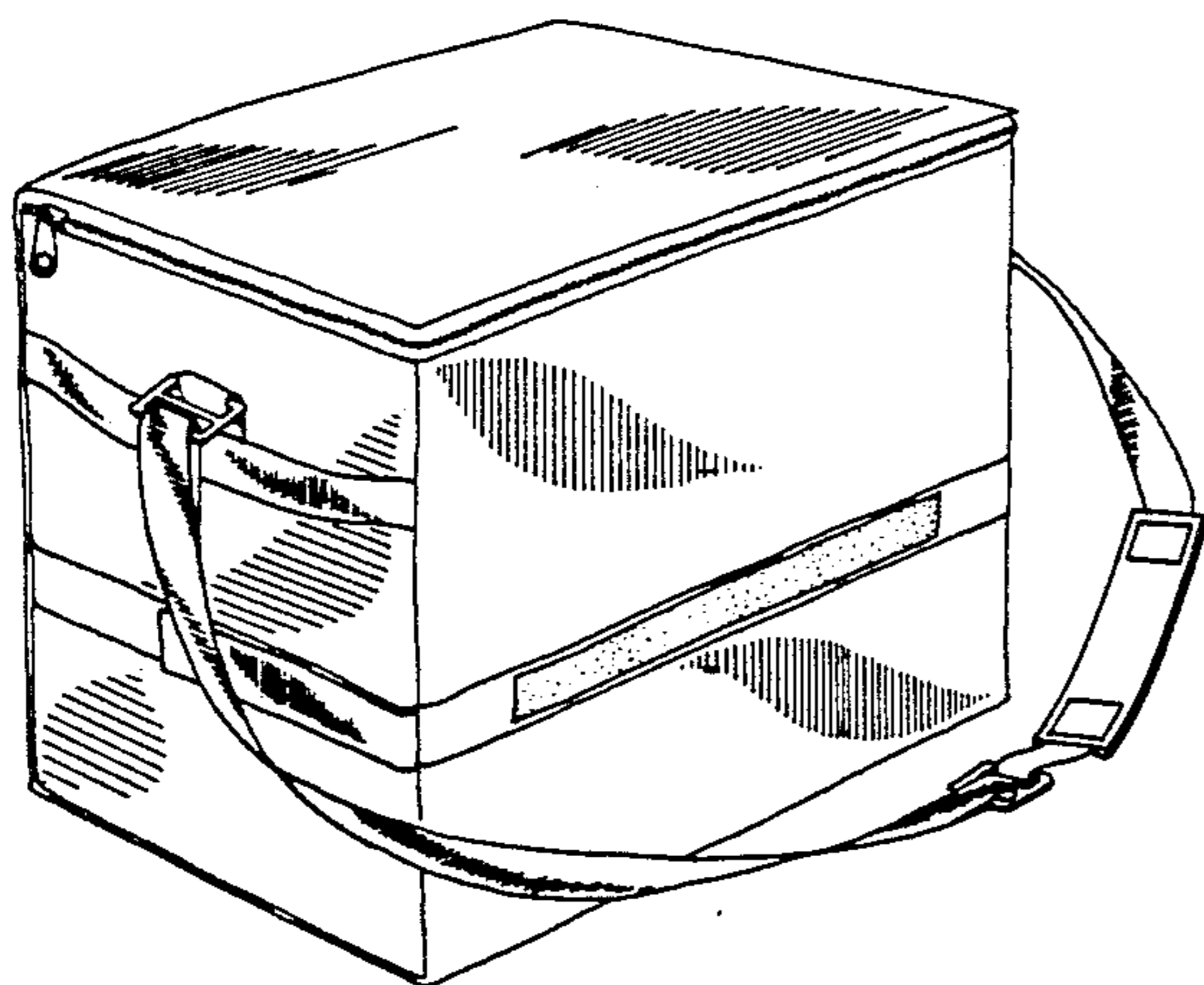

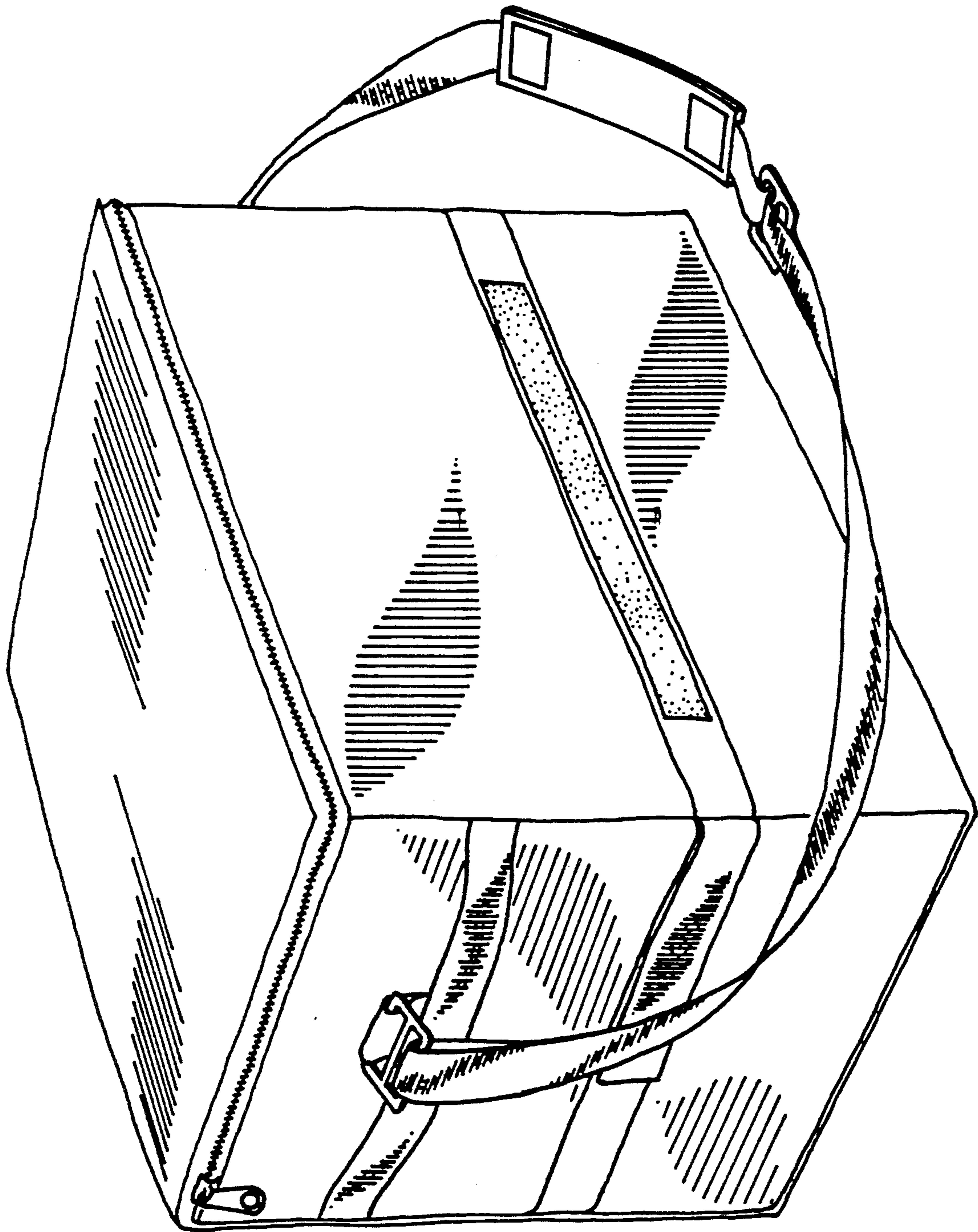

FIG.1

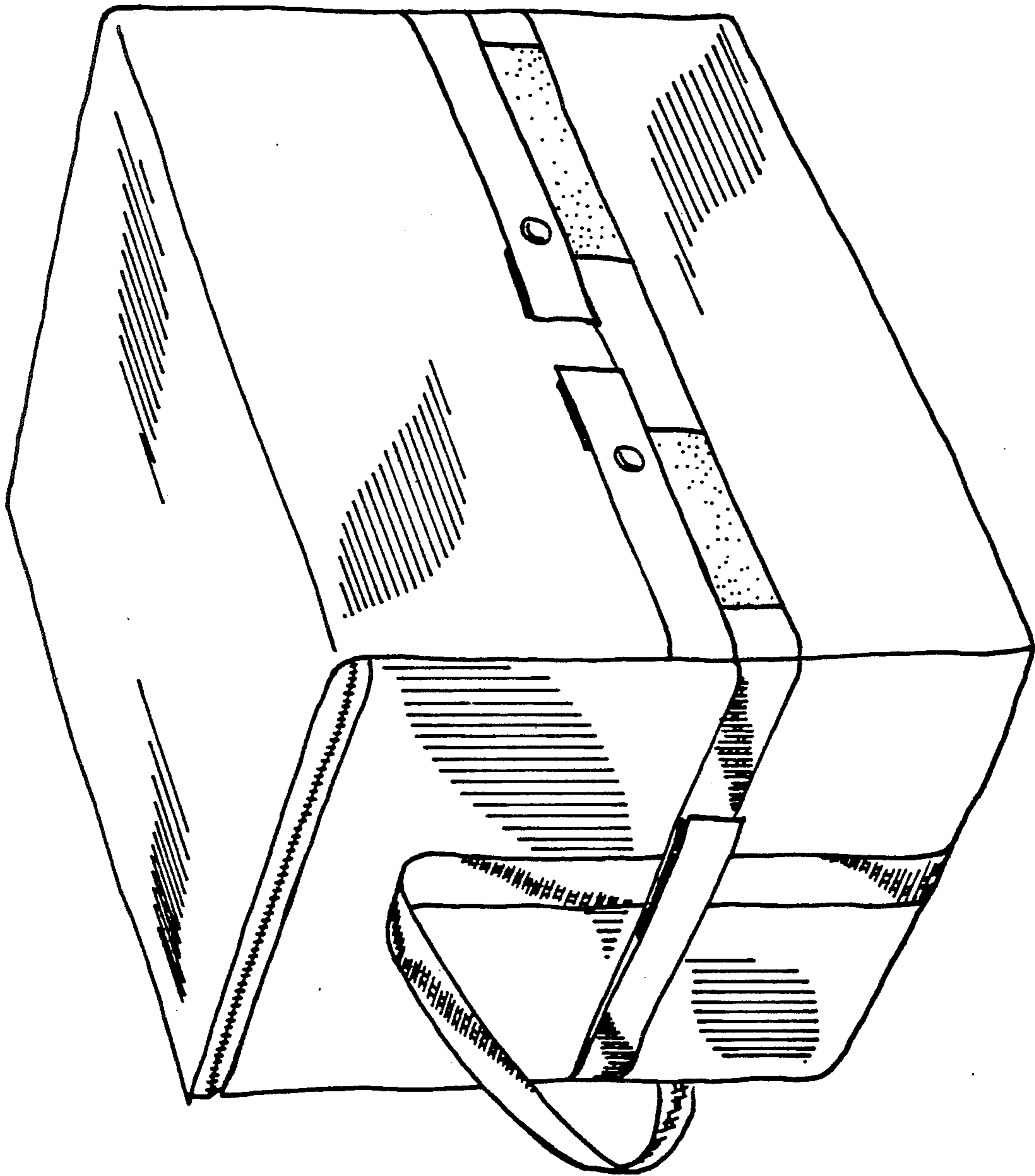

FIG.2

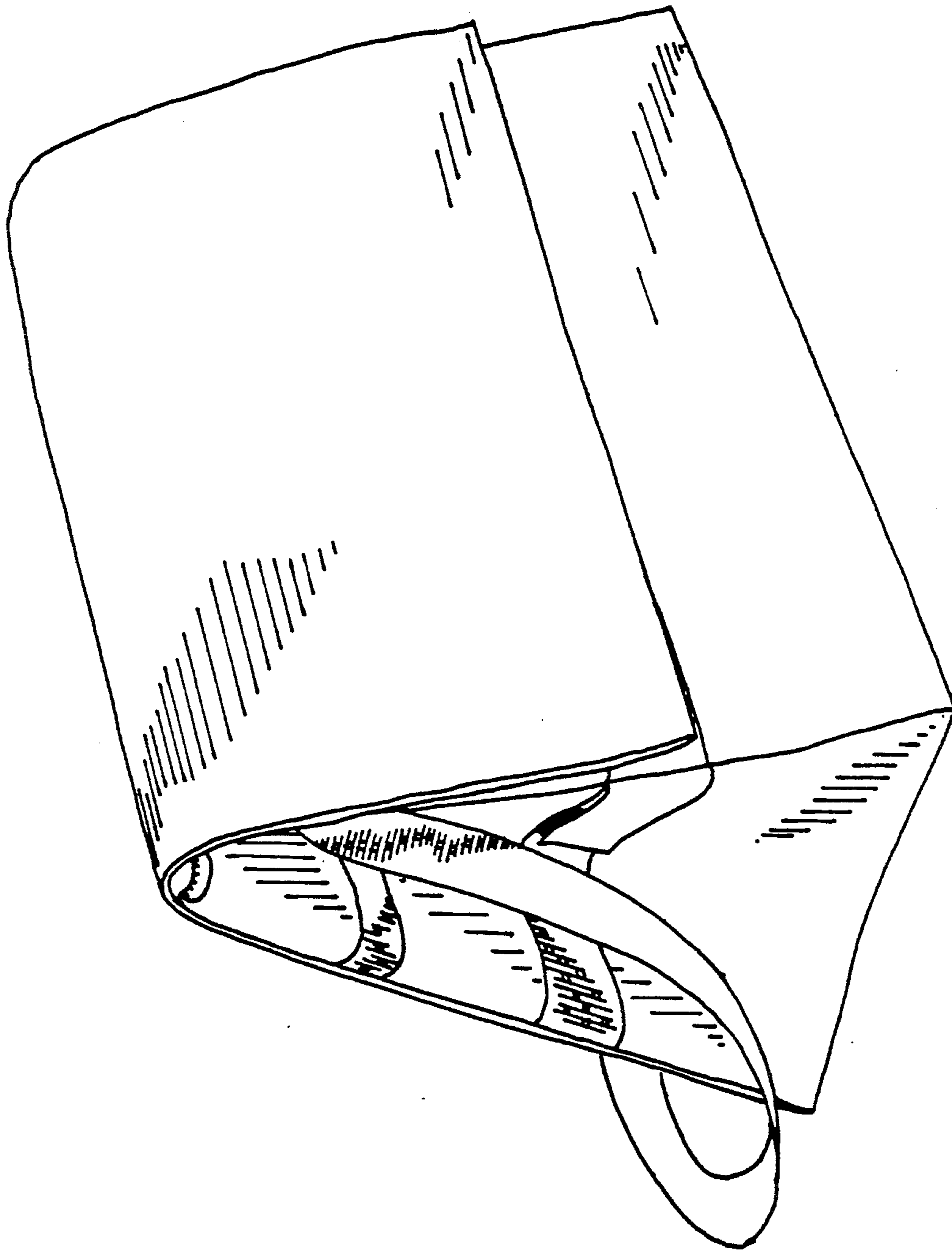

FIG.3

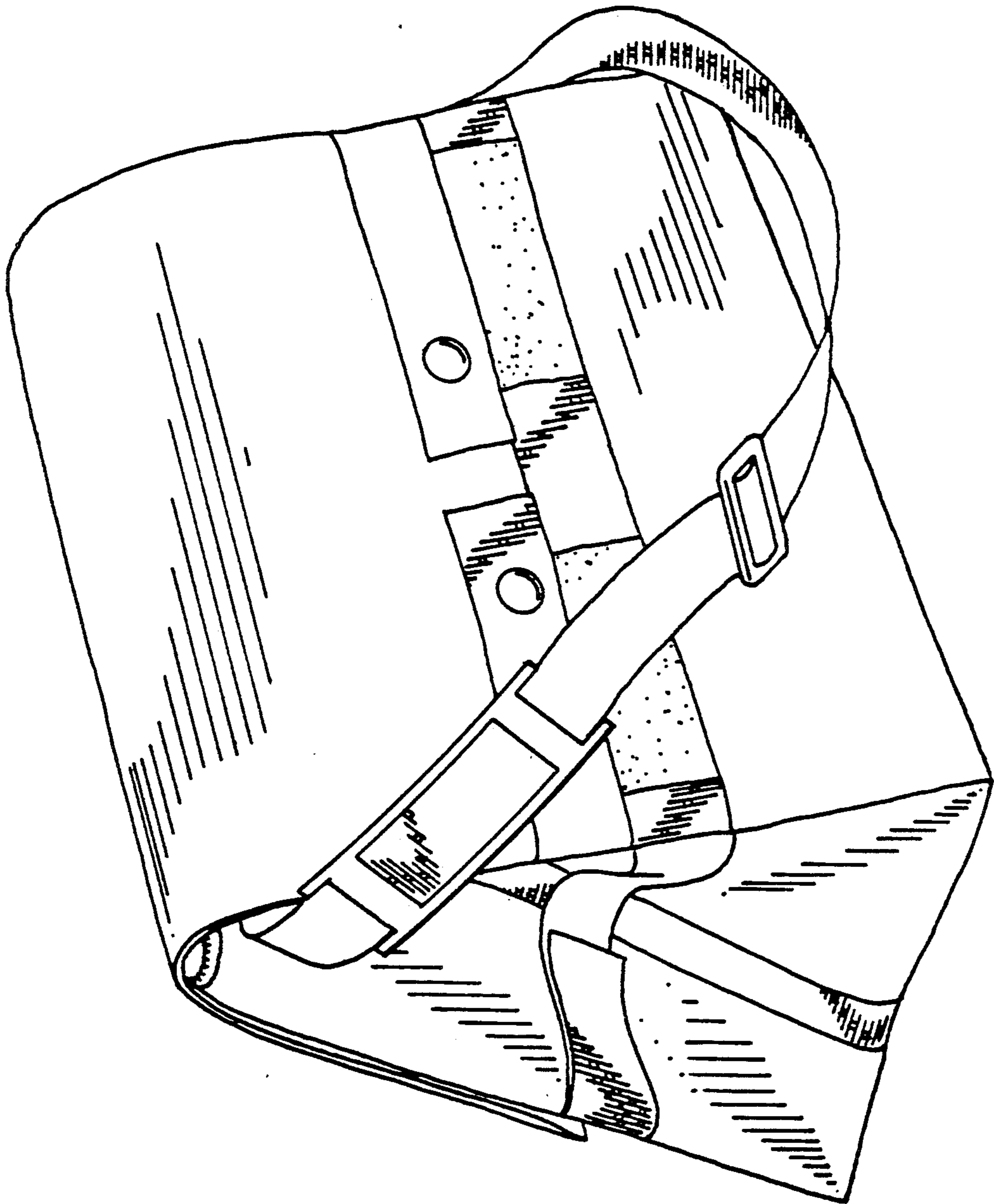

FIG.4

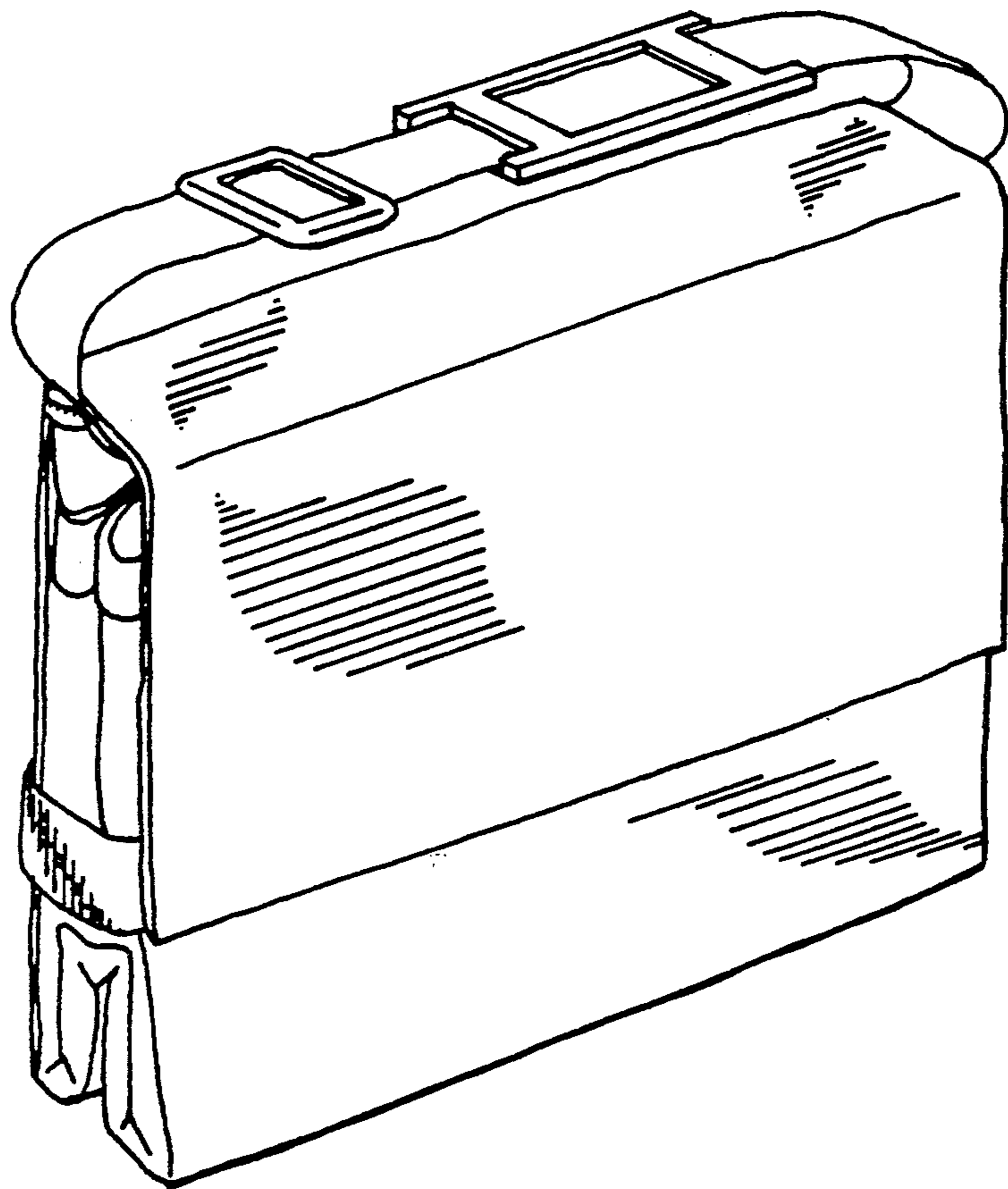

FIG. 5

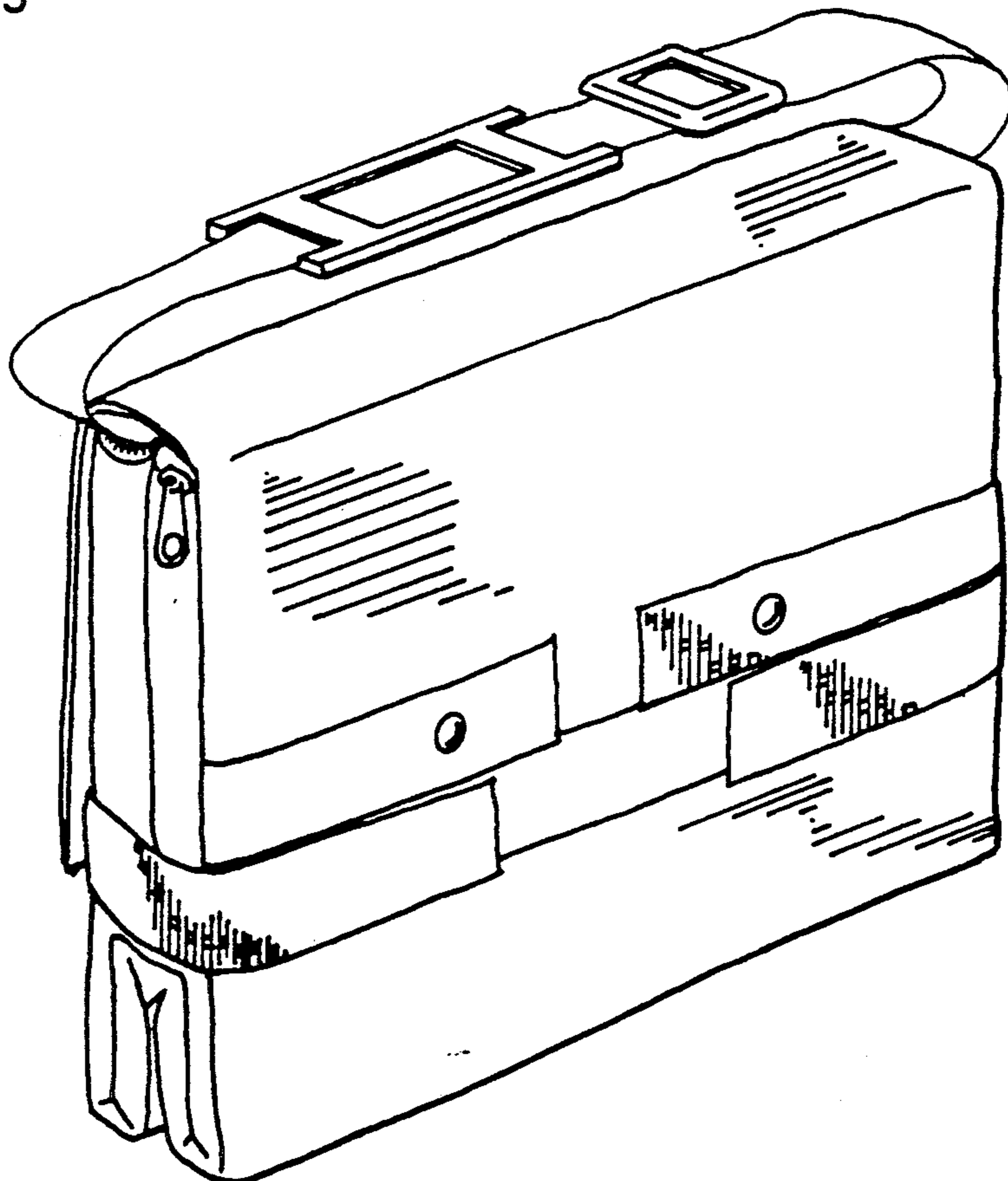

FIG. 6

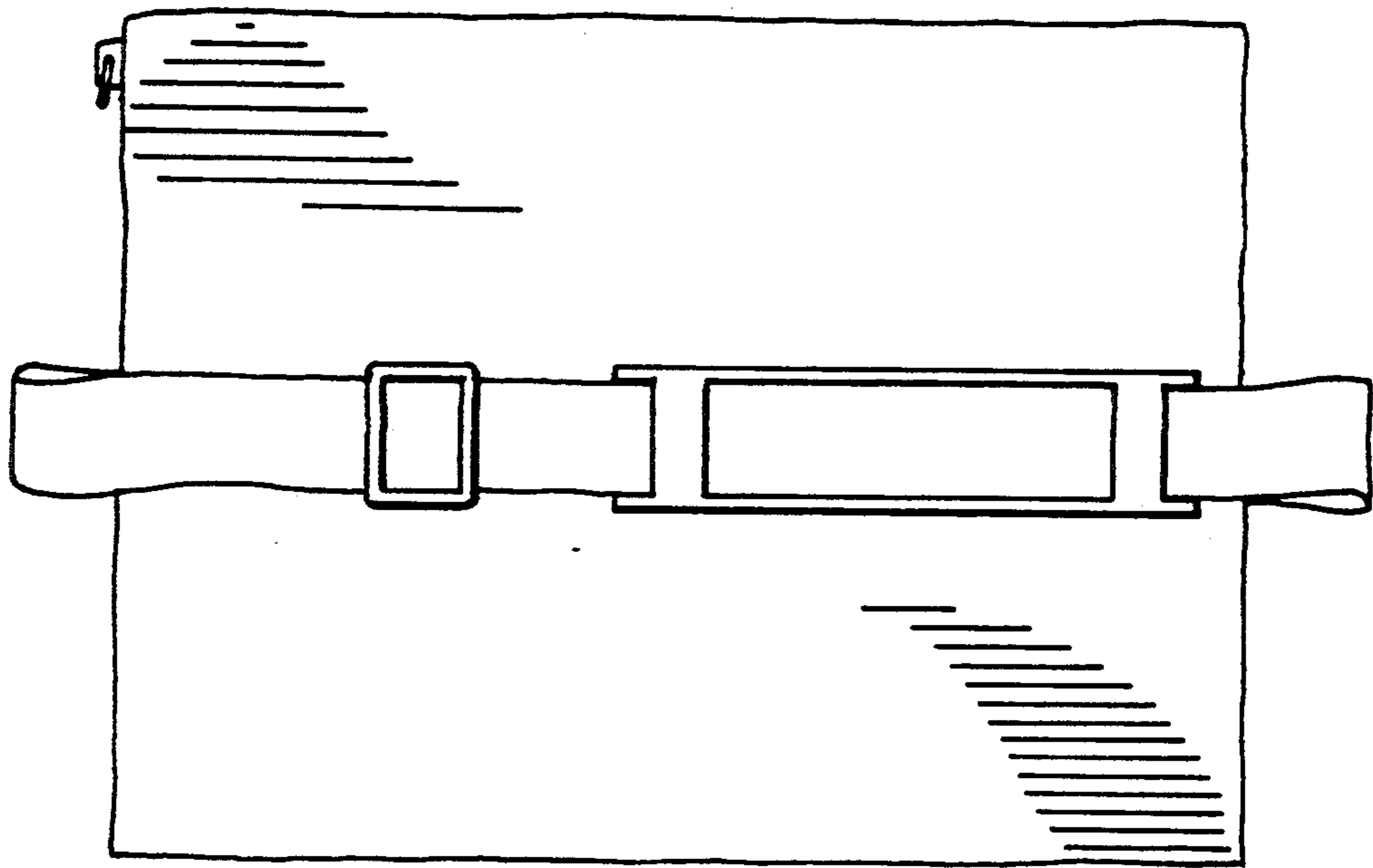

FIG. 7

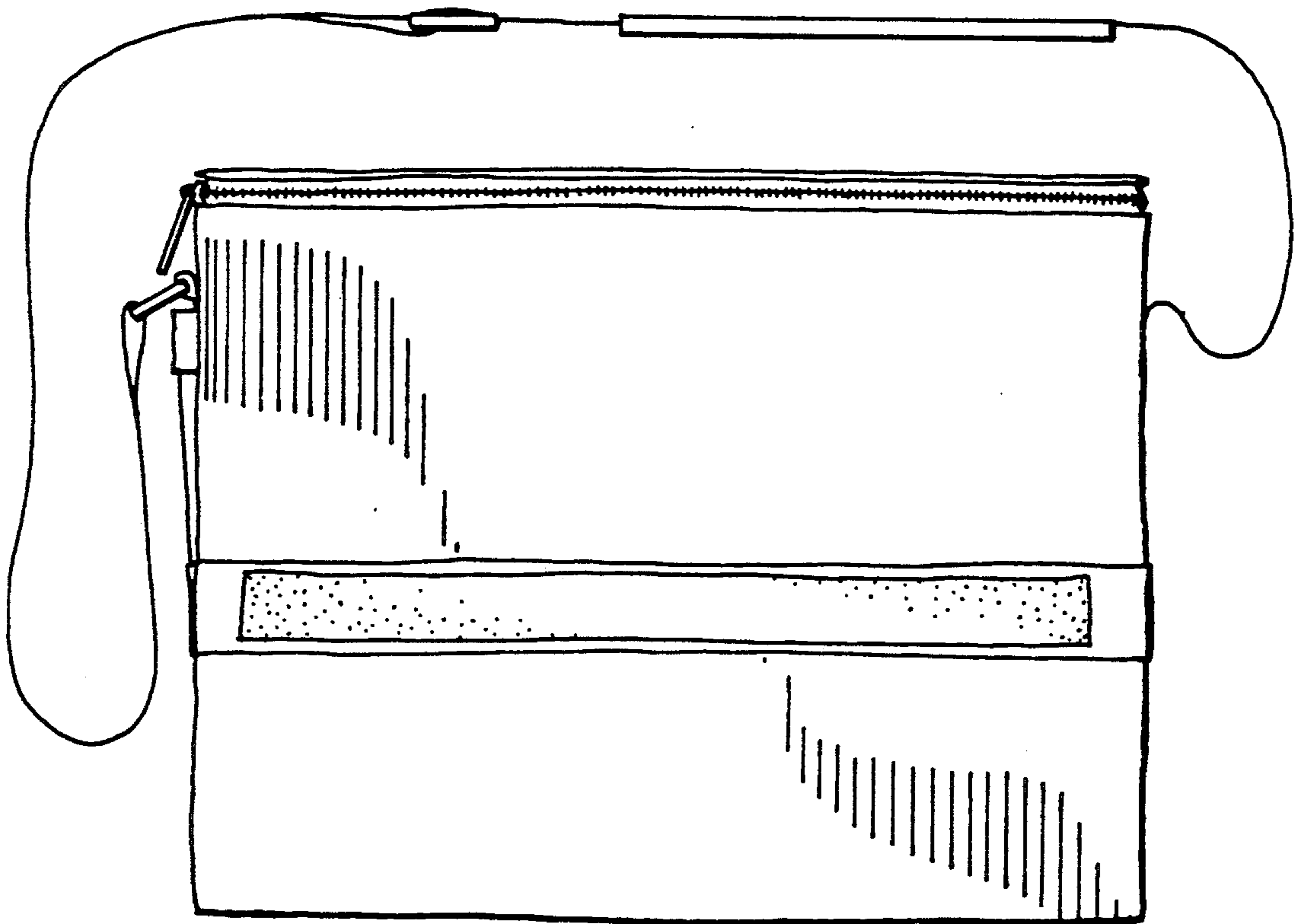

FIG. 8

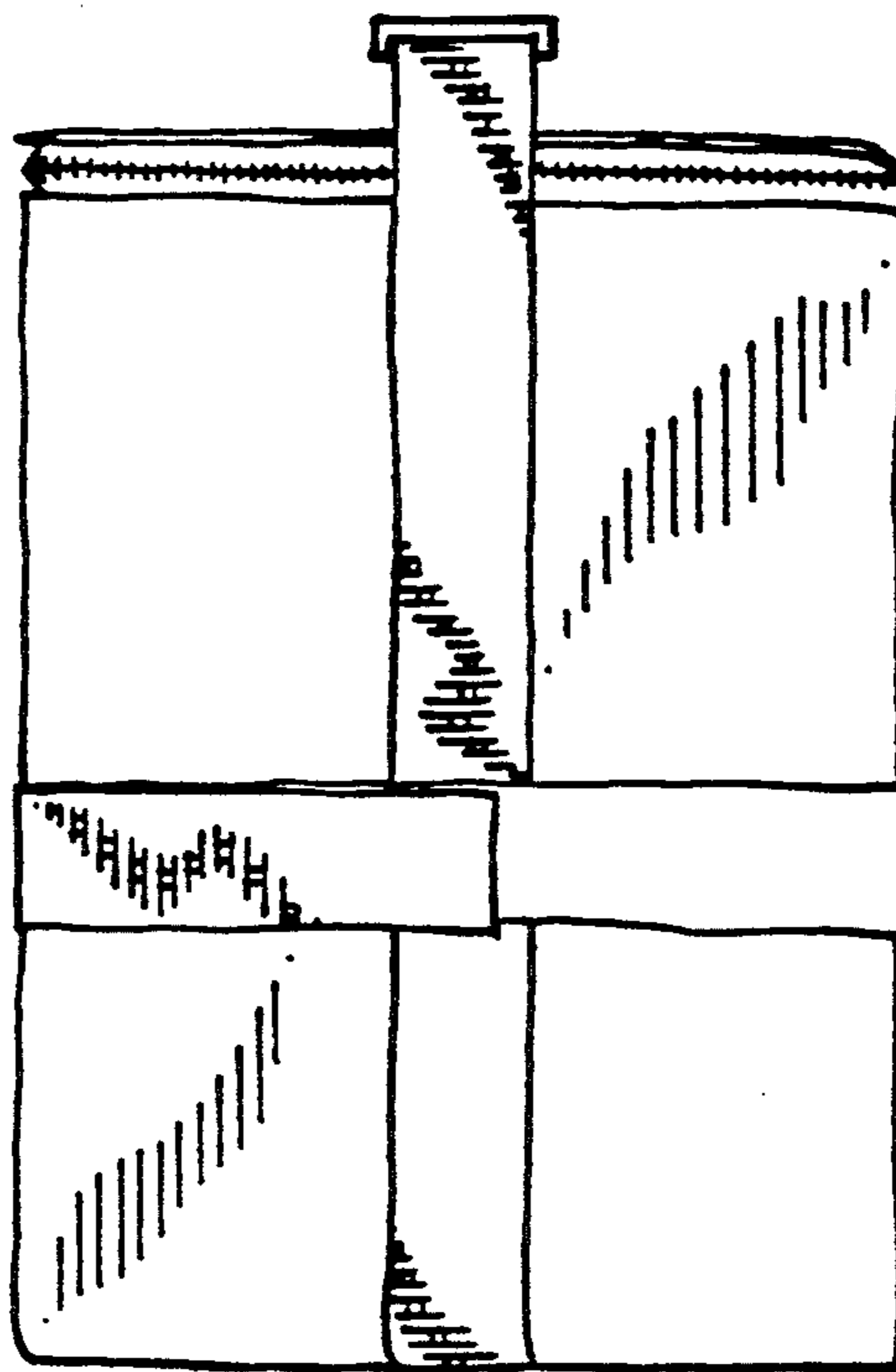

FIG. 9

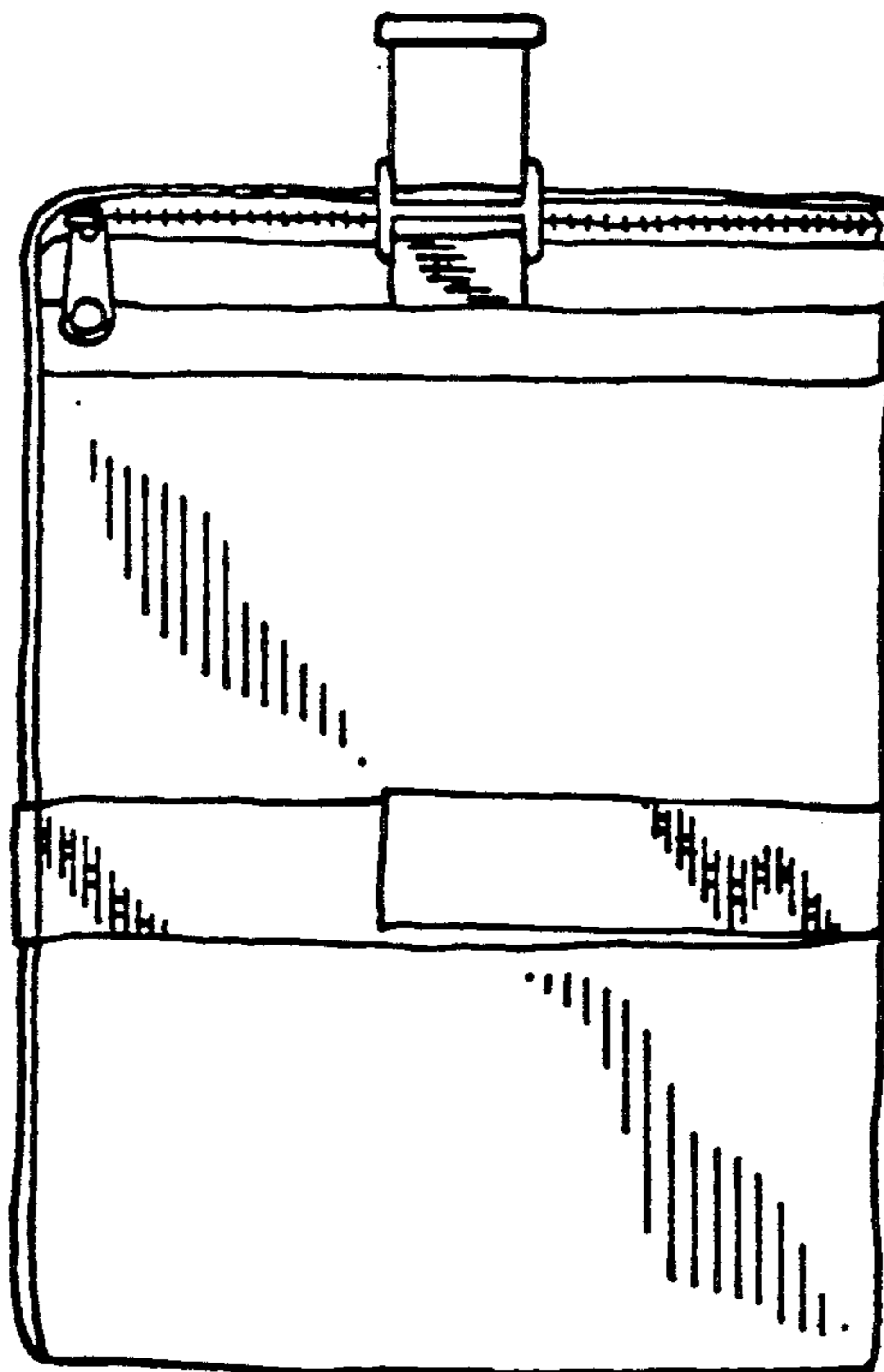

FIG. 10

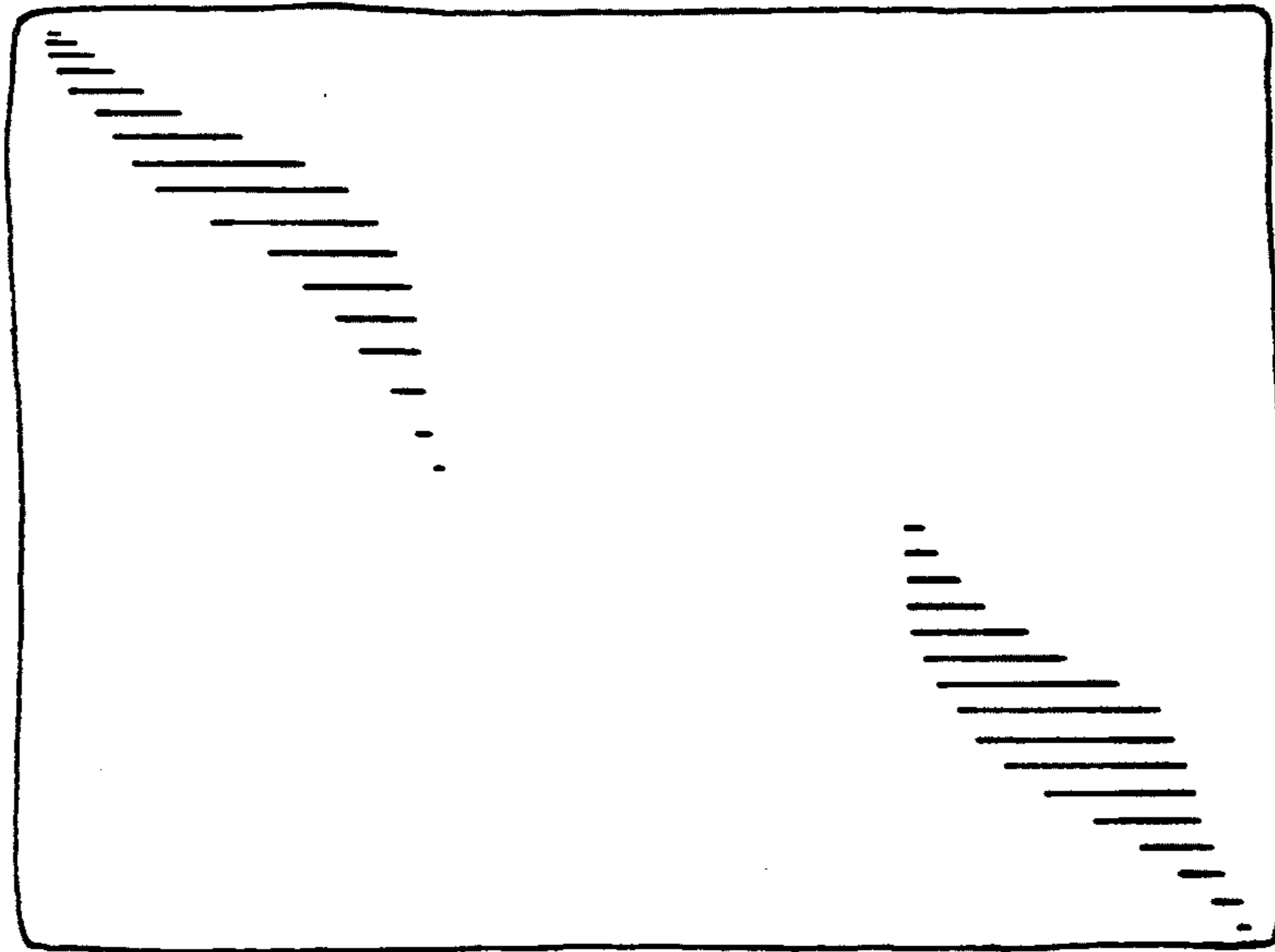

FIG. 11

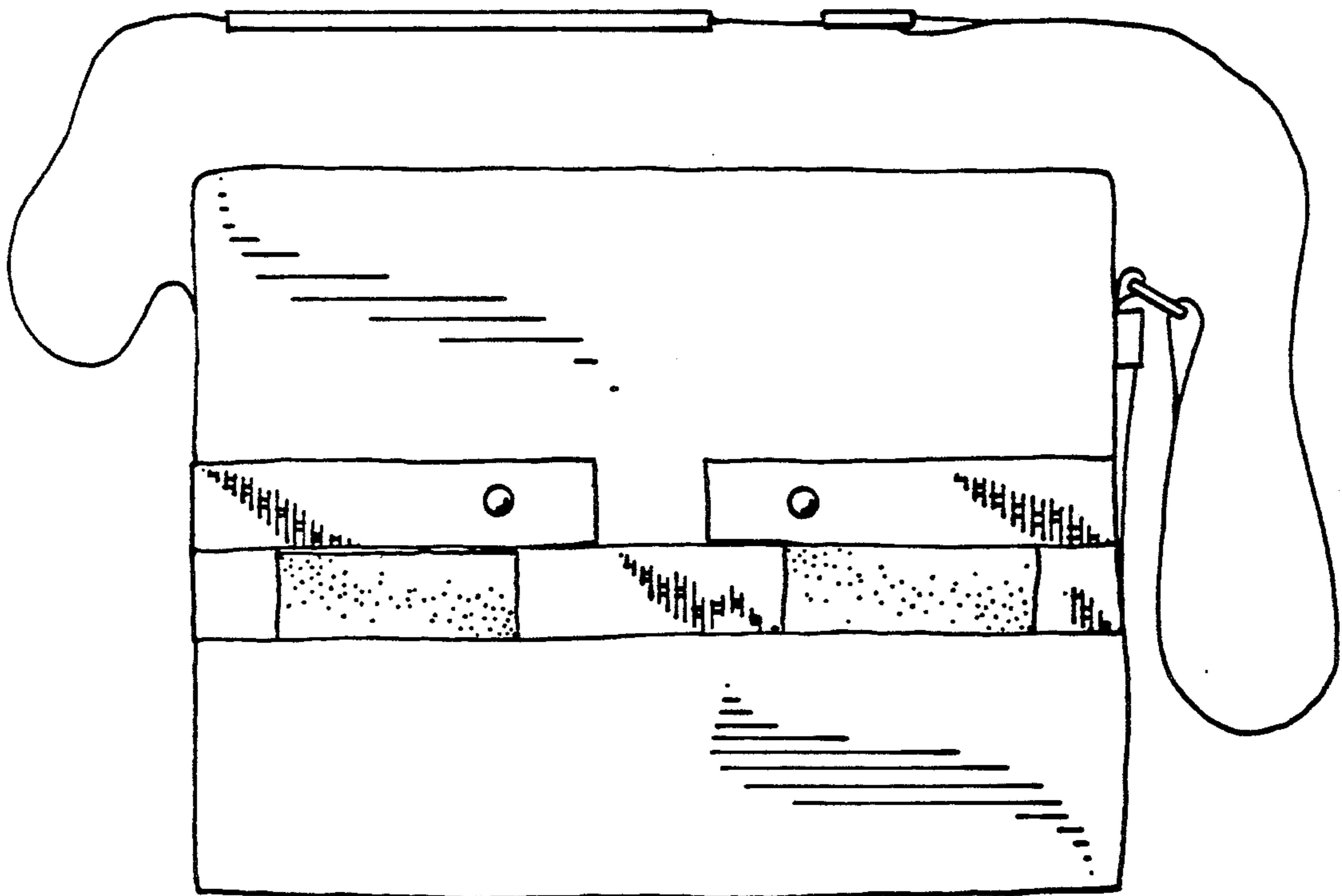

FIG. 12

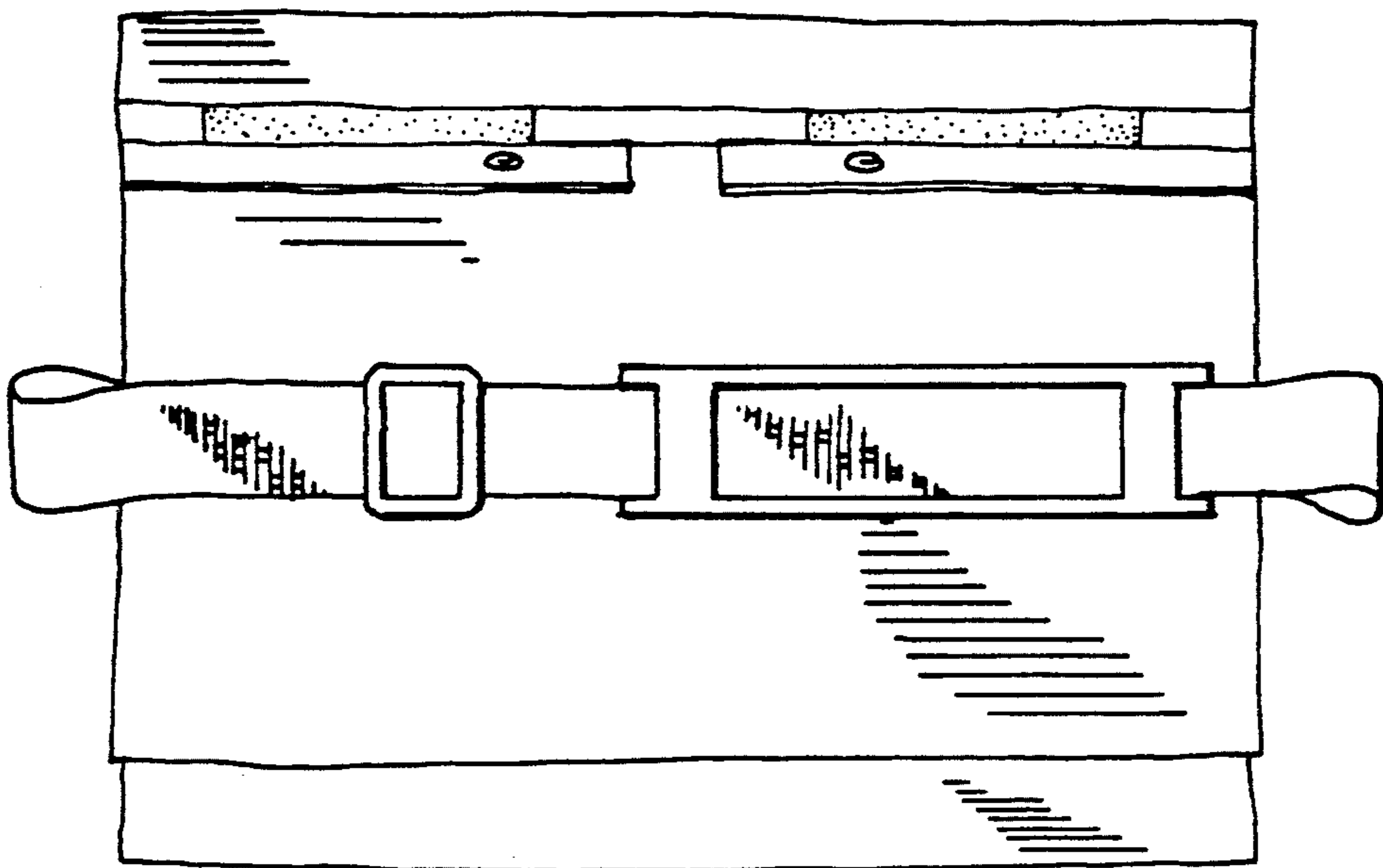

FIG. 13

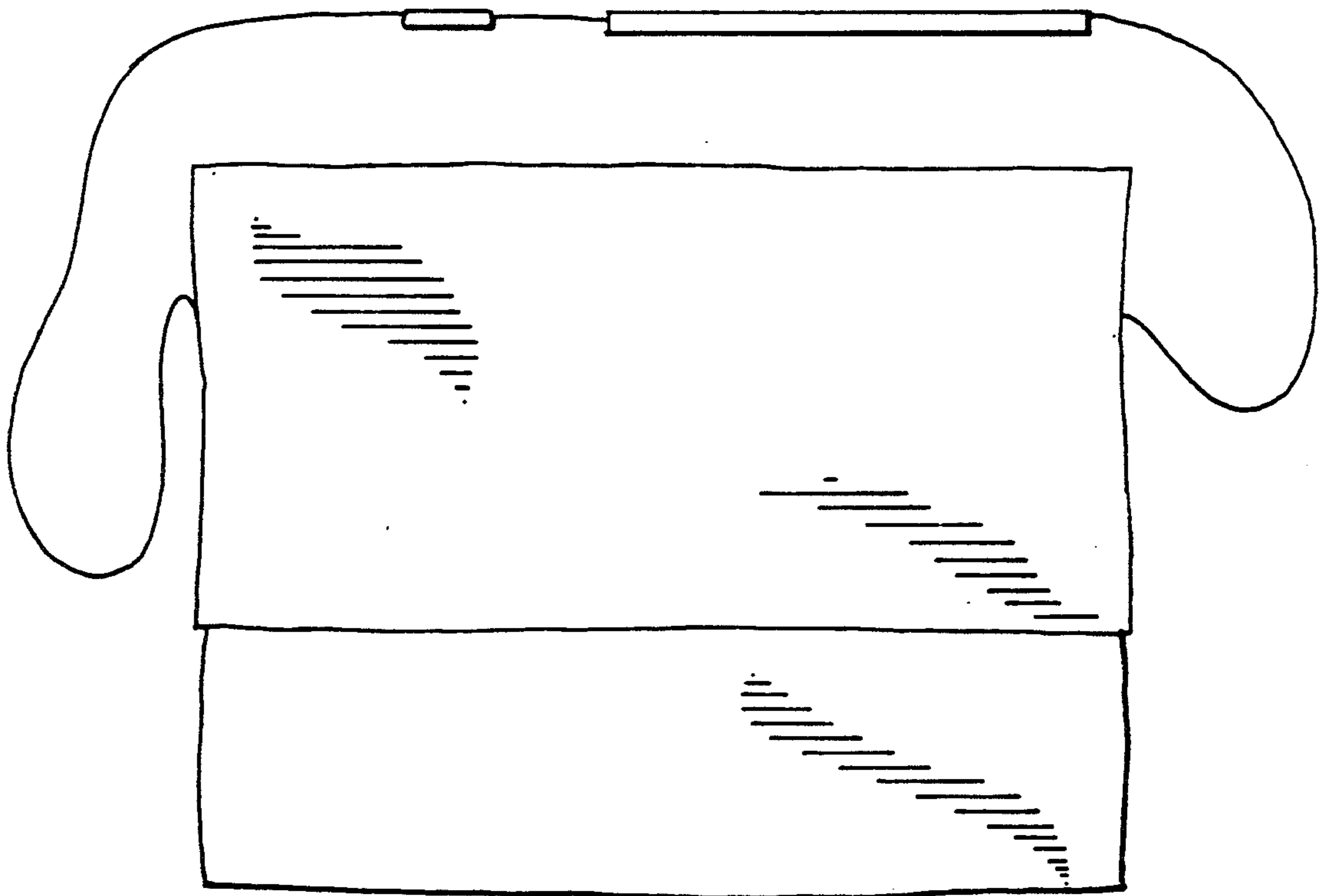

FIG. 14

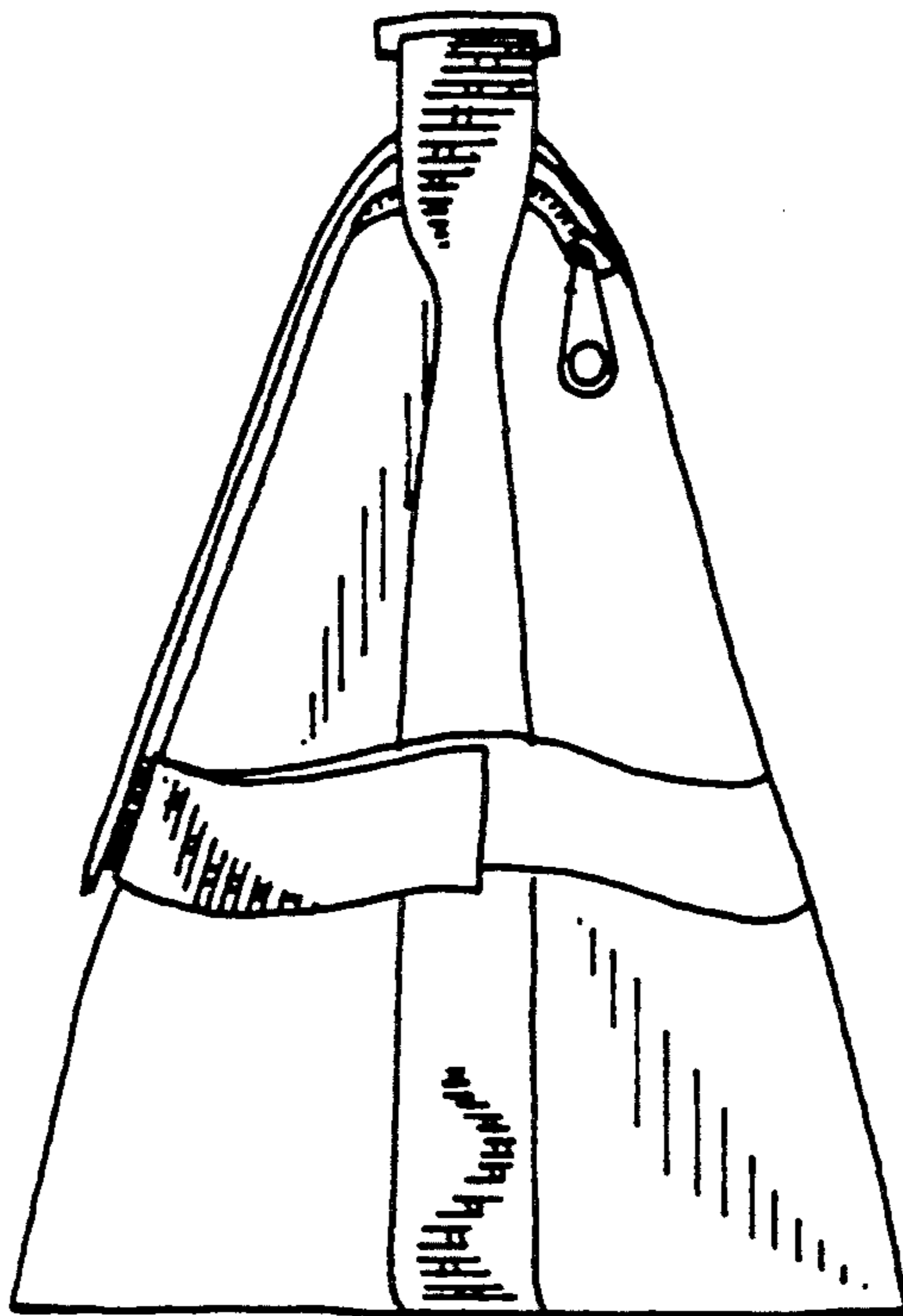

FIG. 15

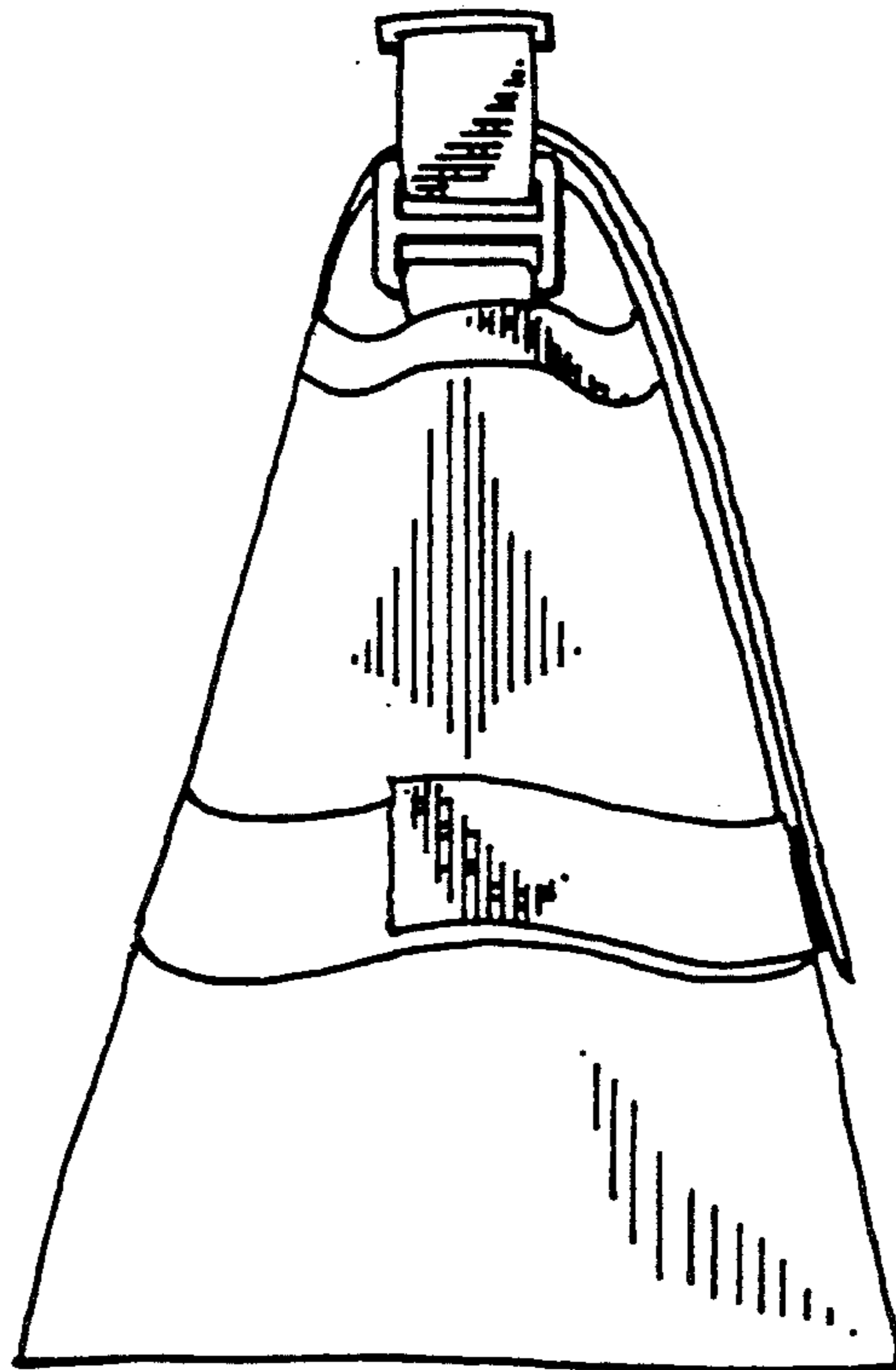

FIG. 16

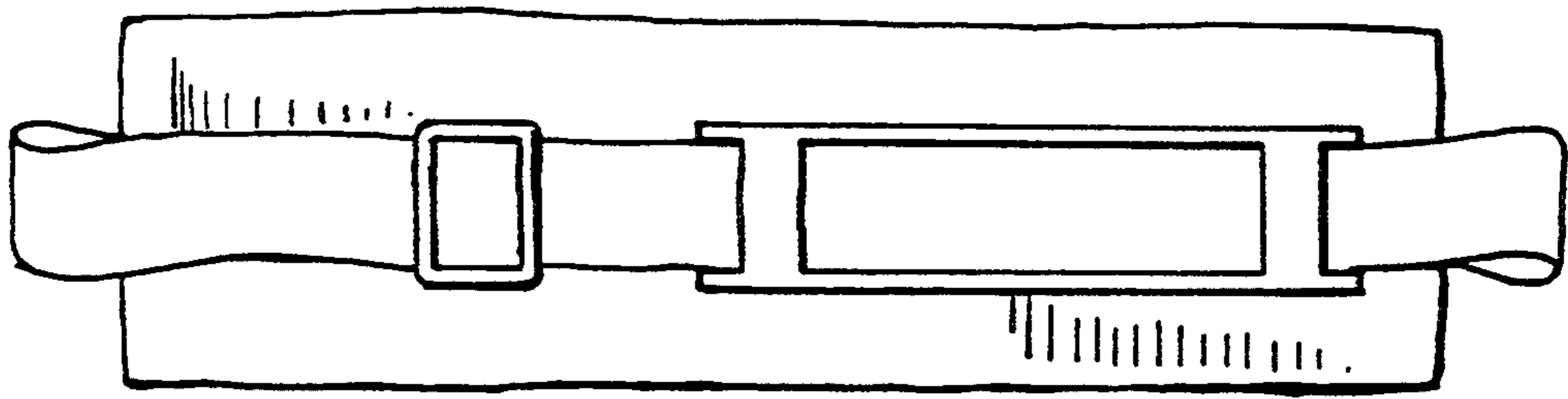

FIG. 17

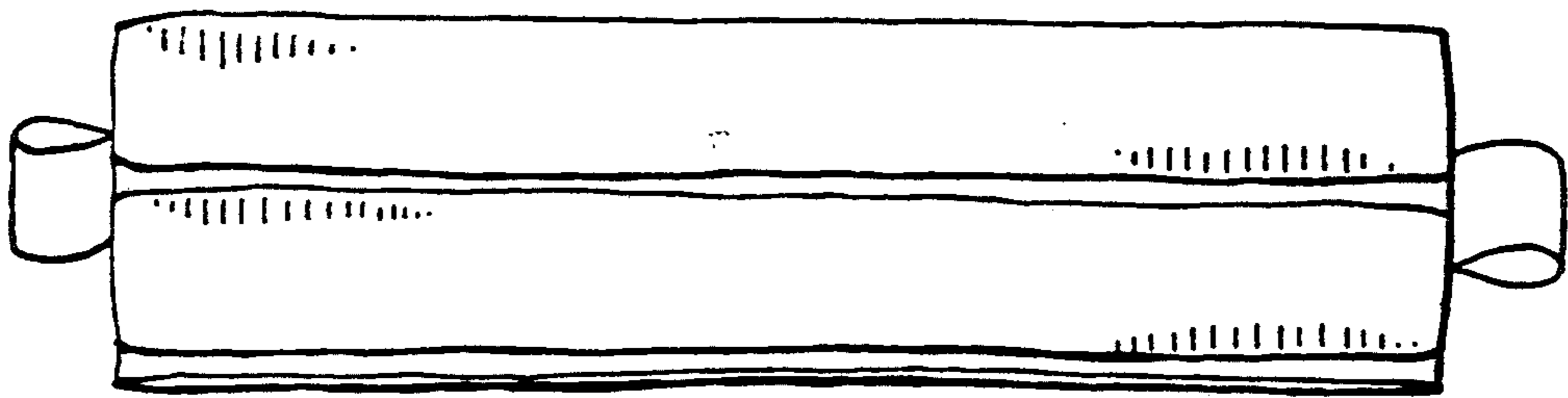

FIG. 18

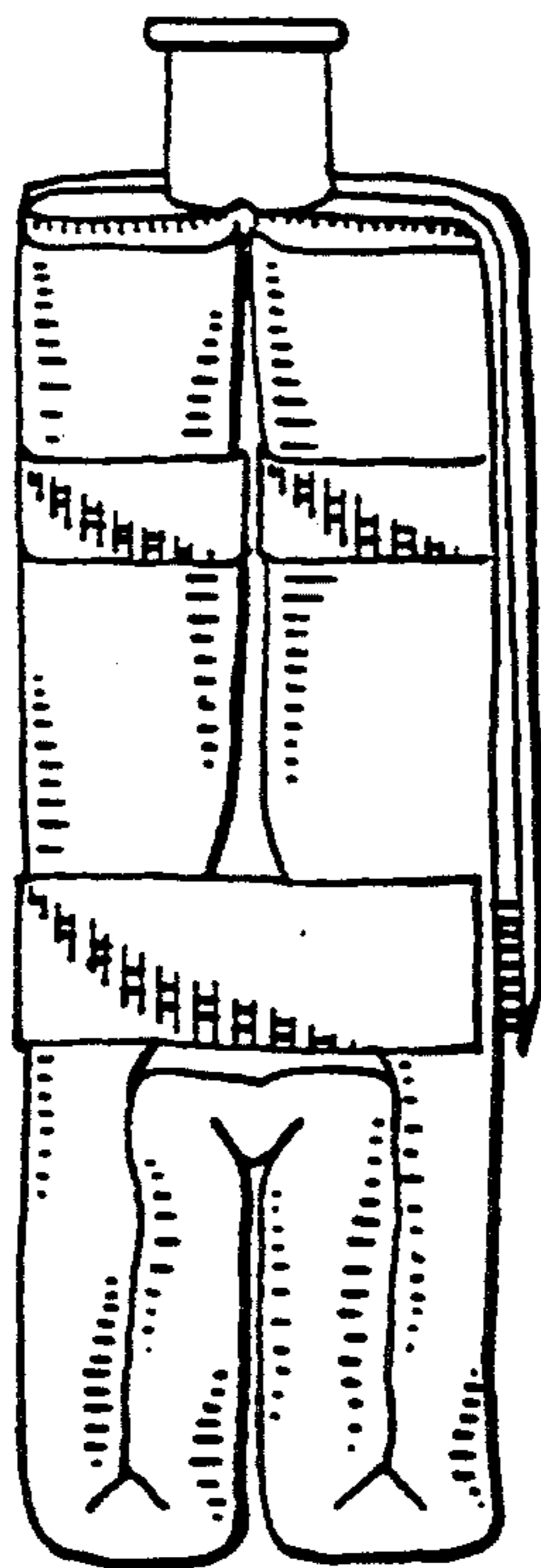

FIG. 19

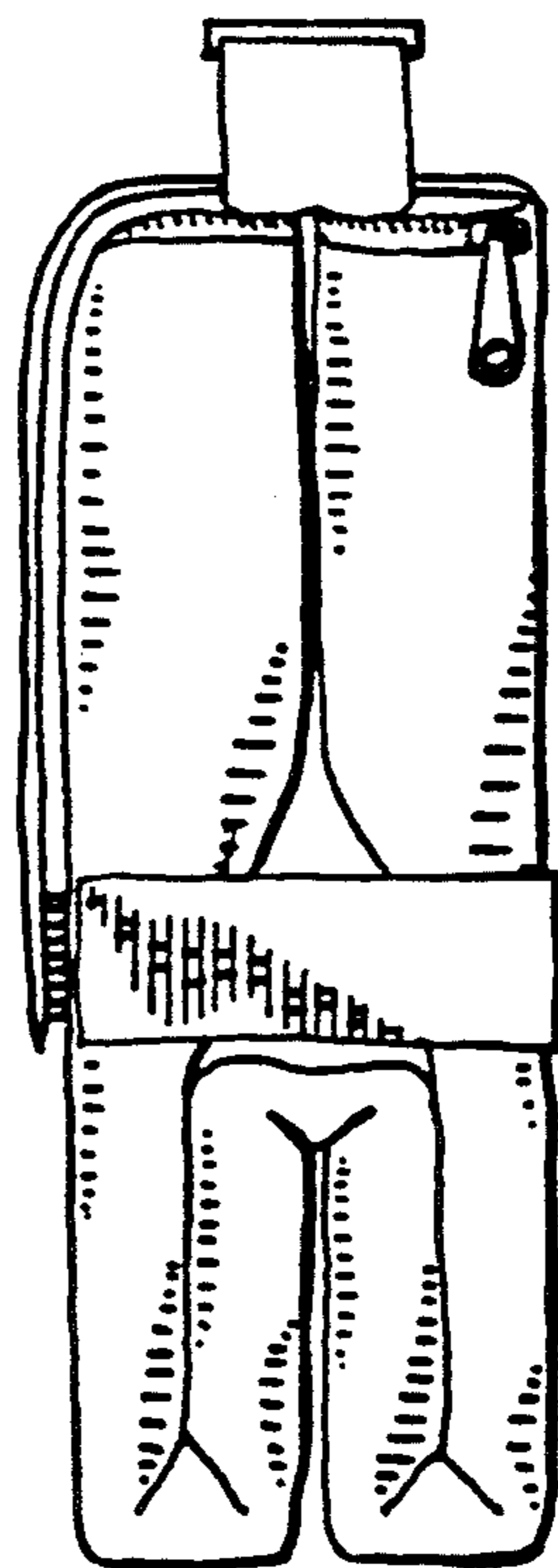

FIG. 20

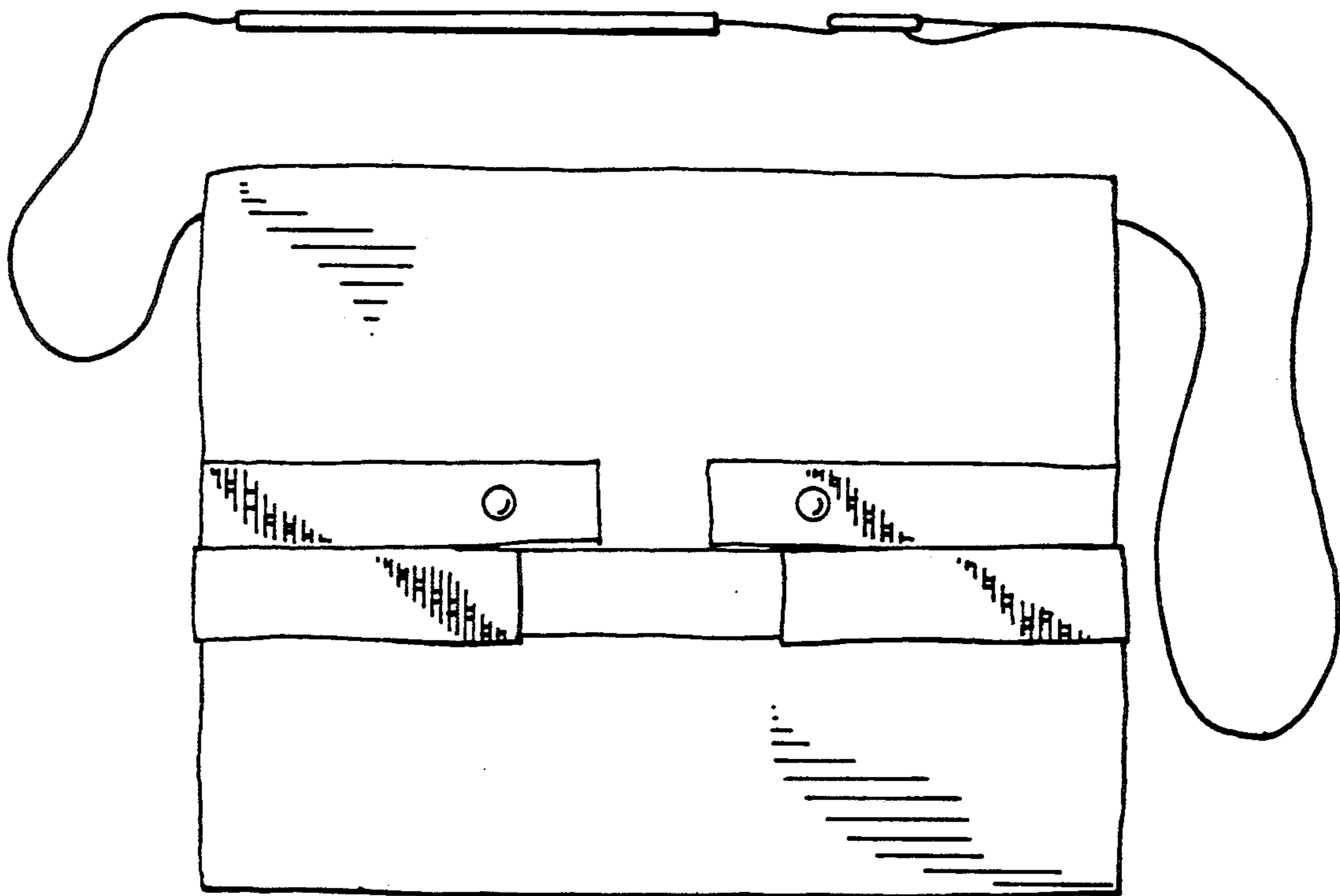

FIG.21