



US00D328542S

United States Patent [19]

[11] Patent Number: **Des. 328,542**

Carstens

[45] Date of Patent: **** Aug. 11, 1992**

[54] **BUSINESS CARD DISPENSER**

4,749,098 6/1988 Verdi 206/425 X

[76] Inventor: **Richard R. Carstens**, 1320 E. Julie Dr., Tempe, Ariz. 85283

Primary Examiner—Brian N. Vinson
Attorney, Agent, or Firm—Leon Gilden

[**] Term: **14 Years**

[57] **CLAIM**

[21] Appl. No.: **402,426**

The ornamental design for a business card dispenser, as shown and described.

[22] Filed: **Sep. 5, 1989**

DESCRIPTION

[52] U.S. Cl. **D6/515**
[58] Field of Search **D6/512, 515, 517;**
206/425, 37, 39, 39.5, 425; 211/13, 86; 221/185,
282-286

FIG. 1 is a front elevational view of a business card dispenser showing my new design;
FIG. 2 is a rear elevational view thereof;
FIG. 3 is a left side elevational view thereof;
FIG. 4 is a right side elevational view thereof;
FIG. 5 is a top plan view thereof;
FIG. 6 is a bottom plan view thereof;
FIG. 7 is a fragmentary vertical cross-sectional view thereof, taken along line 7—7 of FIG. 5; and,
FIG. 8 is a vertical cross-sectional view thereof, taken along line 8—8 of FIG. 7.

[56] **References Cited**

U.S. PATENT DOCUMENTS

D. 318,201	7/1991	King	D6/518
1,955,633	4/1934	Hill	206/39 X
3,710,929	1/1973	Morales	206/39.5
4,170,914	10/1979	Carrier	206/39.5 X

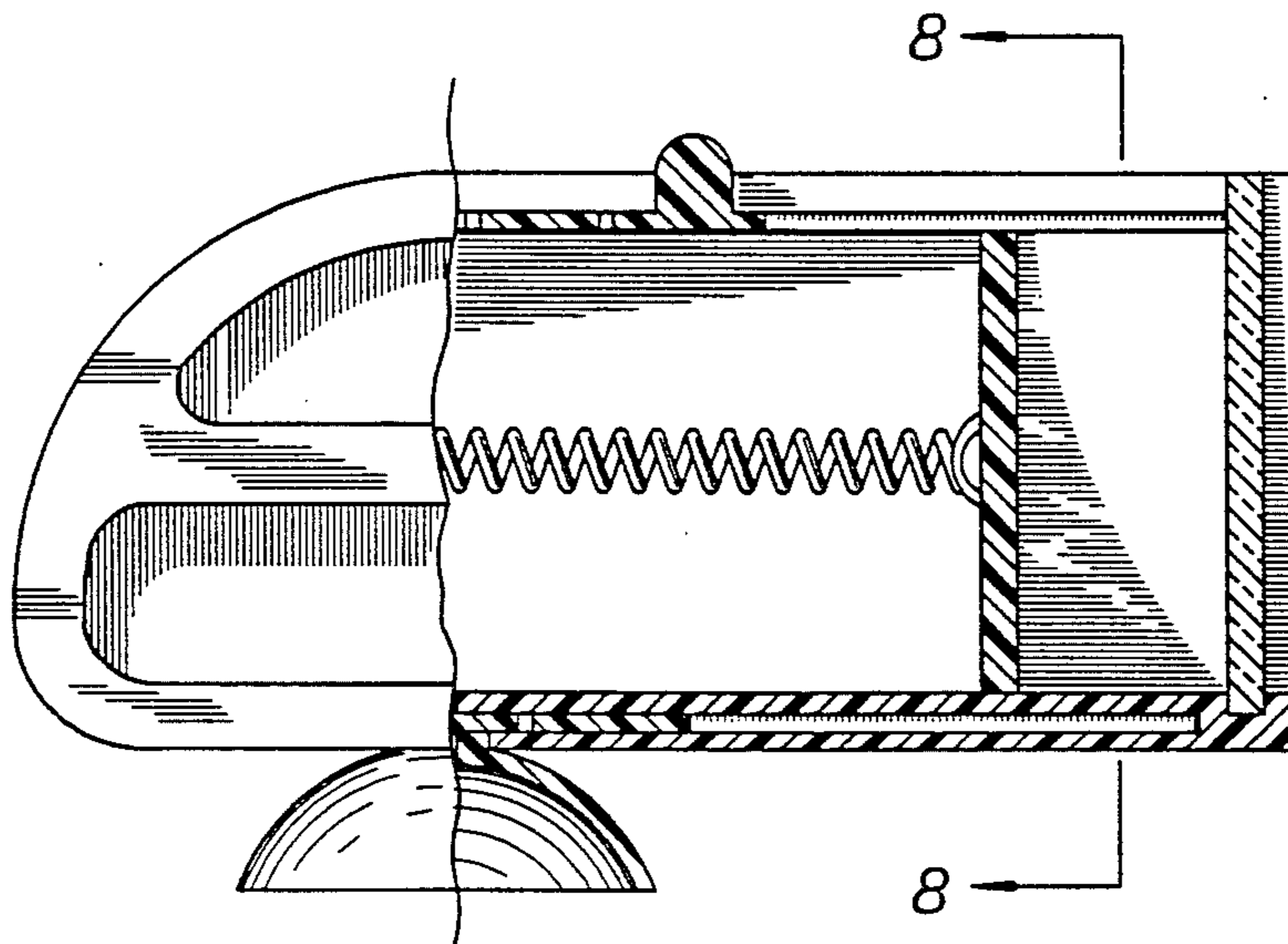
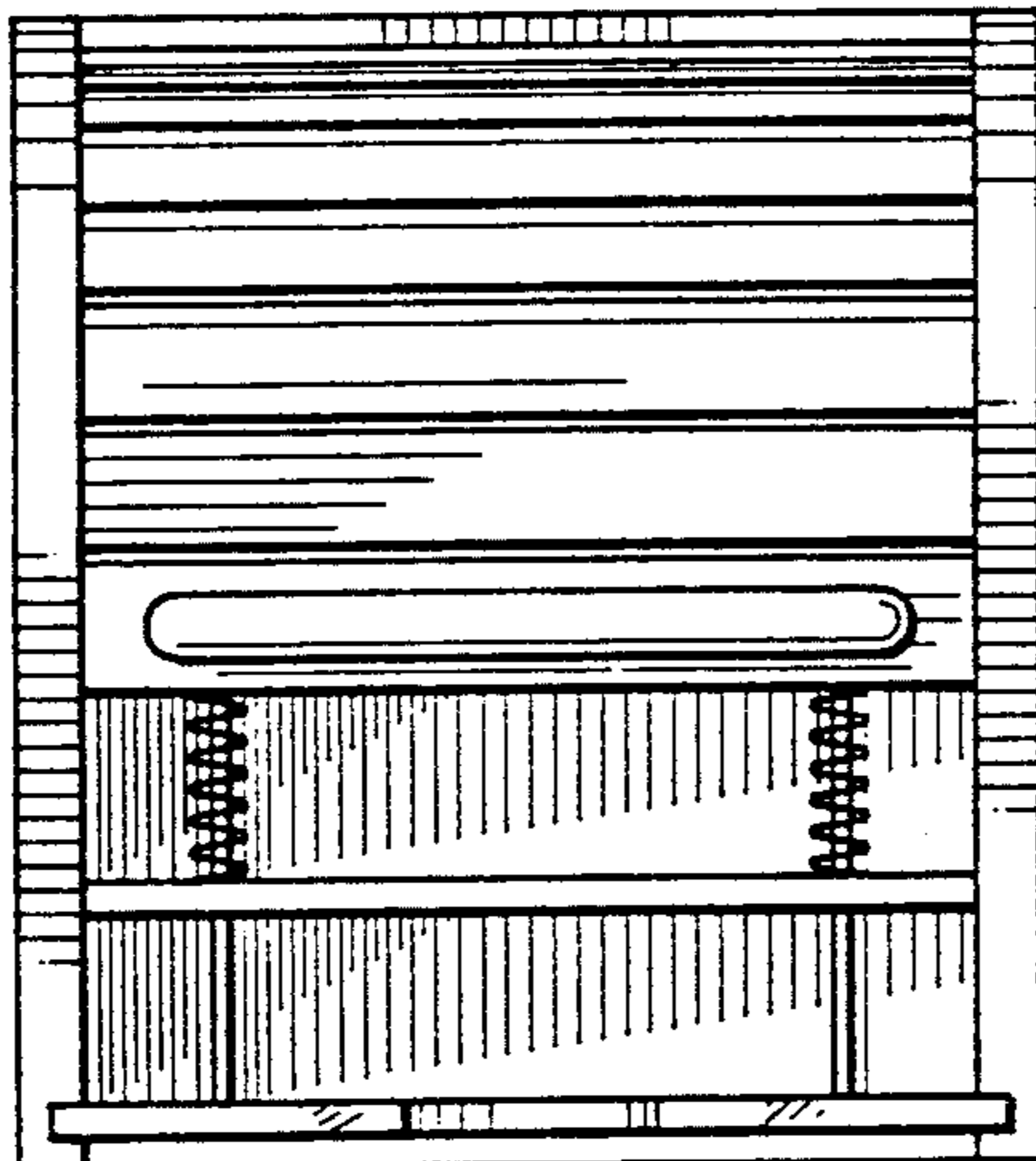

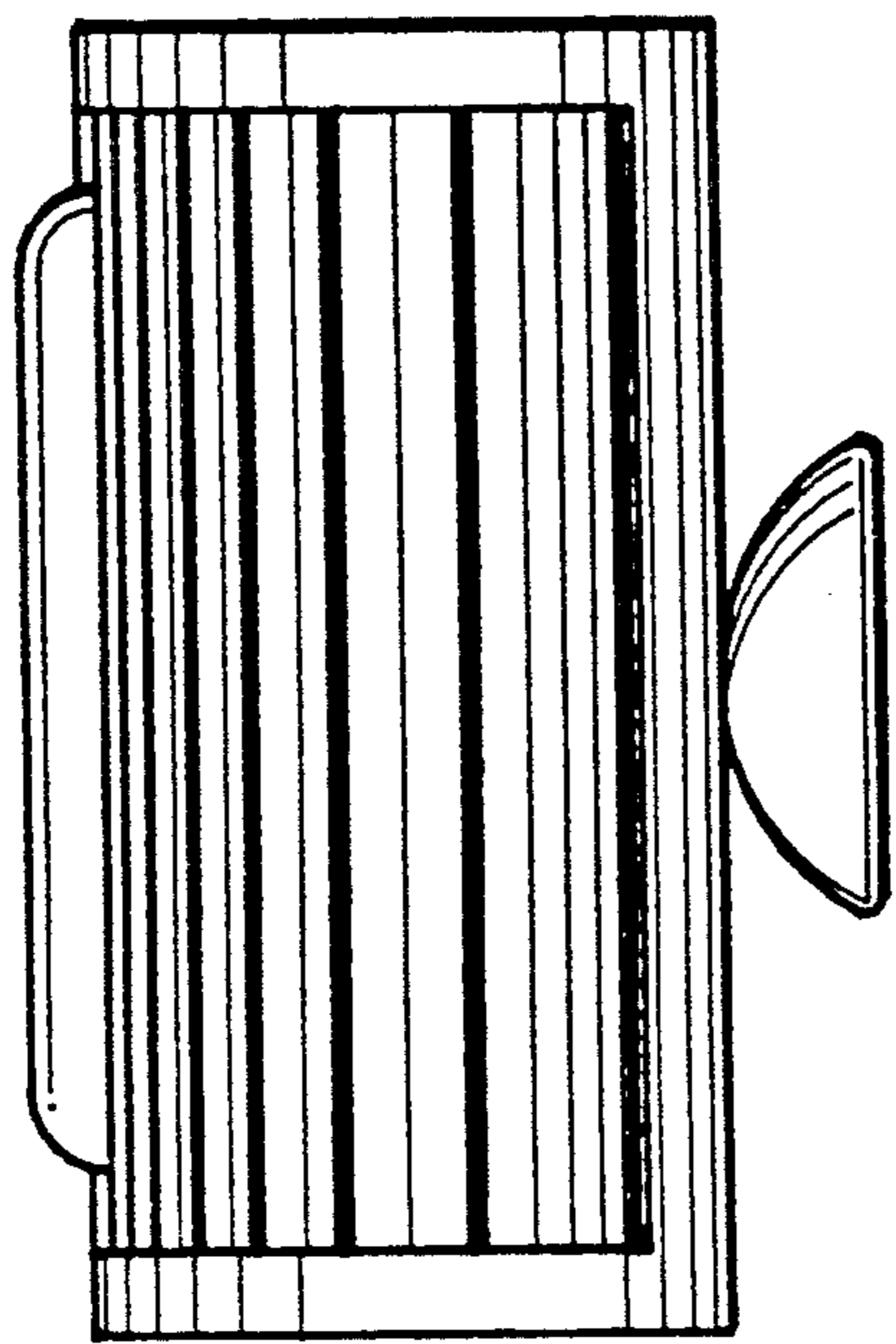

Fig. 1

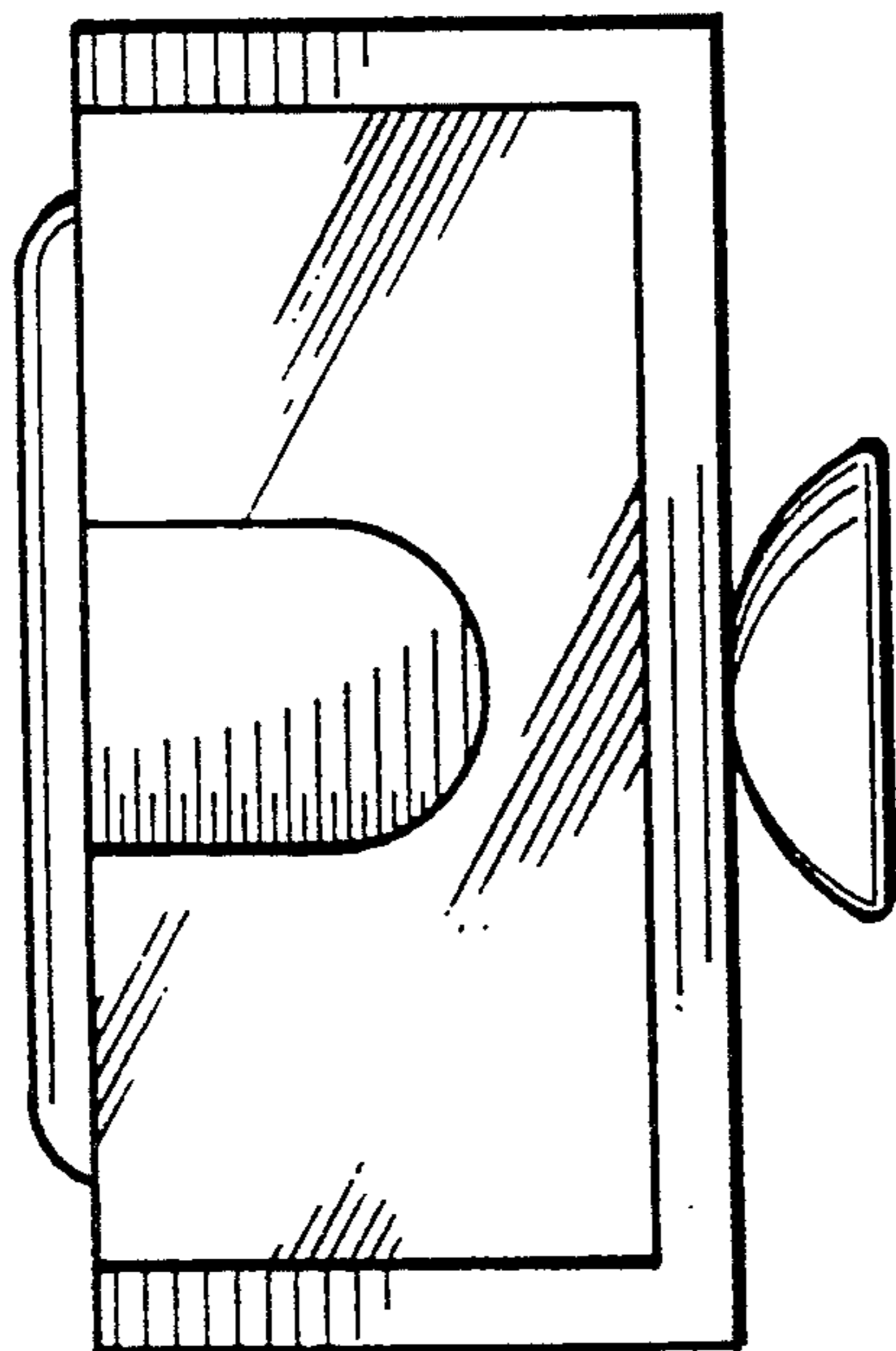

Fig. 2

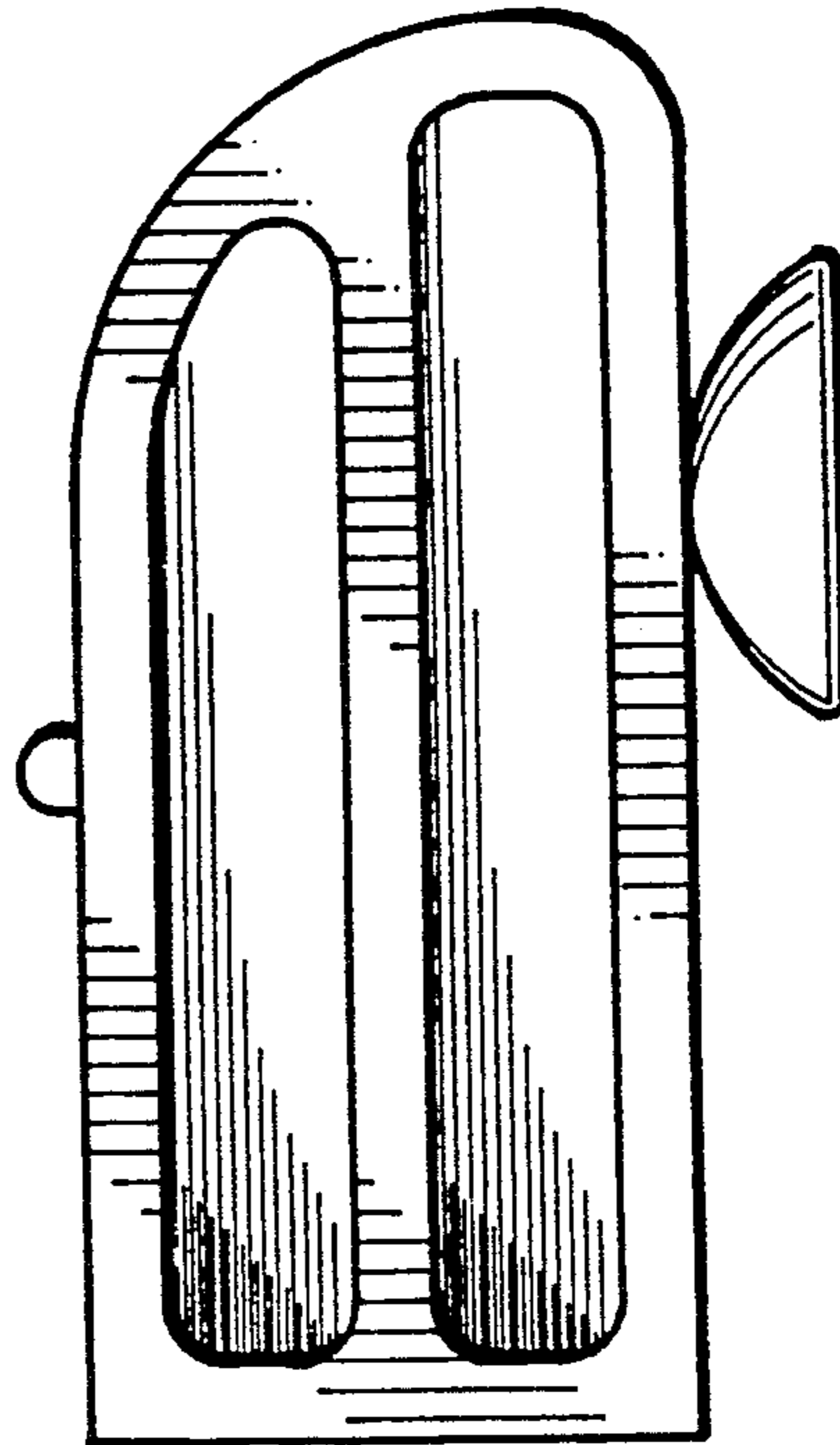

Fig. 3

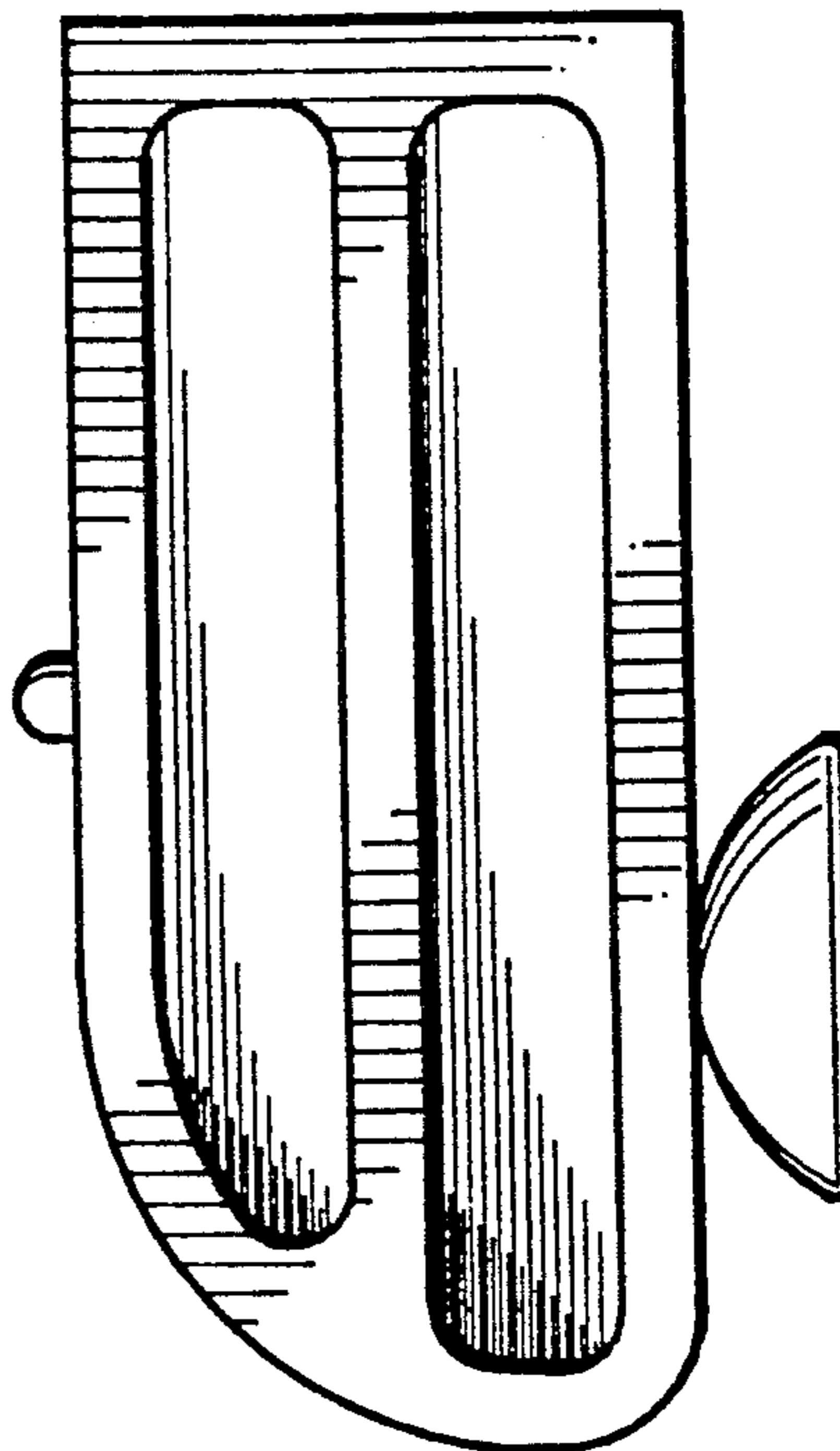

Fig. 4

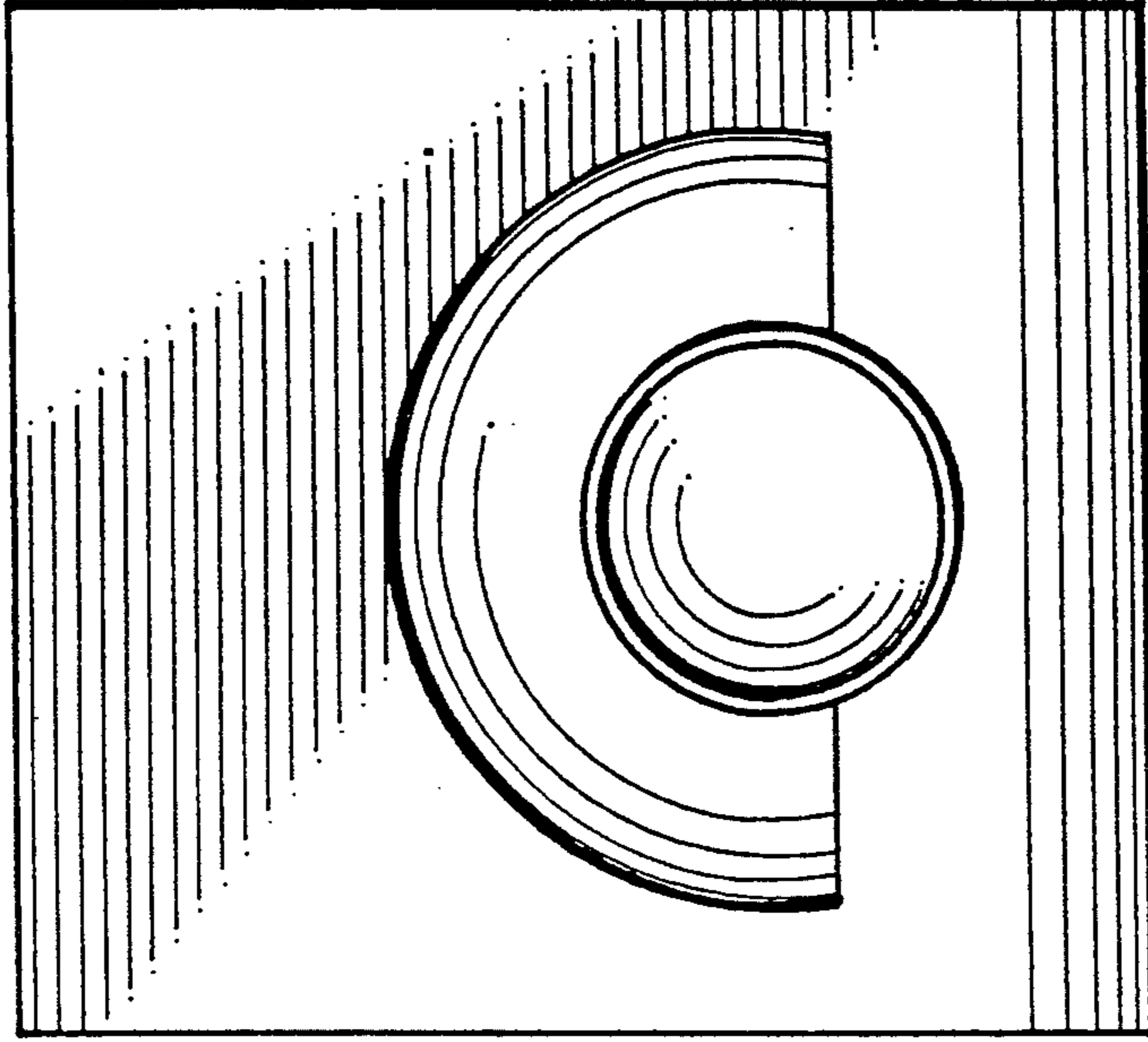

Fig. 6

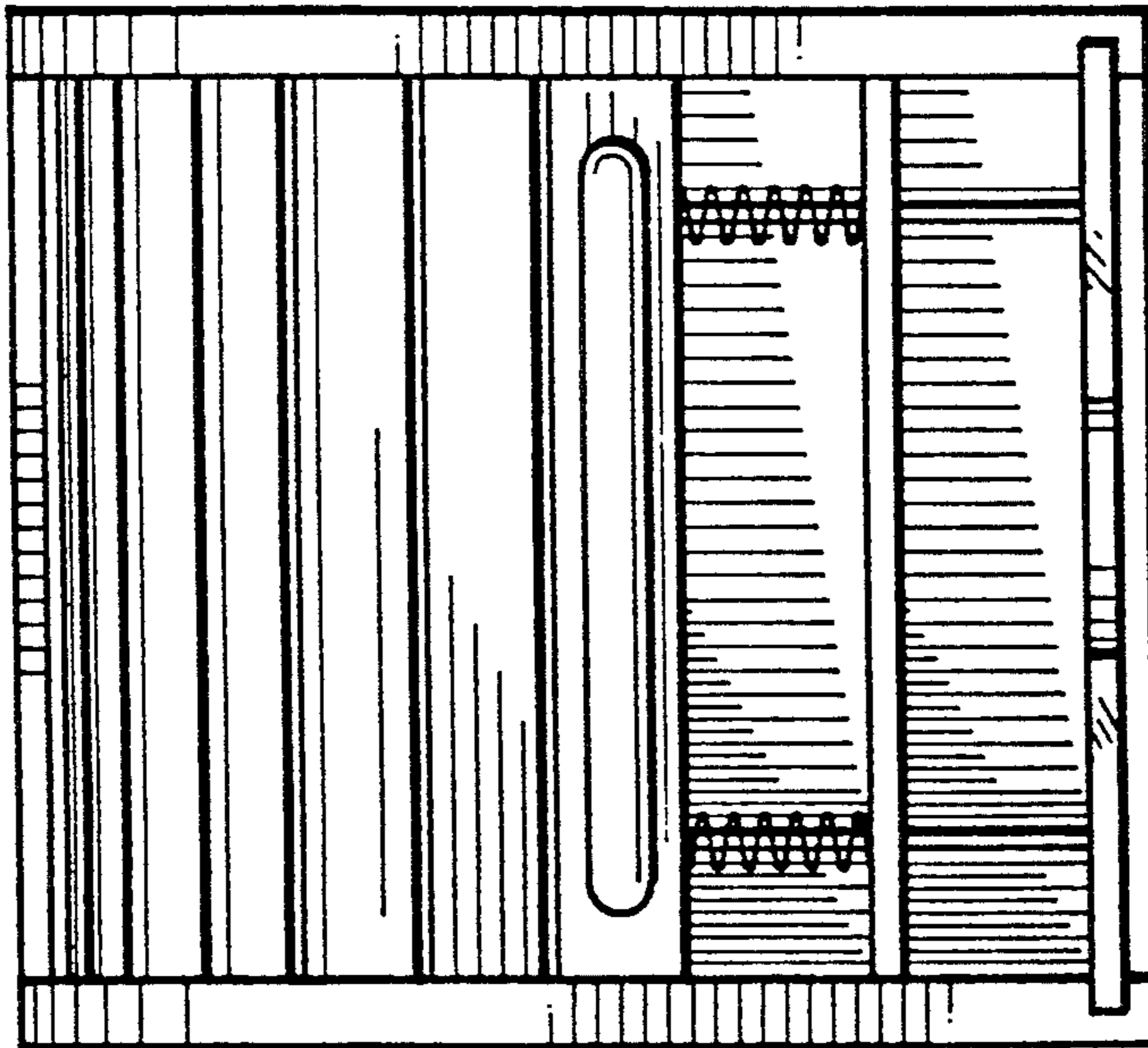

Fig. 5

