



US00D328448S

United States Patent [19]

[11] Patent Number: **Des. 328,448**

Gamauf

[45] Date of Patent: **** Aug. 4, 1992**

[54] **REMOVABLE PLATFORM FOR MOUNTING ON A VEHICLE BUMPER**

4,405,141	9/1983	Jurek	280/163
4,620,609	11/1986	Elsten	280/163
4,721,319	1/1988	Dale	182/92

[76] Inventor: **Richard Gamauf**, 2325 SE. 16th St., Cape Coral, Fla. 33990

Primary Examiner—James M. Gandy
Attorney, Agent, or Firm—William E. Noonan

[**] Term: **14 Years**

[57] **CLAIM**

[21] Appl. No.: **460,618**

The ornamental design for a removable platform for mounting on a vehicle bumper, as shown.

[22] Filed: **Jan. 2, 1990**

[52] U.S. Cl. **D12/203**

DESCRIPTION

[58] Field of Search **D12/203; D25/62,69; 280/163, 164.1; 182/92, 120; D8/349, 354, 396**

FIG. 1 is a top plan view of the removable platform for mounting on a vehicle bumper of this invention; FIG. 2 is a left side elevational view thereof; FIG. 3 is a right side elevational view thereof; FIG. 4 is a bottom plan view thereof; FIG. 5 is a front elevational view thereof; FIG. 6 is a rear elevational view thereof; and, FIG. 7 is a bottom perspective view thereof.

[56] **References Cited**

U.S. PATENT DOCUMENTS

D. 263,132	2/1982	Mitchell	D12/203
D. 290,833	7/1987	Walters	D12/203
D. 296,321	6/1988	Hayes	D12/203
3,357,719	12/1967	McCrea	280/163

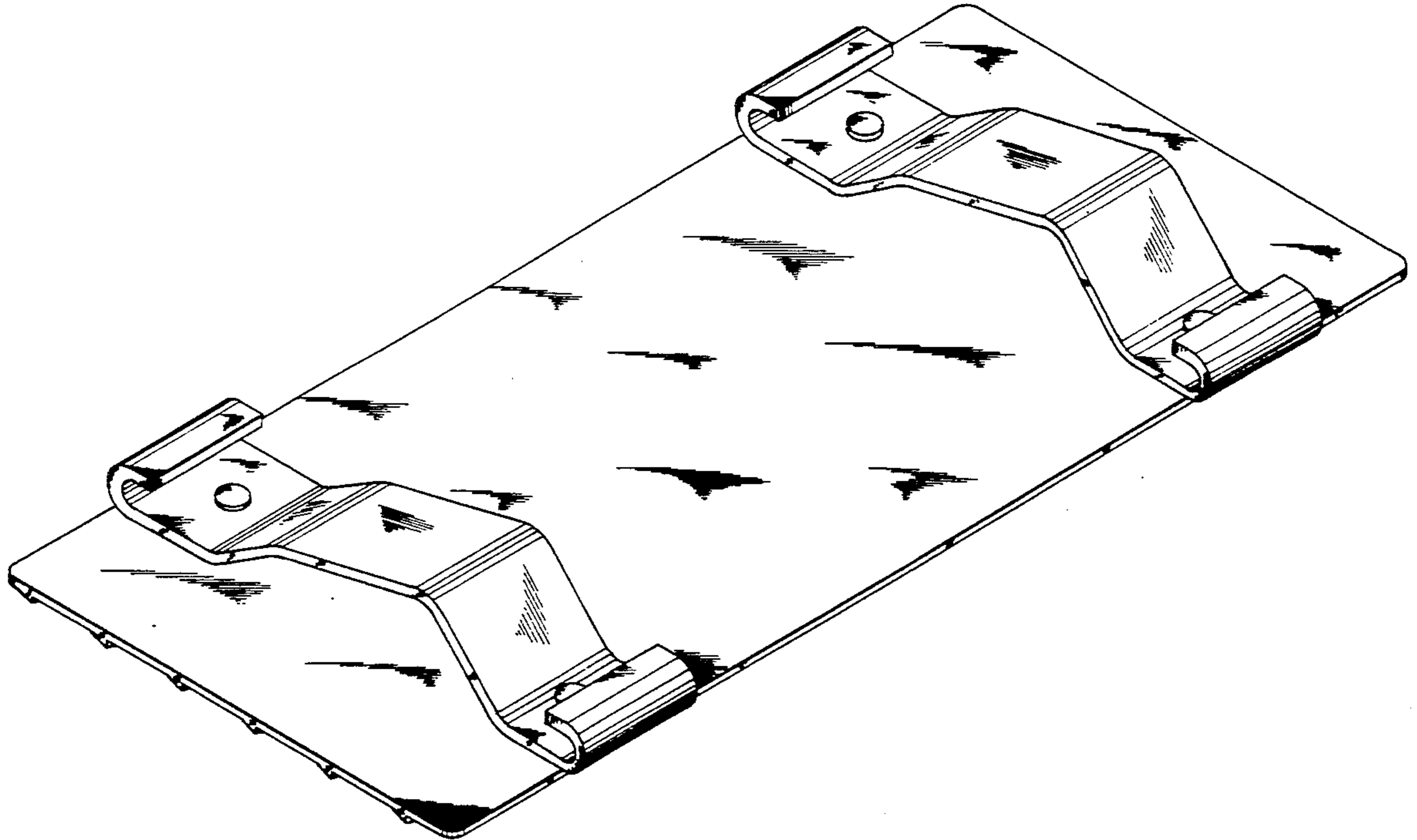

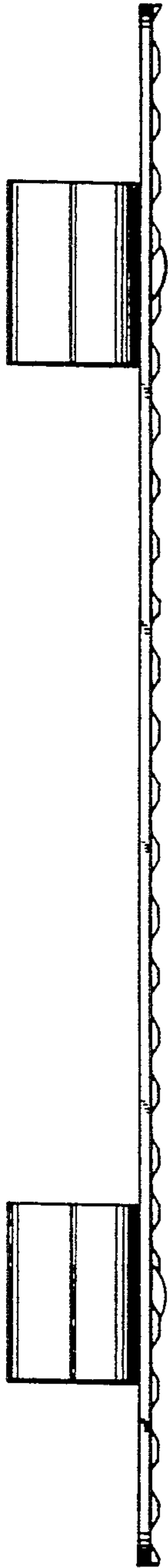

Fig. 6

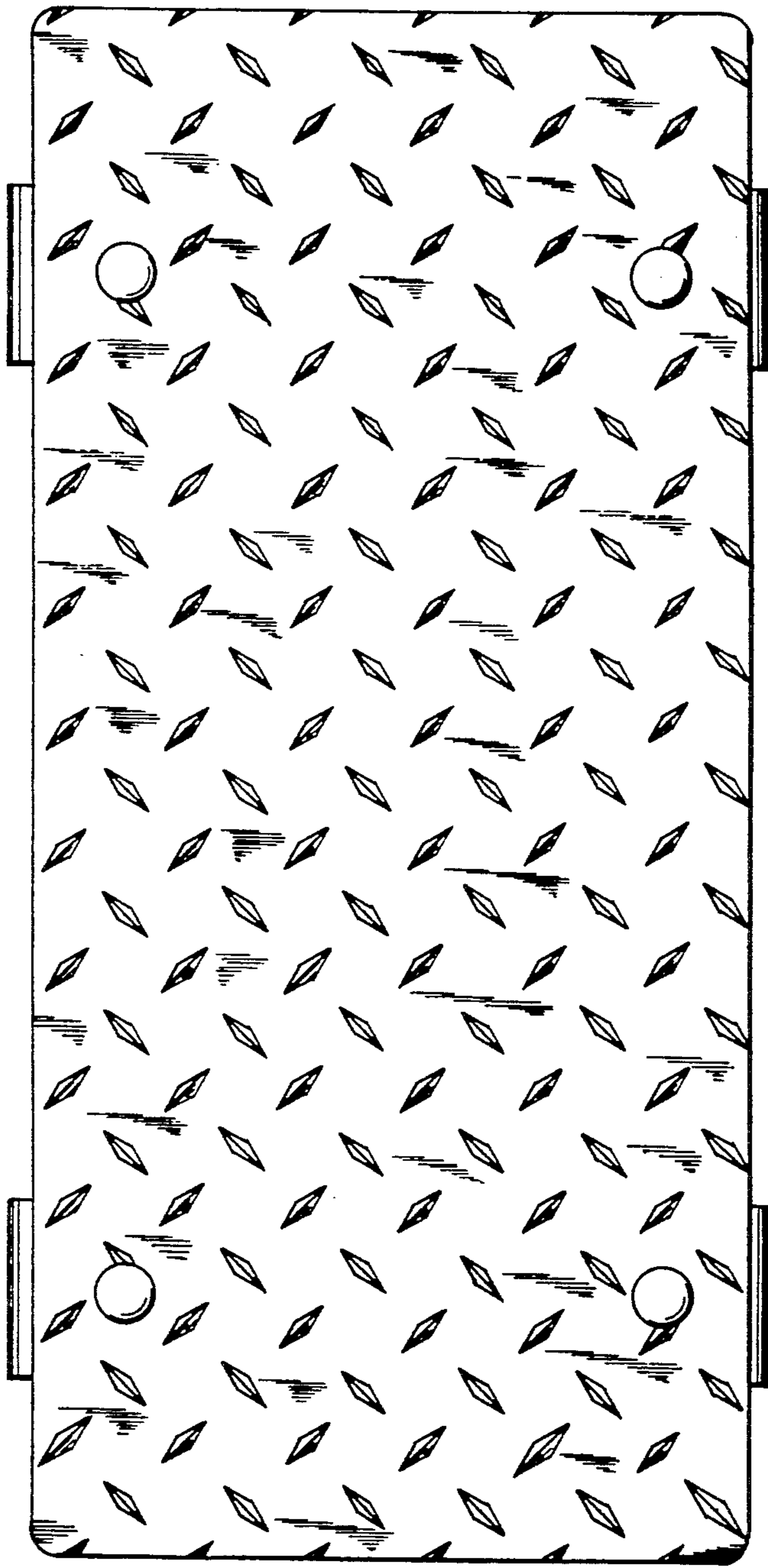

Fig. 1

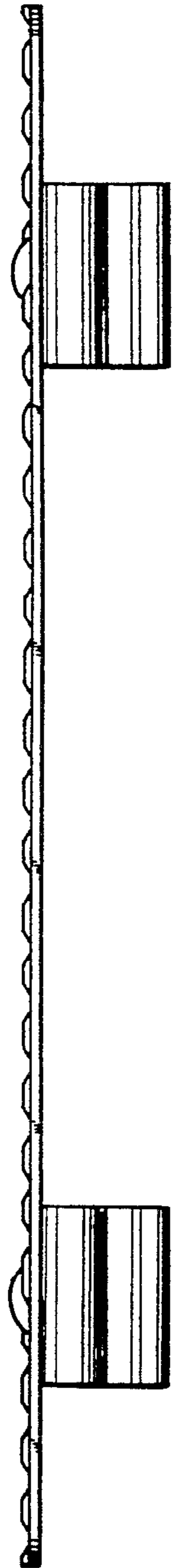

Fig. 5

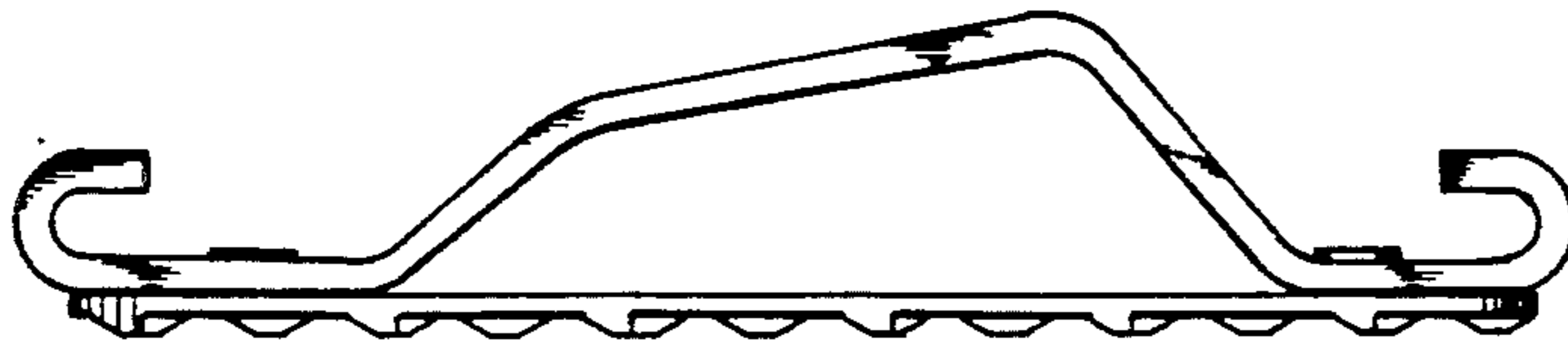

Fig. 2

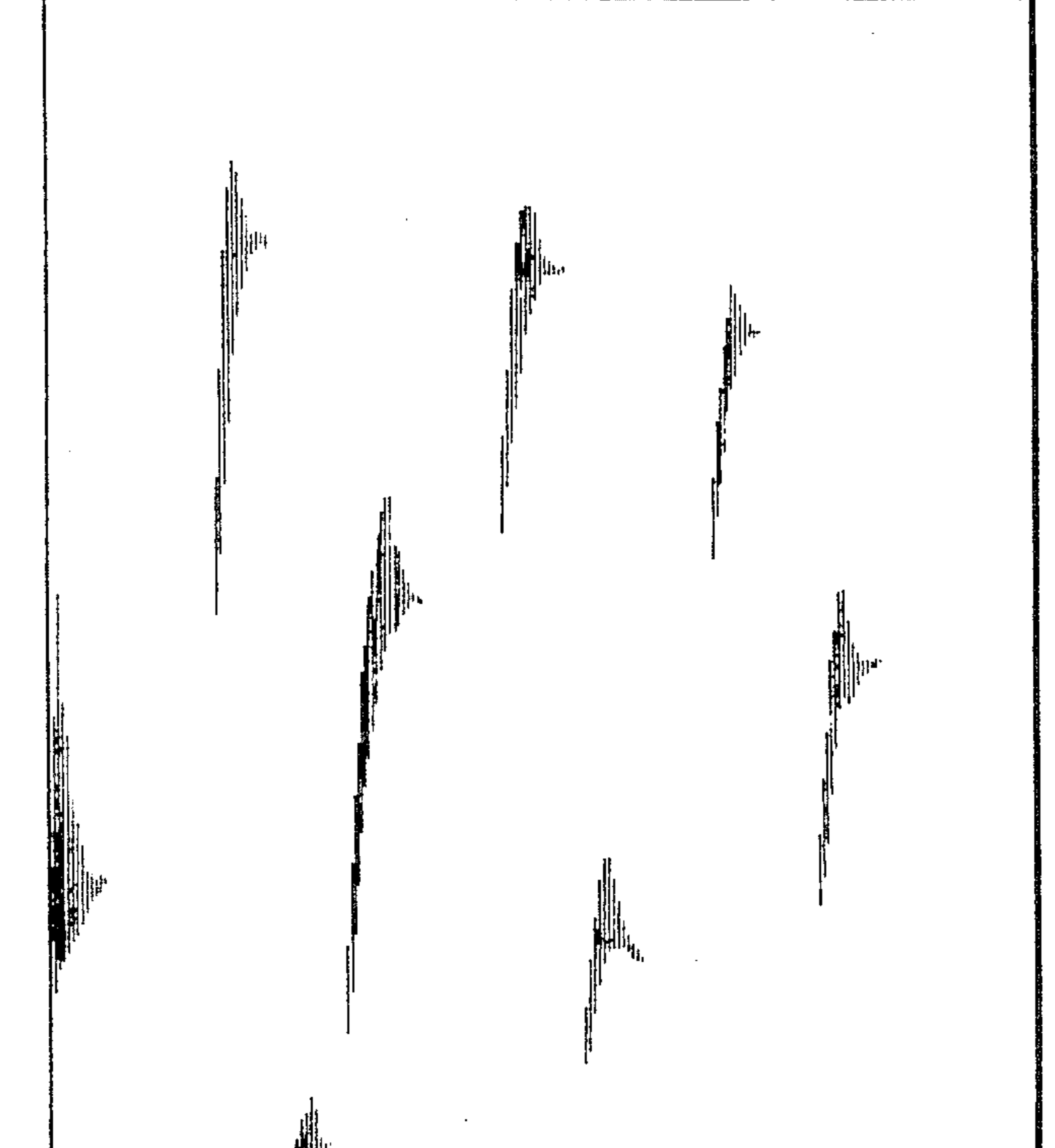
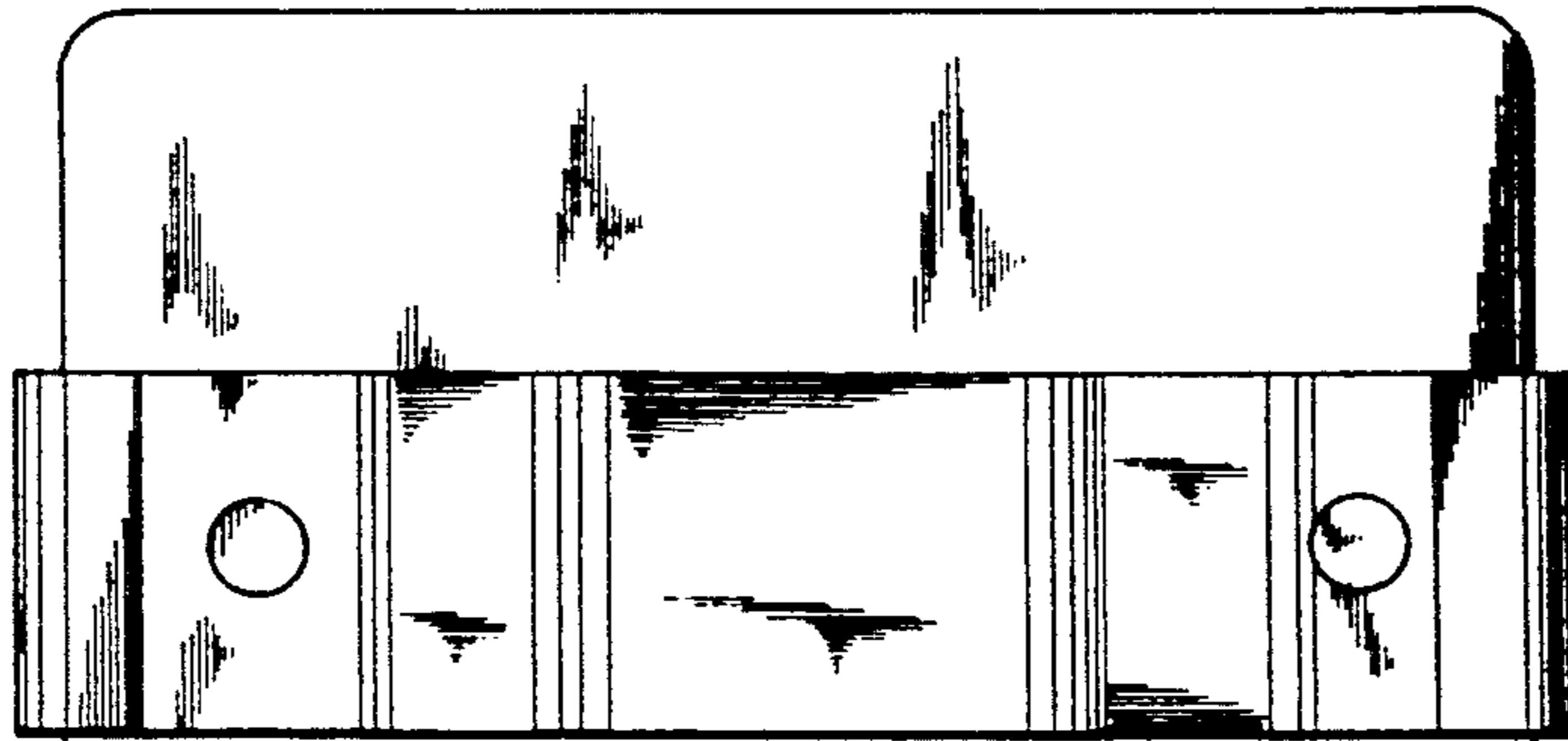

Fig. 4

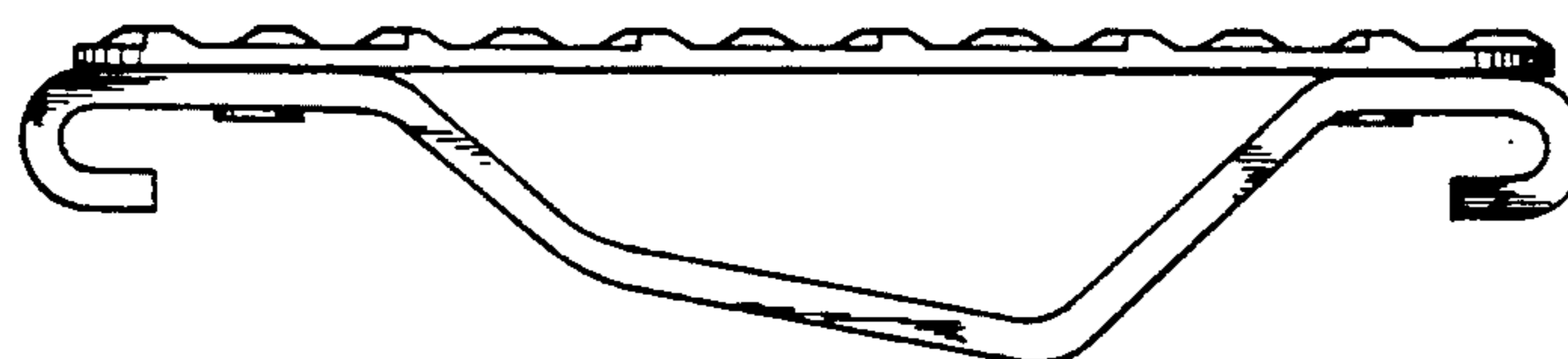
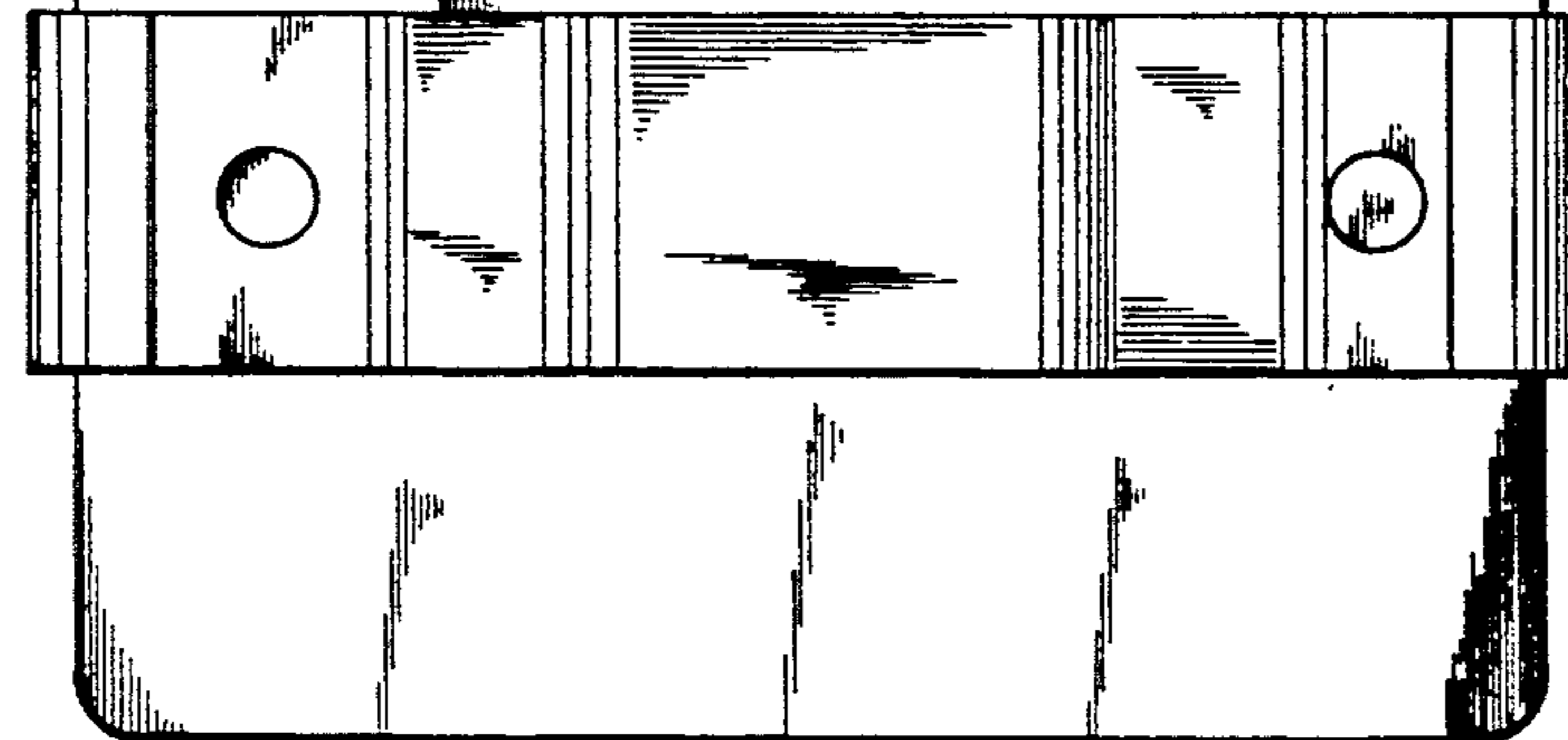

Fig. 3

