



US00D328367S

United States Patent [19]

Ishibashi et al.

[11] Patent Number: **Des. 328,367**

[45] Date of Patent: **** Jul. 28, 1992**

[54] ELECTRIC SHAVER

[75] Inventors: **Atsushi Ishibashi, Koganei; Atsuhiko Urushihara, Kokubunji; Toshiyuki Moriya, Tokorozawa, all of Japan**

[73] Assignee: **Kyushu Hitachi Maxell, Ltd., Fukuoka, Japan**

[**] Term: **14 Years**

[21] Appl. No.: **539,672**

[22] Filed: **Jun. 18, 1990**

[30] Foreign Application Priority Data

Jan. 6, 1990 [JP]	Japan	2-40
[52] U.S. Cl.		D28/49
[58] Field of Search		D28/44-54, D28/10; 30/32, 34.05, 34.1, 41, 42, 43, 44, 45, 43.1-43.6, 85, 86

[56] References Cited

U.S. PATENT DOCUMENTS

D. 258,993	4/1981	Ullmann	D28/49
D. 305,159	12/1989	Ullmann	D28/51 X
D. 306,497	3/1990	Higa et al.	D28/49
D. 319,514	8/1991	Elkerbout	D28/10
4,845,847	7/1989	Yasunaka et al.	30/34.1
4,941,259	7/1990	Wolf	30/43.1 X

FOREIGN PATENT DOCUMENTS

2843947	3/1980	Fed. Rep. of Germany	30/34.1
3509184	9/1986	Fed. Rep. of Germany	30/34.1
2267678	11/1975	France	30/90

Primary Examiner—Bernard Ansher
Assistant Examiner—C. Tuttle
Attorney, Agent, or Firm—Birch, Stewart, Kolasch & Birch

[57] CLAIM

The ornamental design for an electric shaver, as shown and described.

DESCRIPTION

FIG. 1 is a front elevational view of an electric shaver showing our new design;
 FIG. 2 is a right side elevational view thereof;
 FIG. 3 is a left side elevational view thereof;
 FIG. 4 is a rear elevational view thereof;
 FIG. 5 is a cross sectional view taken on line 5—5 of FIG. 1;
 FIG. 6 is a top plan view thereof;
 FIG. 7 is a bottom plan view thereof;
 FIG. 8 is a cross-sectional view taken on line 8—8 of FIG. 1;
 FIG. 9 is a cross-sectional view taken on line 9—9 of FIG. 1;
 FIG. 10 is a top rear perspective view showing the plug element extended, and the various movable elements in alternate positions; and,
 FIG. 11 is a top front perspective view shown with the operating switch in an alternate position.

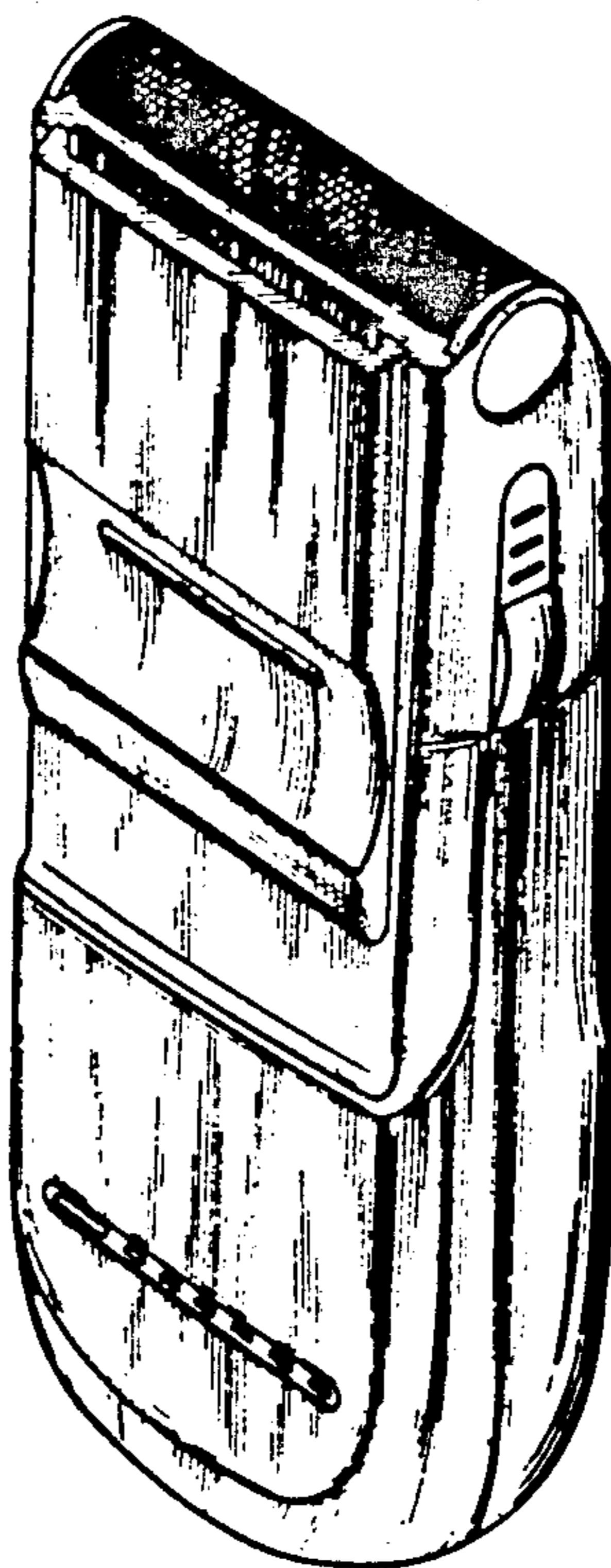

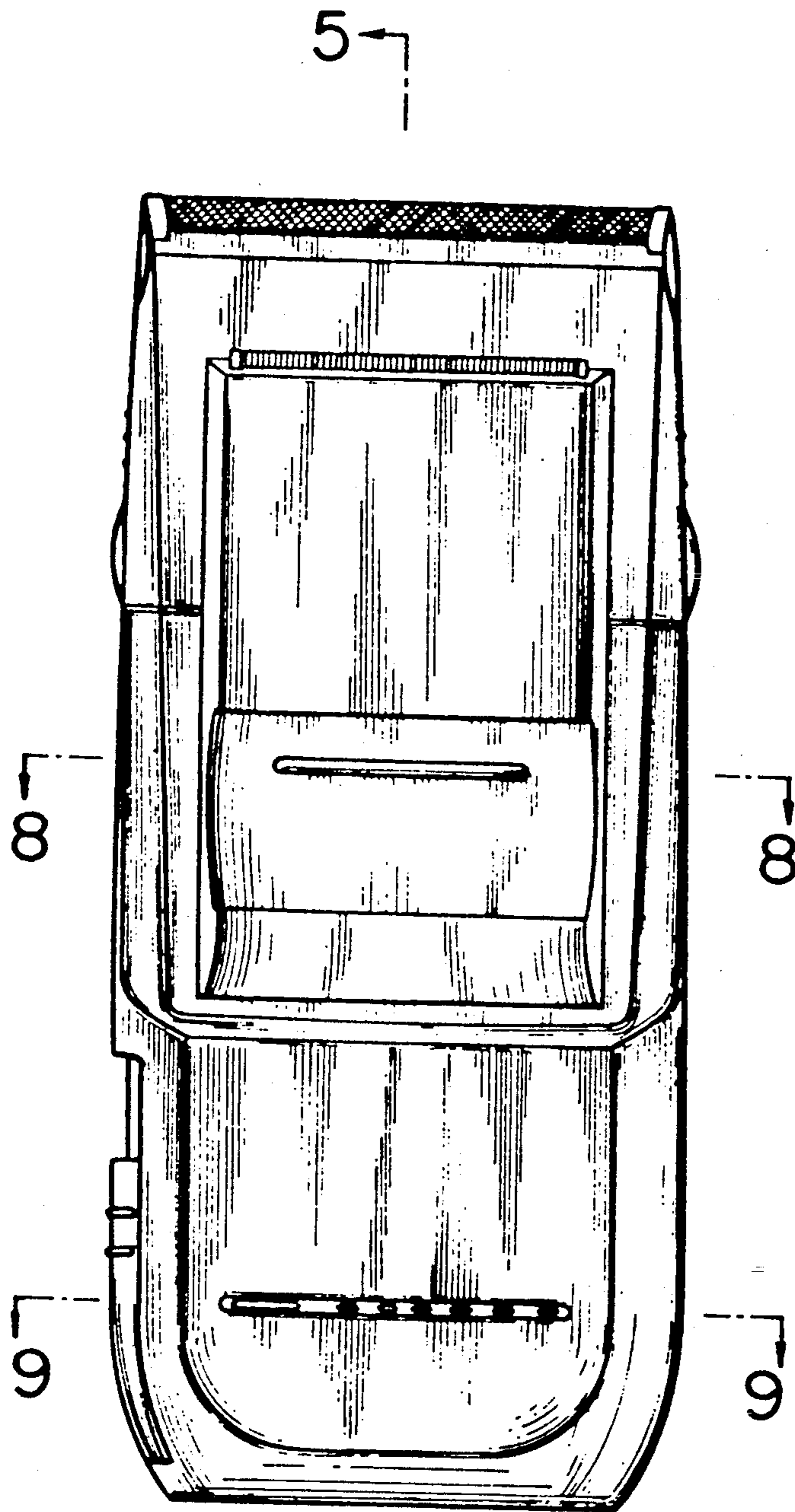

FIG. 1

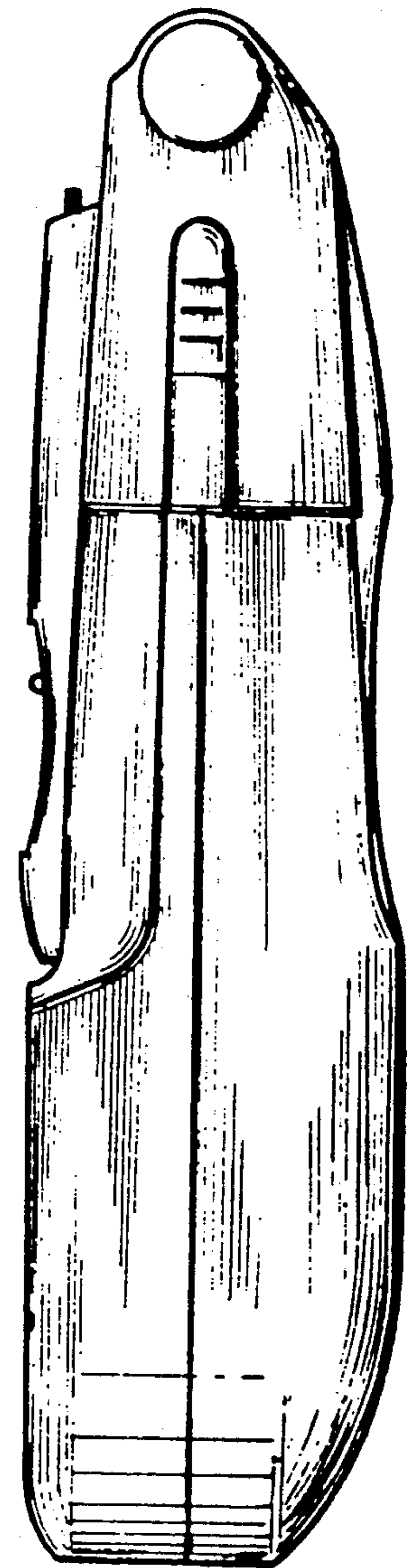

FIG. 2

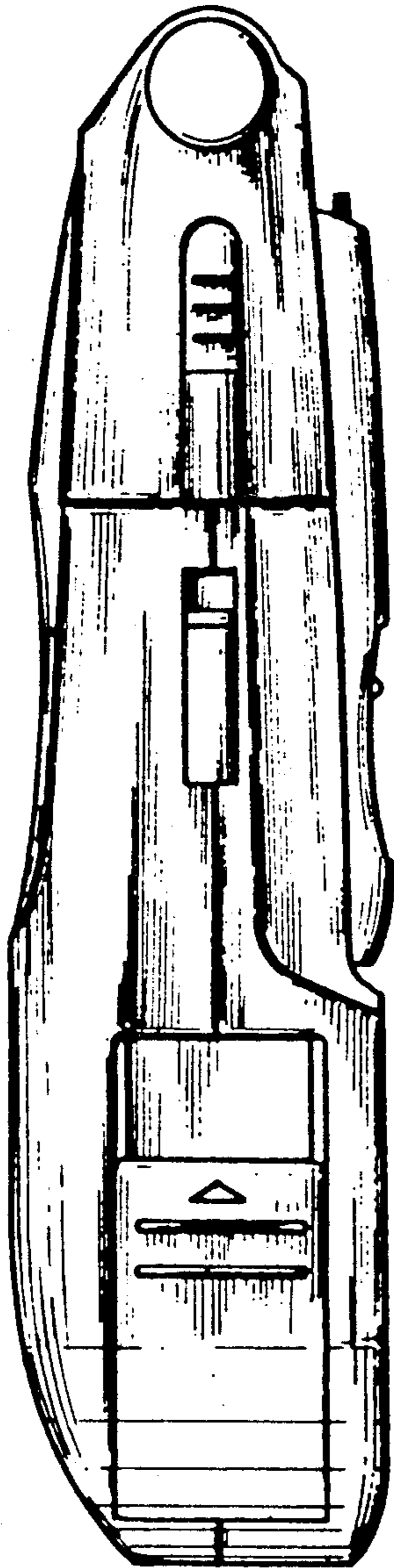

FIG. 3

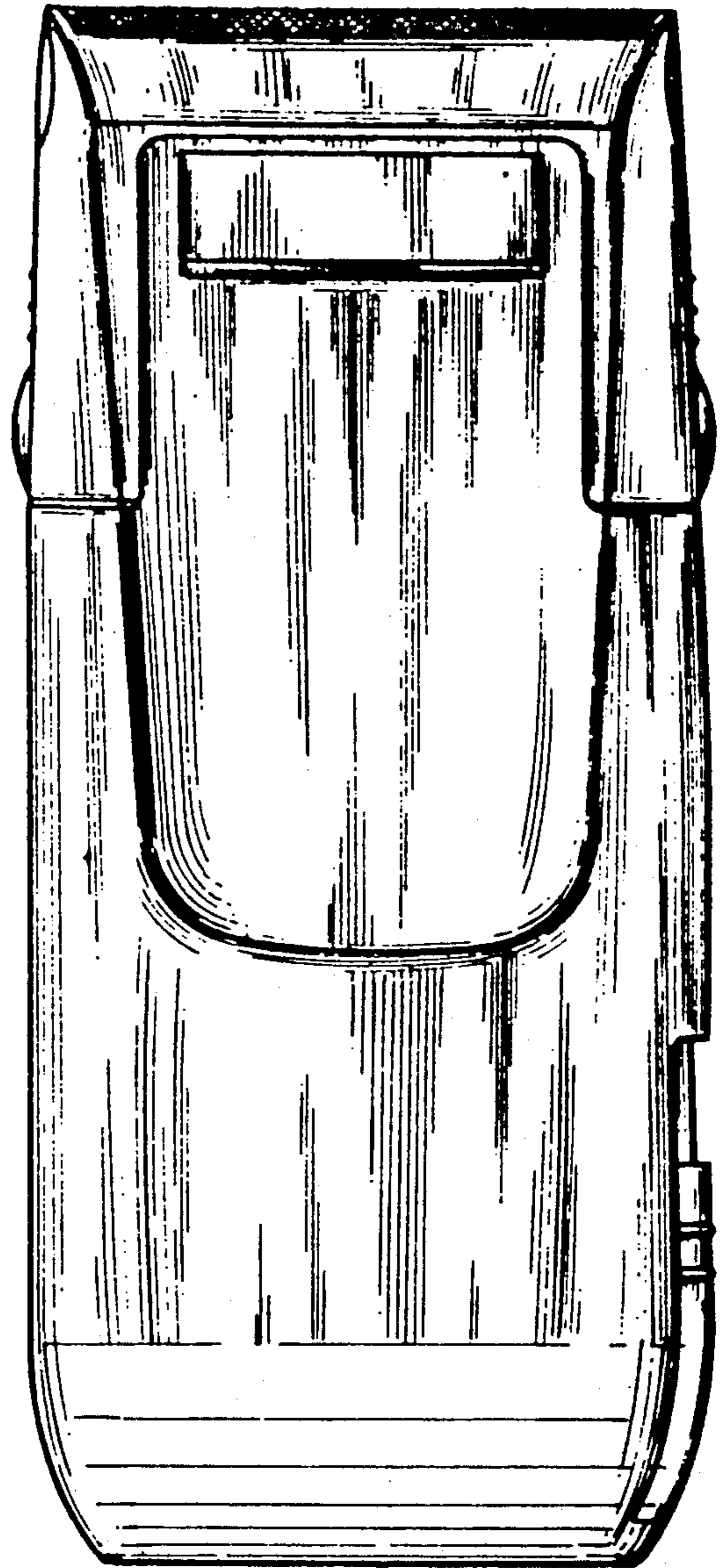

FIG. 4

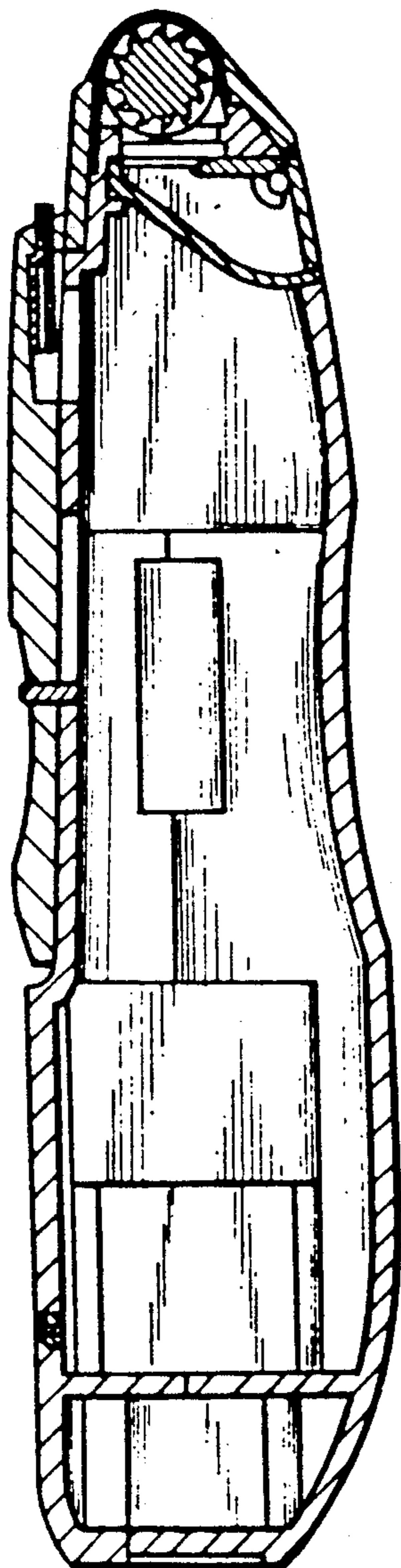

FIG. 5

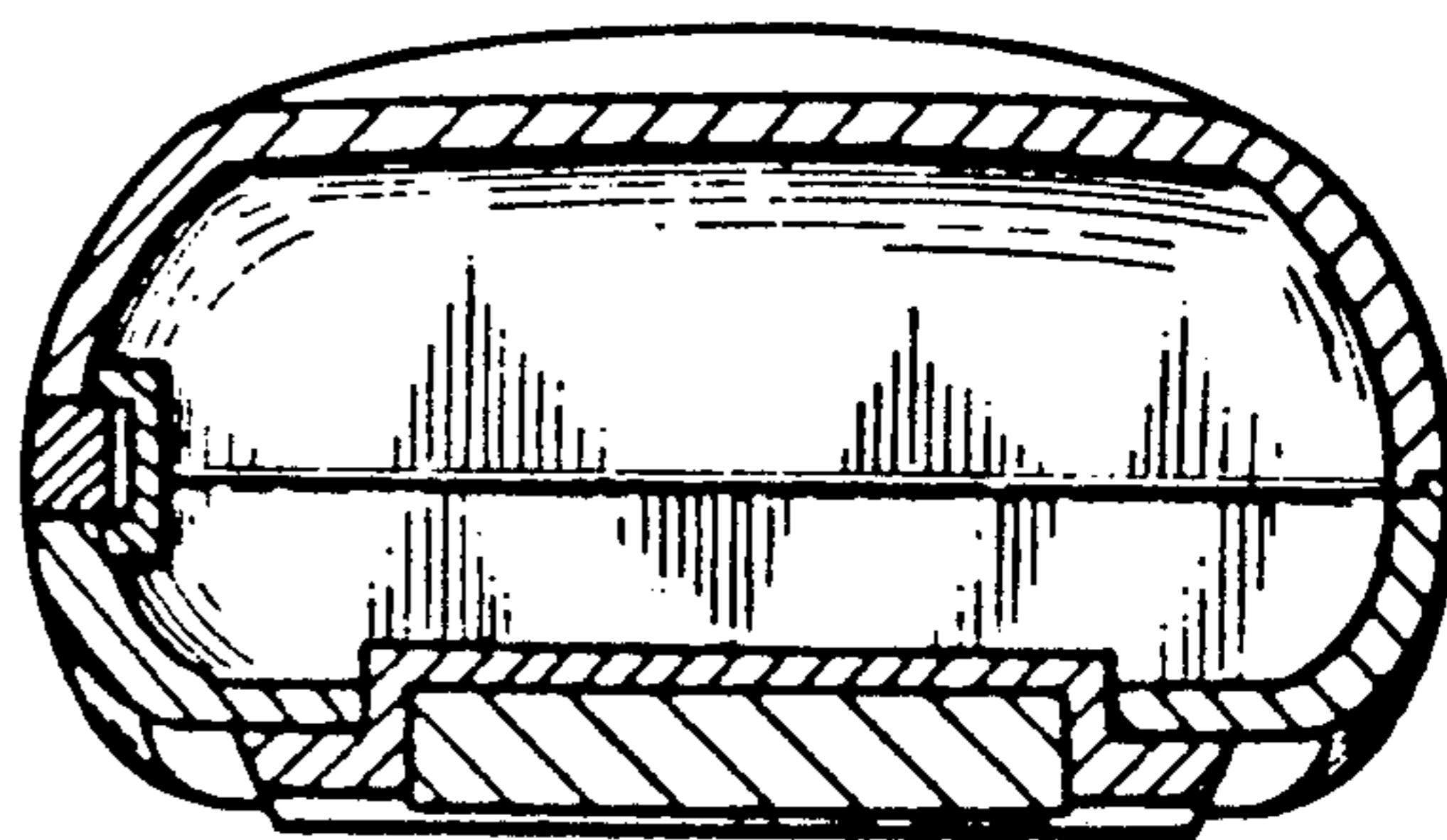

FIG. 8

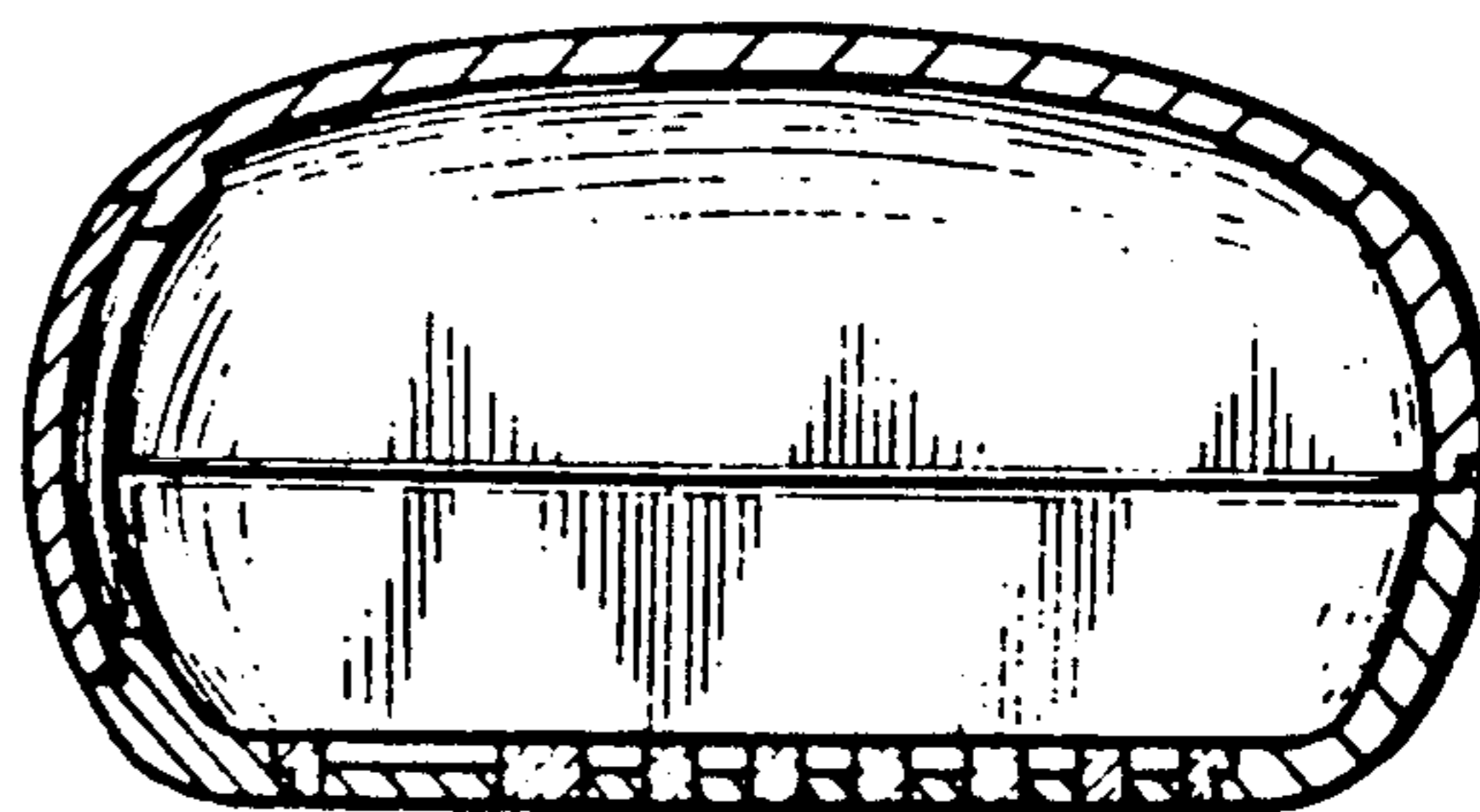

FIG. 9

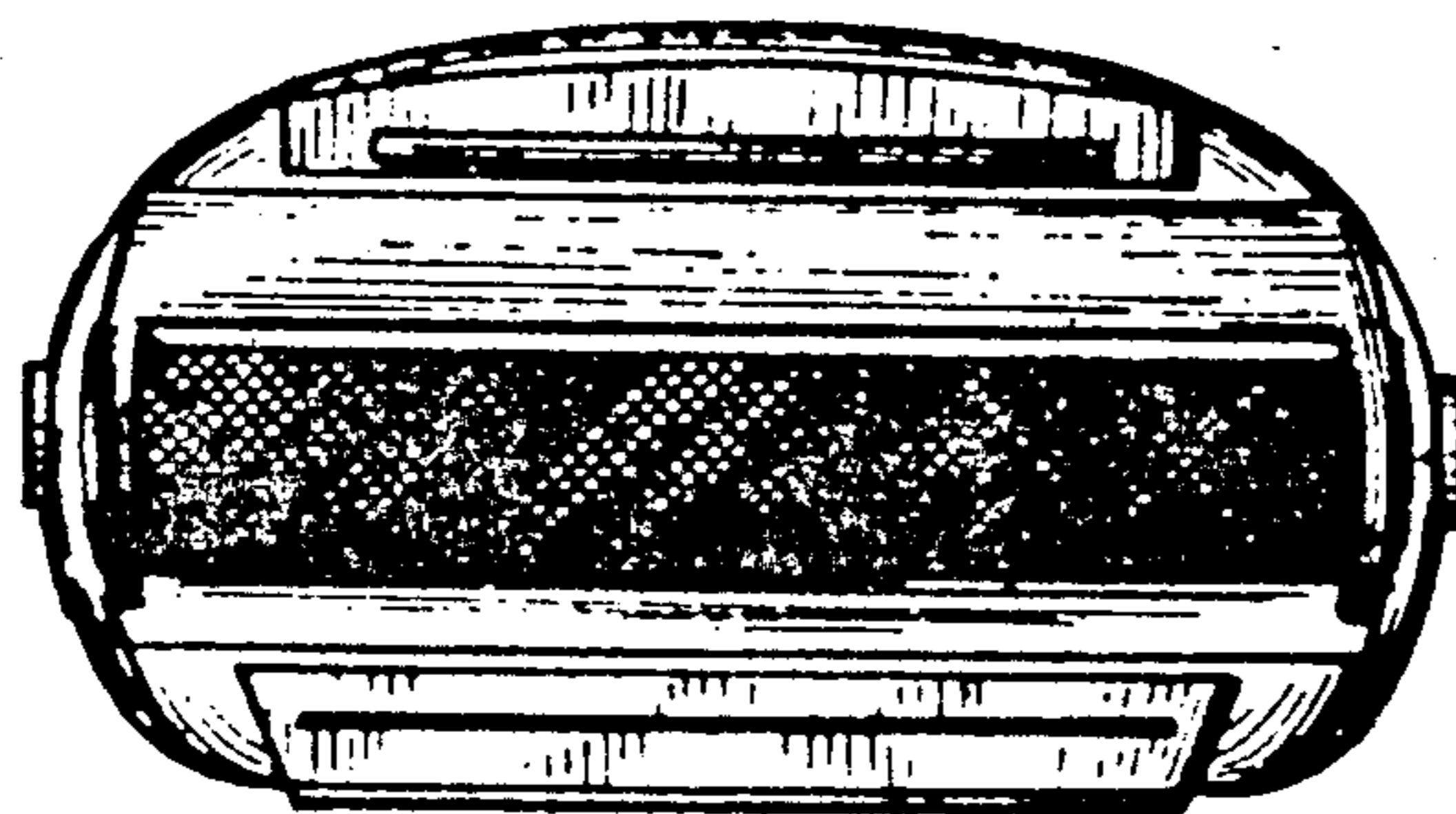

FIG. 6

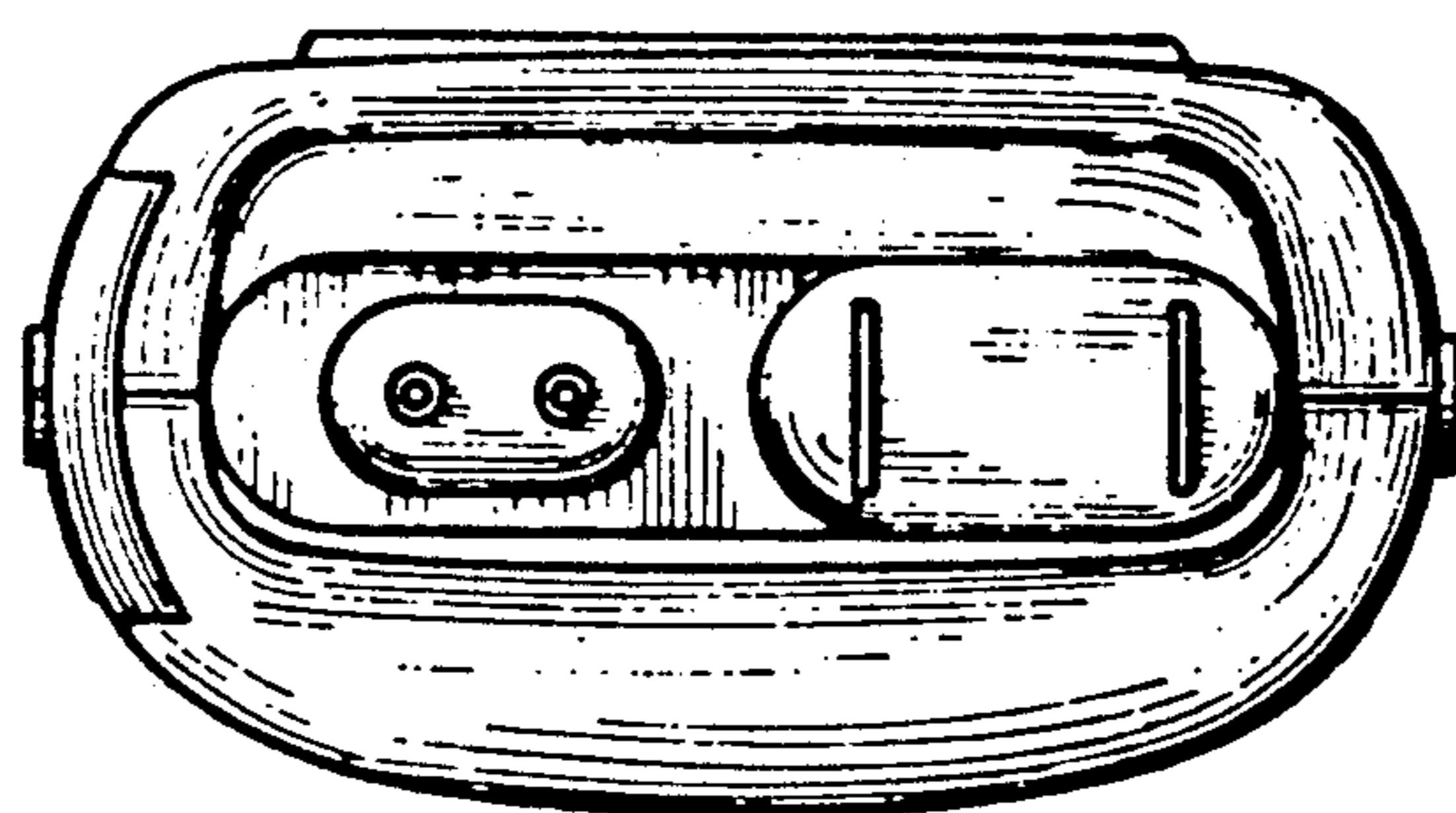

FIG. 7

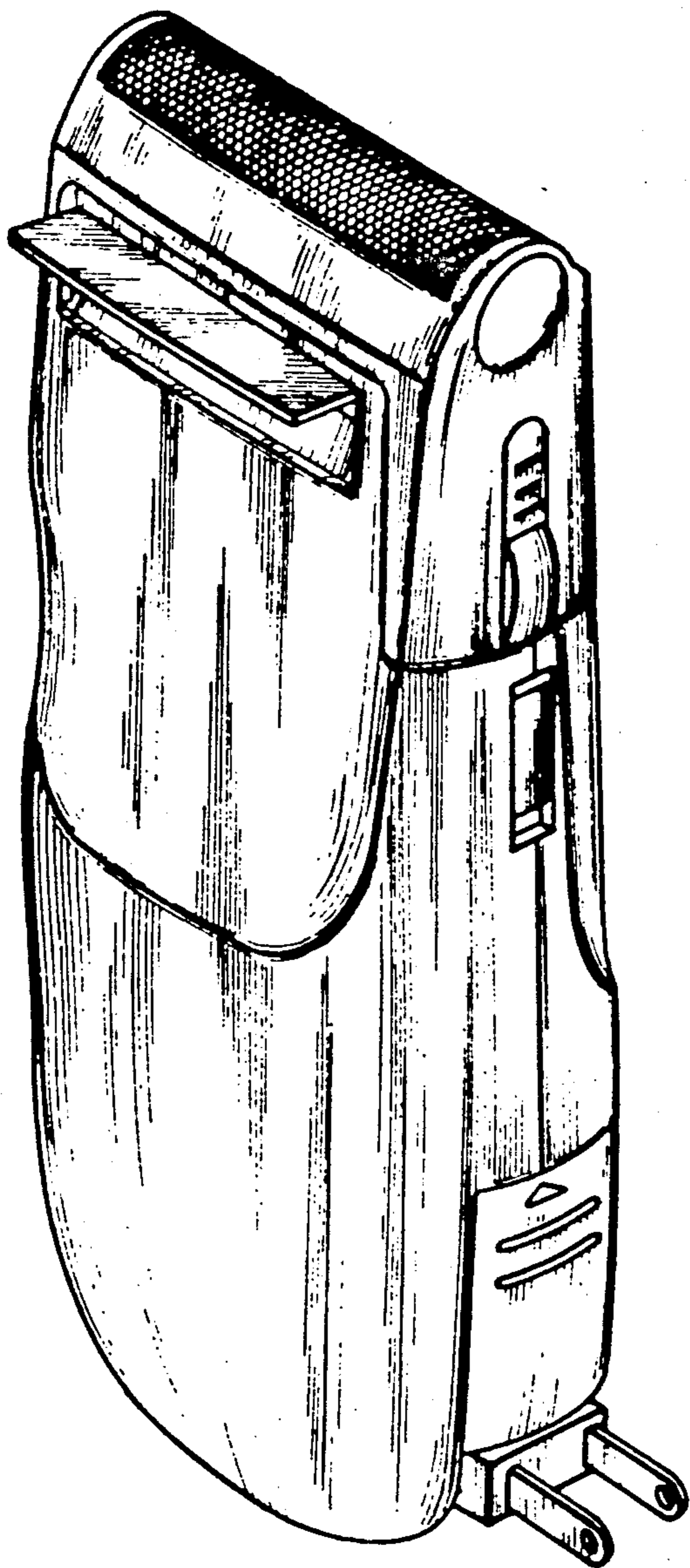

FIG. 10

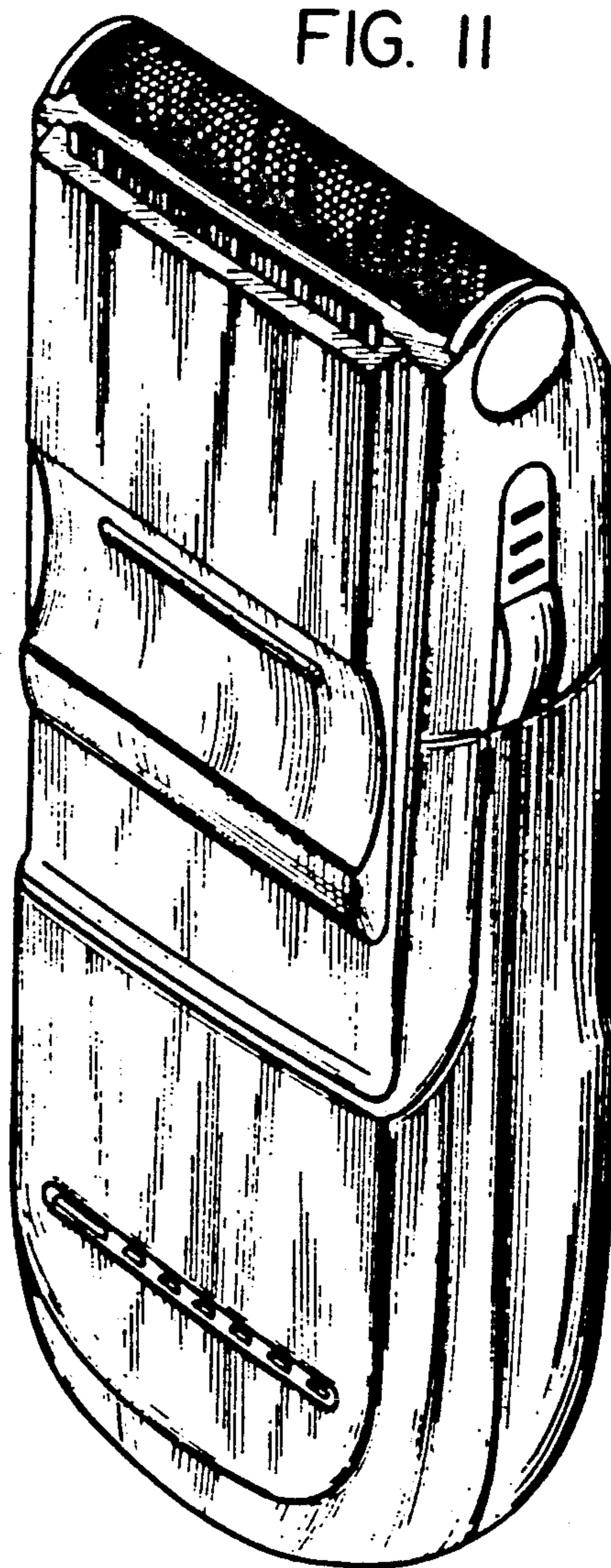

FIG. 11