



US00D328221S

**United States Patent** [19]  
**Piccarillo**

[11] **Patent Number: Des. 328,221**  
[45] **Date of Patent: \*\* Jul. 28, 1992**

[54] **WHEELED COOLER CHEST**  
[76] **Inventor: Joseph Piccarillo, 1921 - 80th St.,  
Brooklyn, N.Y. 11213**  
[\*\*] **Term: 14 Years**  
[21] **Appl. No.: 527,243**  
[22] **Filed: May 23, 1990**  
[52] **U.S. Cl. .... D7/605**  
[58] **Field of Search ..... D7/605-608;  
D34/12, 14, 24; 206/541, 545; 62/457.1, 457.2,  
457.7**

4,873,841 10/1989 Bradsaw et al. .... 62/457.1 X  
4,932,677 6/1990 Shustack ..... 62/457.1 X

*Primary Examiner—Terry A. Pfeffer*  
*Attorney, Agent, or Firm—Terry M. Gernstein*

[57] **CLAIM**

The ornamental design for a wheeled cooler chest, as shown and described.

**DESCRIPTION**

FIG. 1 is a perspective view of a wheeled cooler chest showing my new design;  
FIG. 2 is a left side elevational view thereof;  
FIG. 3 is a front elevational view thereof;  
FIG. 4 is a right side elevational view thereof;  
FIG. 5 is a rear elevational view thereof;  
FIG. 6 is a top plan view thereof; and,  
FIG. 7 is a bottom view thereof.

[56] **References Cited**  
**U.S. PATENT DOCUMENTS**

3,591,194 7/1971 Vaga .  
4,319,629 3/1982 Hotta .  
4,724,681 2/1988 Bartholomew .

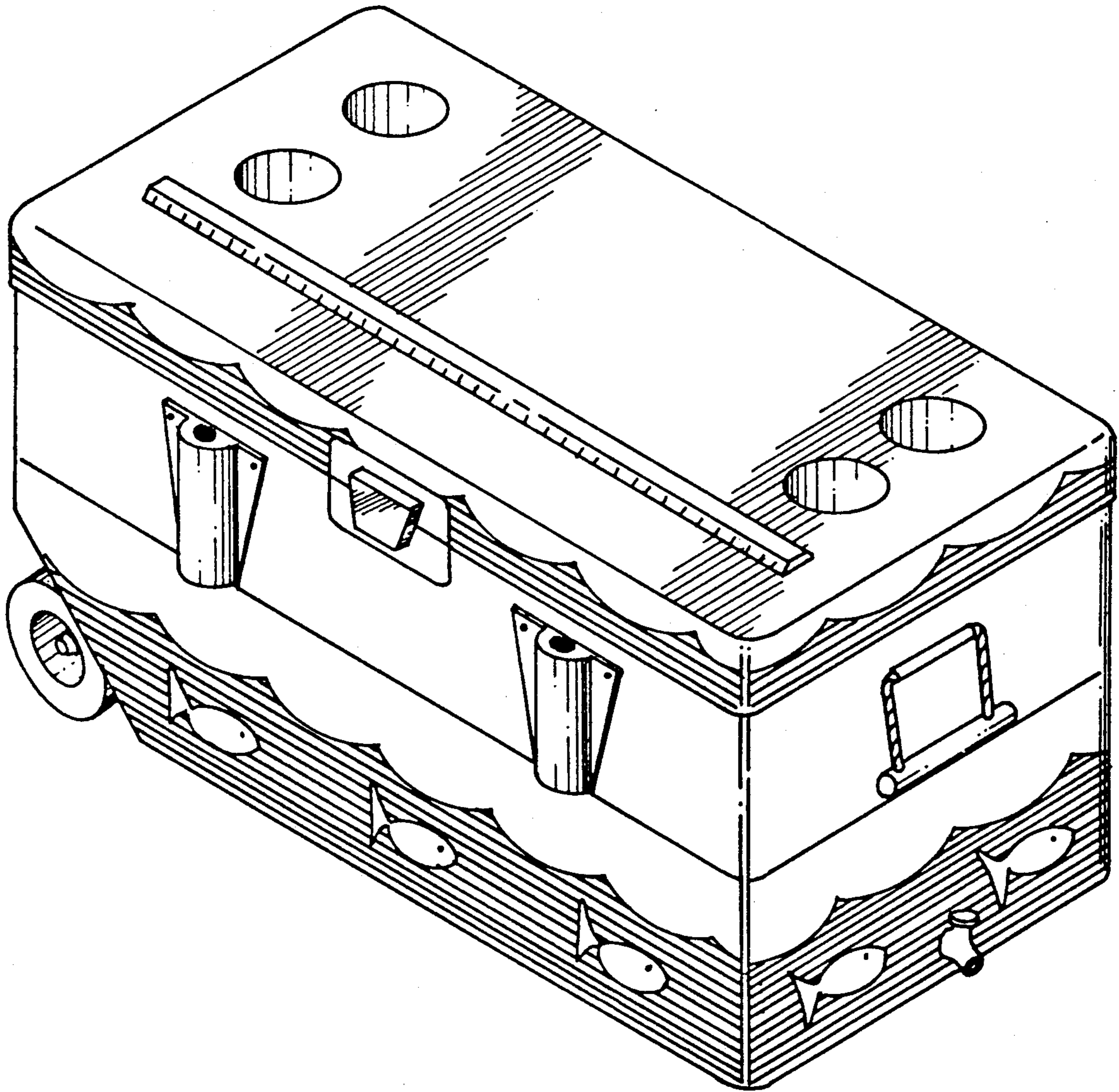

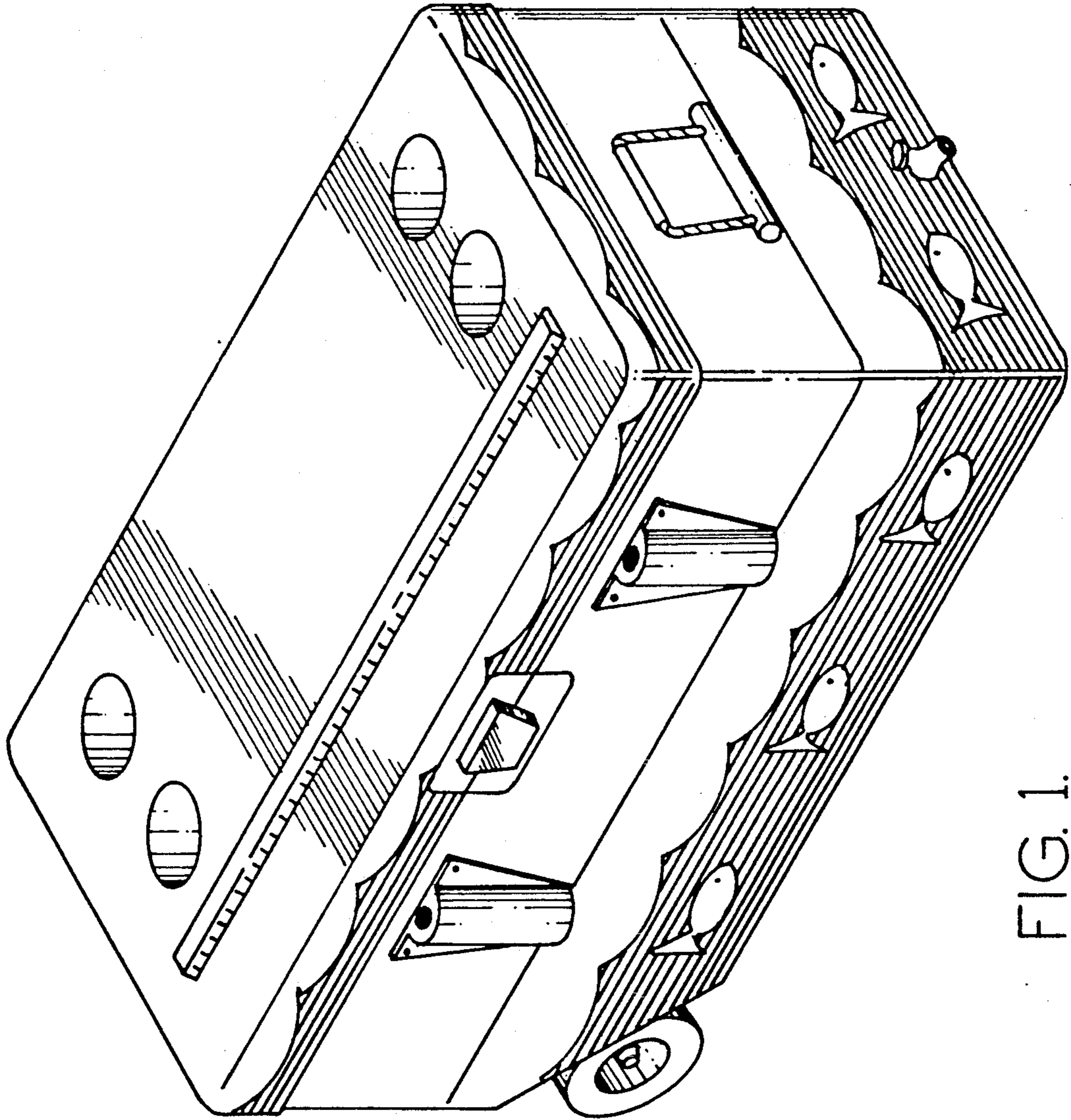

FIG. 1.

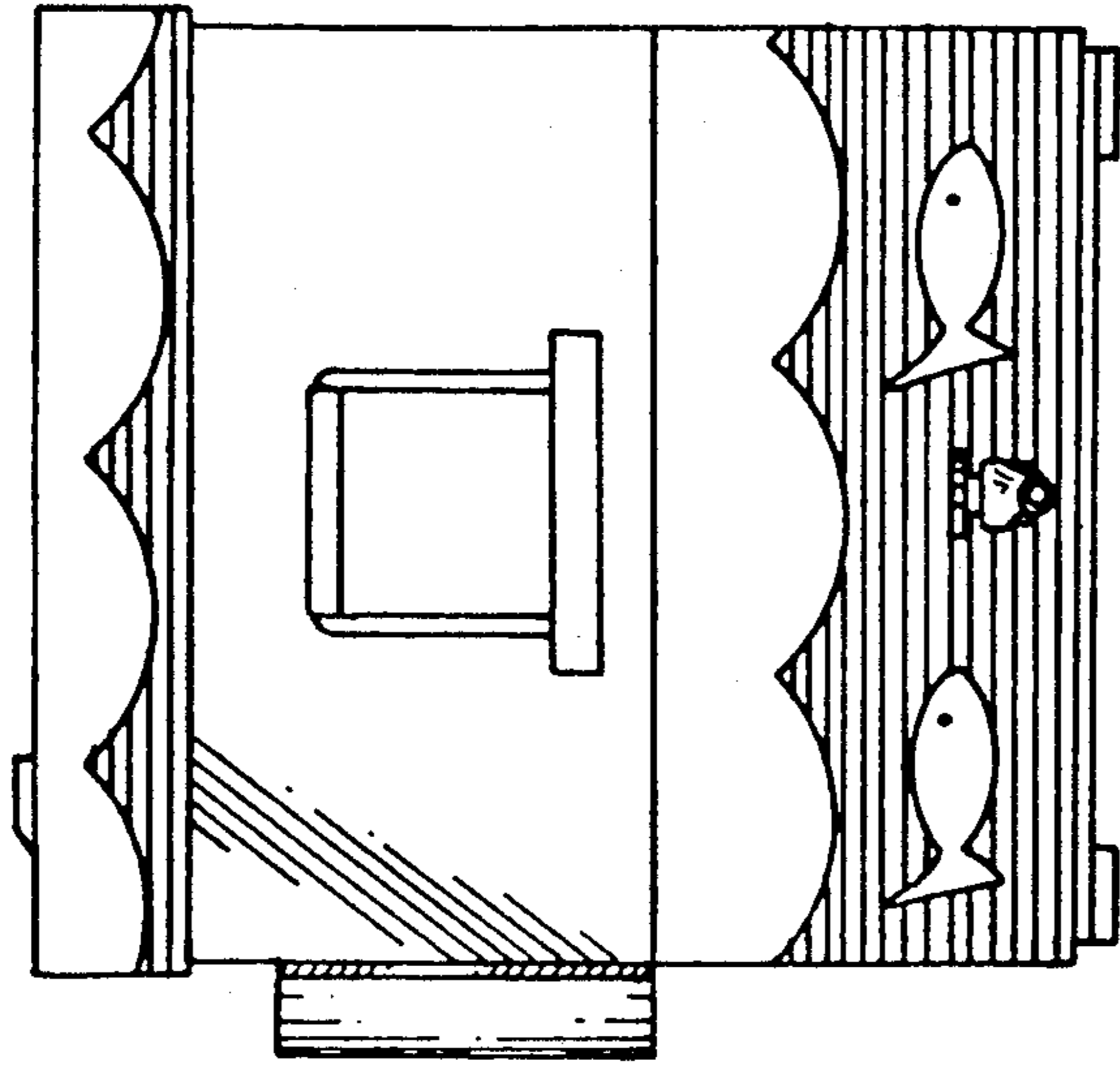

FIG. 2.

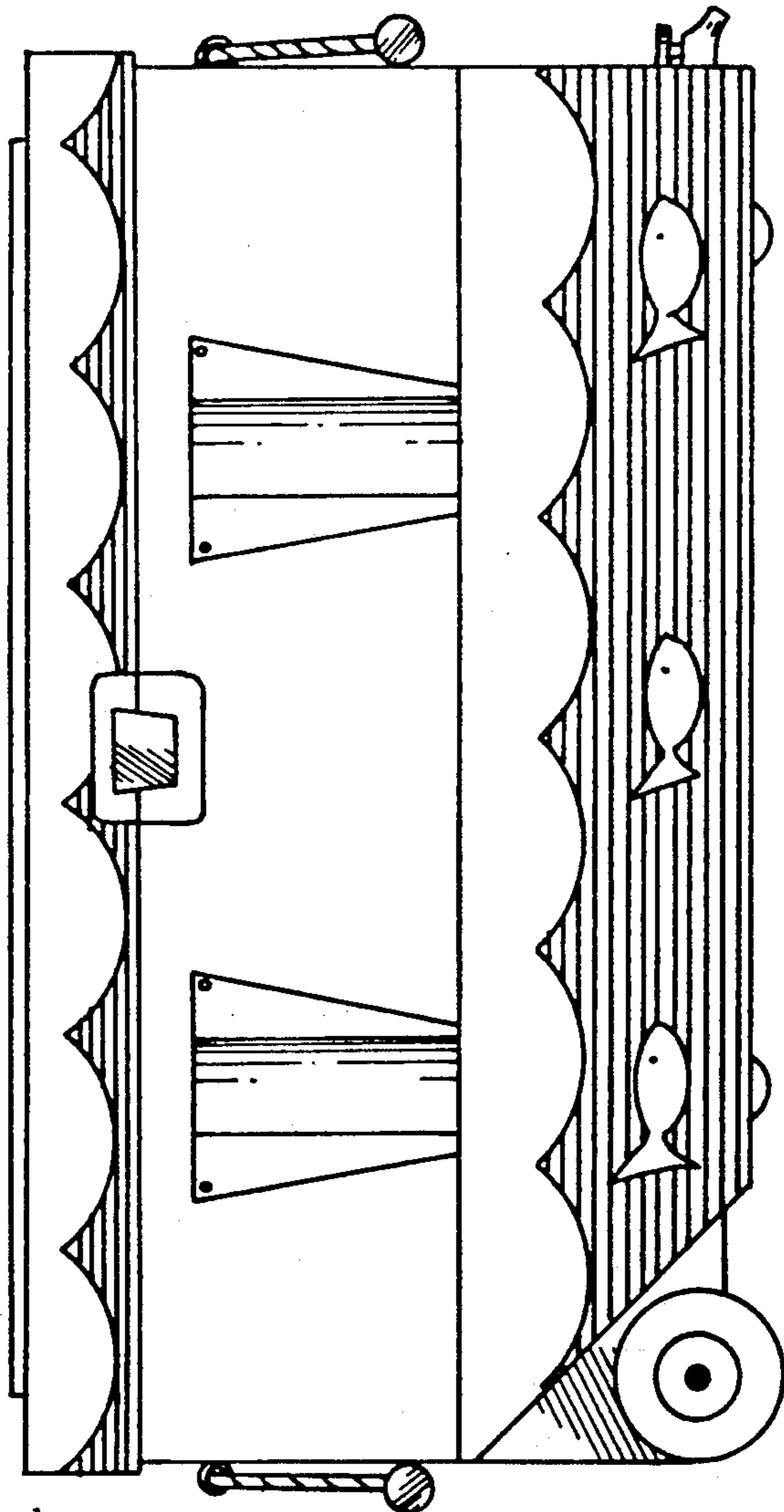

FIG. 3.

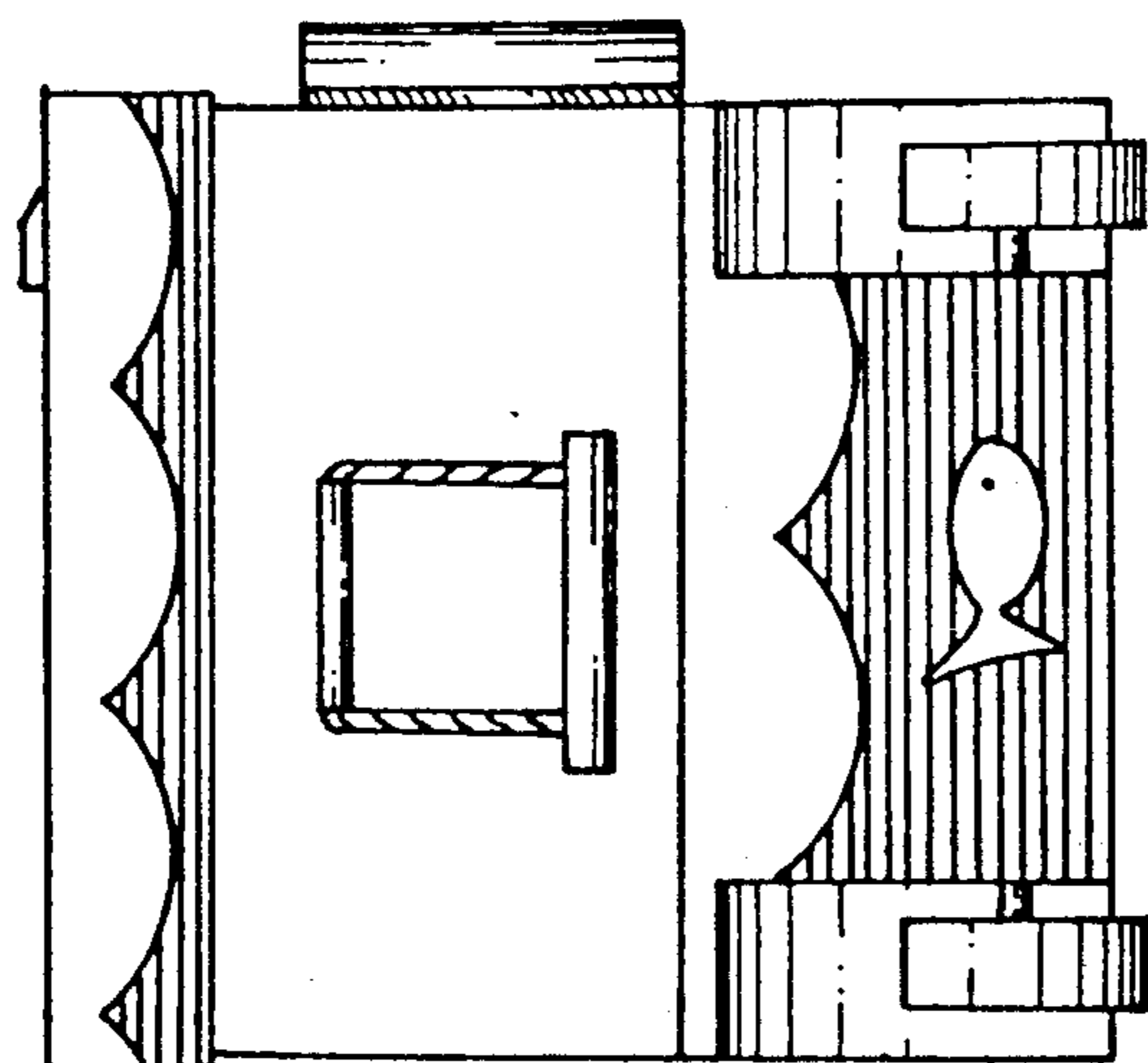

FIG. 5.

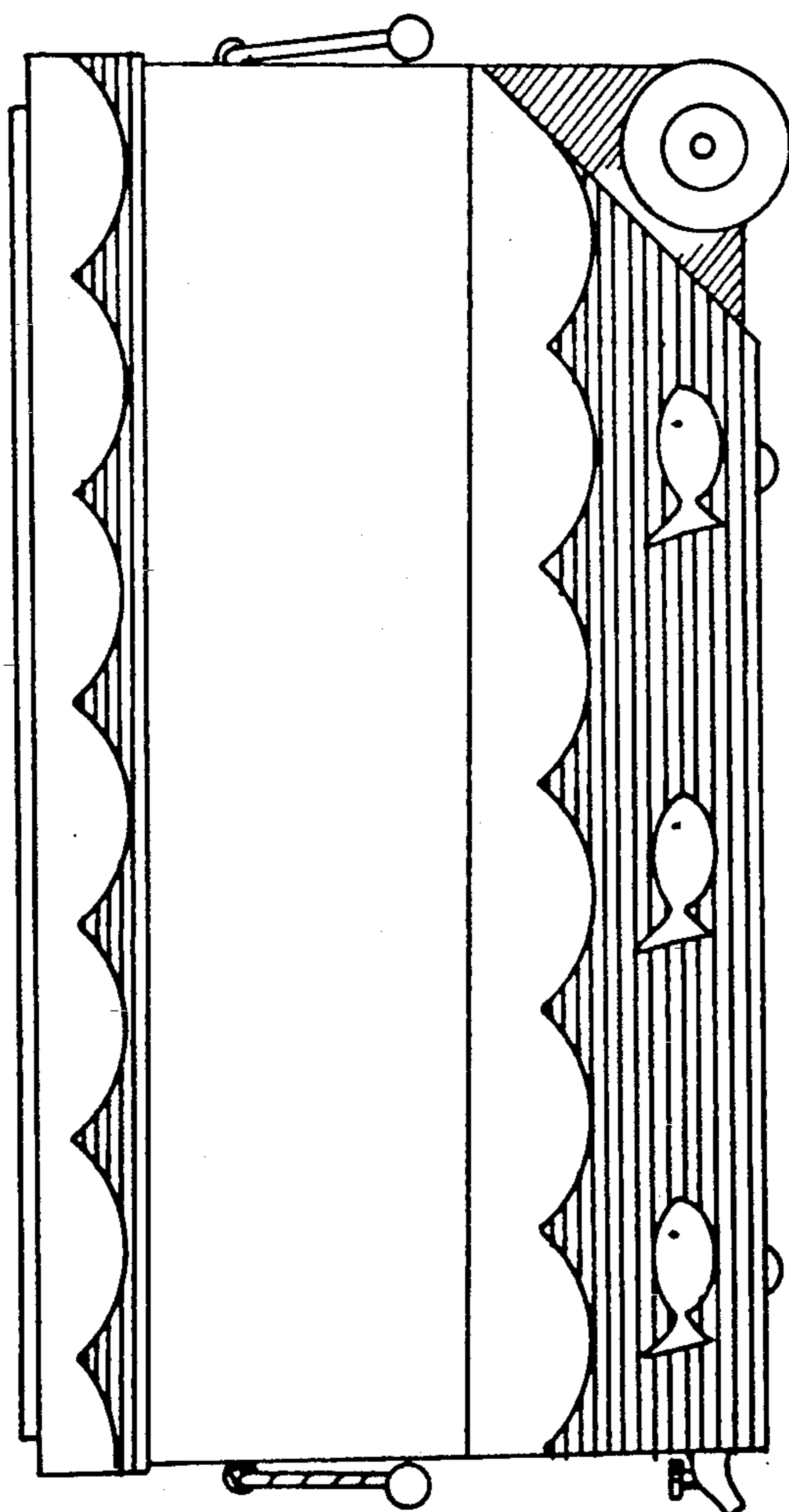

FIG. 4.

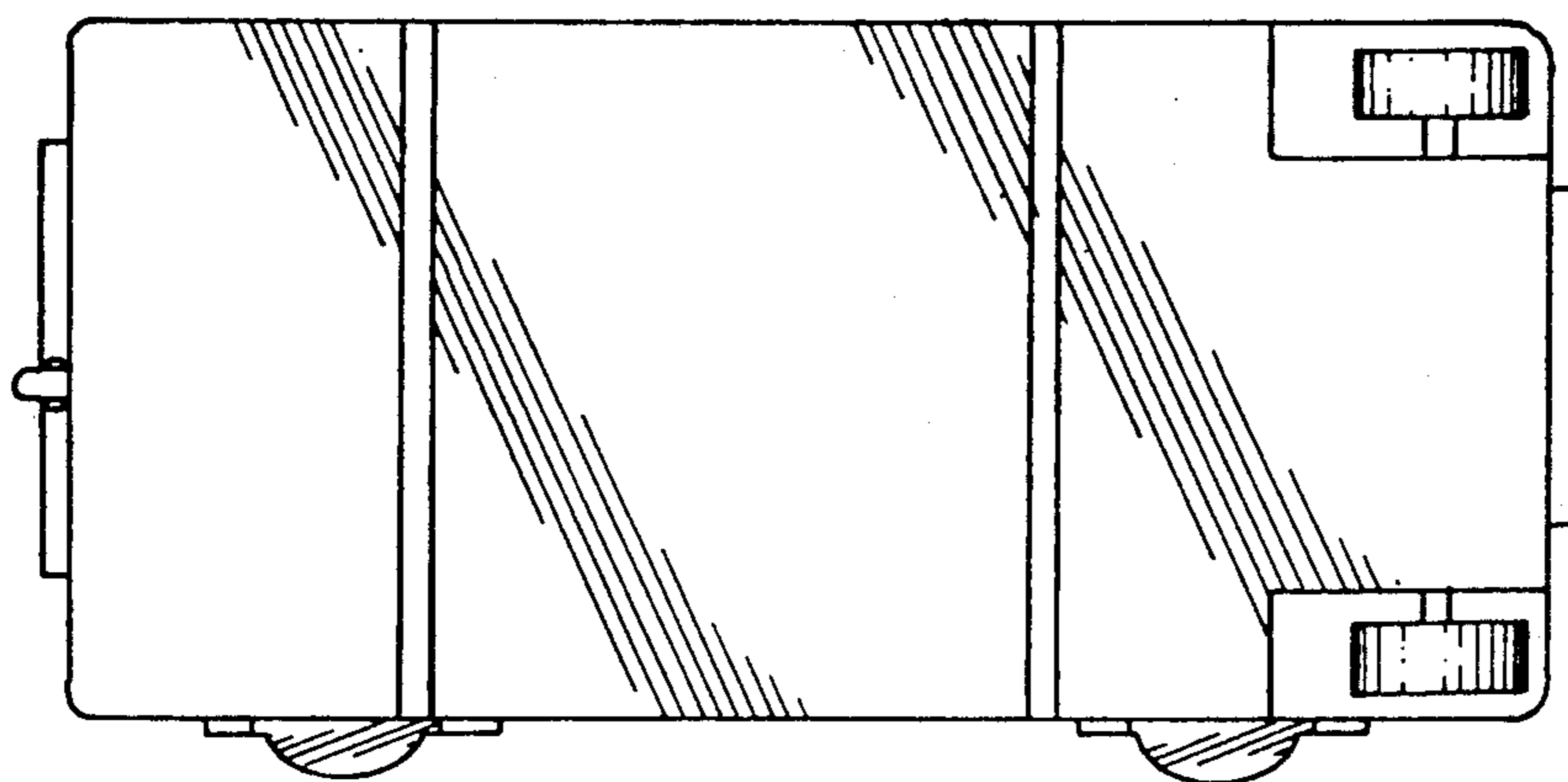

FIG.7.

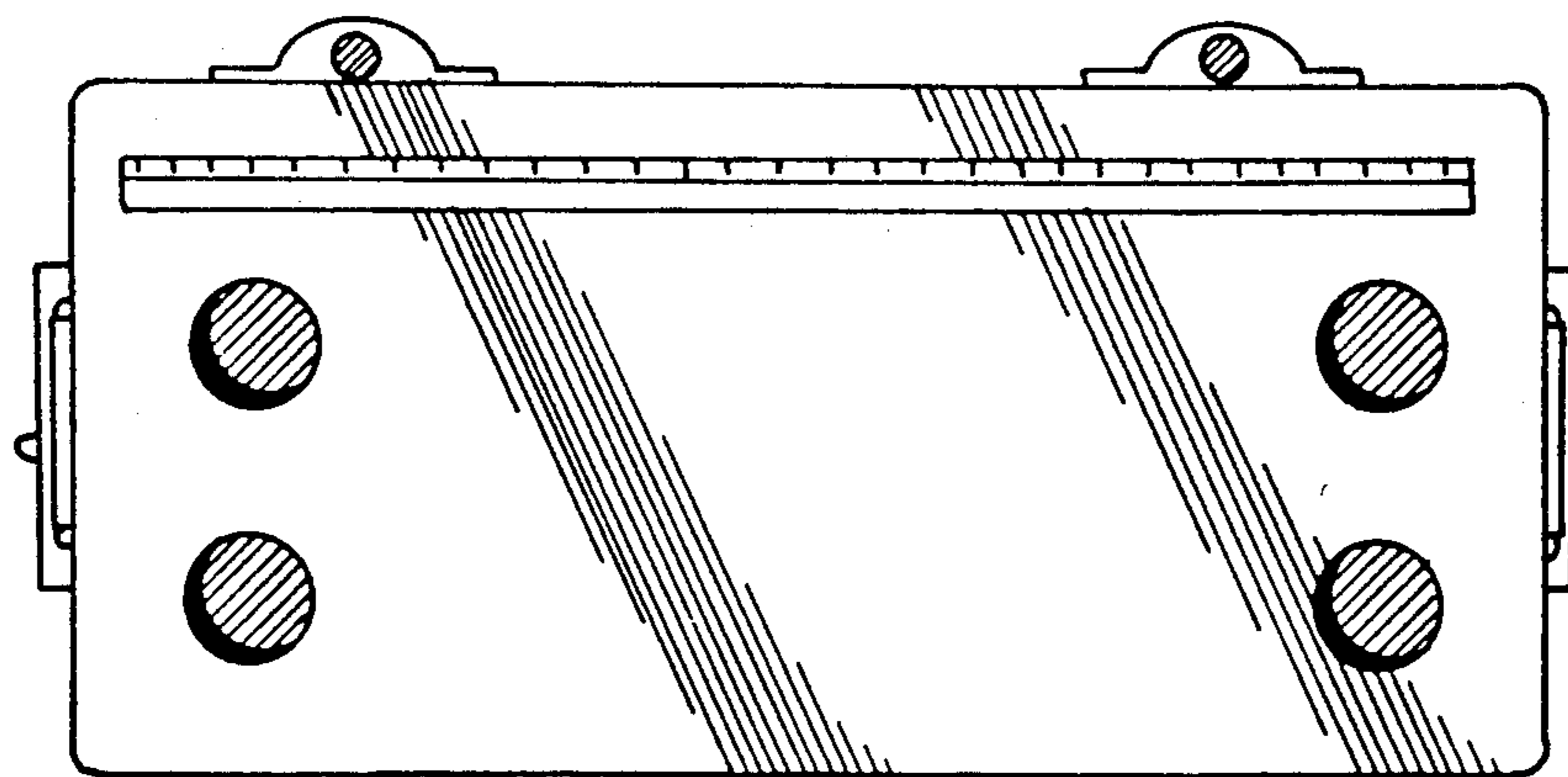

FIG.6.