



US00D328220S

# United States Patent [19]

[11] Patent Number: **Des. 328,220**

Barnard et al.

[45] Date of Patent: **\*\* Jul. 28, 1992**

## [54] FLUID FOOD DISPENSER

[75] Inventors: **Frank P. Barnard**, Olmsted Township, Cuyahoga County; **Sreenivasan Sankar**, Middleburg Heights, both of Ohio

[73] Assignee: **Vita-Mix Corporation**, Cleveland, Ohio

[\*\*] Term: **14 Years**

[21] Appl. No.: **564,309**

[22] Filed: **Aug. 8, 1990**

[52] U.S. Cl. .... **D7/589; D7/313**

[58] Field of Search ..... **D7/589, 300, 311-313; 222/105, 129.1, 129.2, 181, 185**

## [56] References Cited

### U.S. PATENT DOCUMENTS

D. 200,894	4/1965	Sohn et al. ....	D7/589
D. 242,380	11/1976	Steuna et al. ....	D7/589
D. 282,617	2/1986	Hogan .....	D7/589
4,513,885	4/1985	Hogan .....	D7/589 X

## OTHER PUBLICATIONS

McCormick's Gardenfare System, 3 page brochure, McCormick & Co., Inc., Baltimore, Md 21202; 1980.  
Liqui-Box/b-Bar-B one page brochure, Liqui-Box Corporation, P.O. Box 494, Worthington, Ohio 43085; 1989.

*Primary Examiner*—Terry A. Pfeffer  
*Attorney, Agent, or Firm*—Renner, Kenner, Greive, Bobak, Taylor & Weber

## [57] CLAIM

The ornamental design for a fluid food dispenser, as shown and described.

## DESCRIPTION

FIG. 1 is a perspective view of a fluid food dispenser showing our new design;  
FIG. 2 is a right side elevational view thereof, the opposite being a mirror image;  
FIG. 3 is a front elevational view thereof;  
FIG. 4 is a rear elevational view thereof;  
FIG. 5 is a top plan view thereof; and,  
FIG. 6 is a bottom plan view thereof.

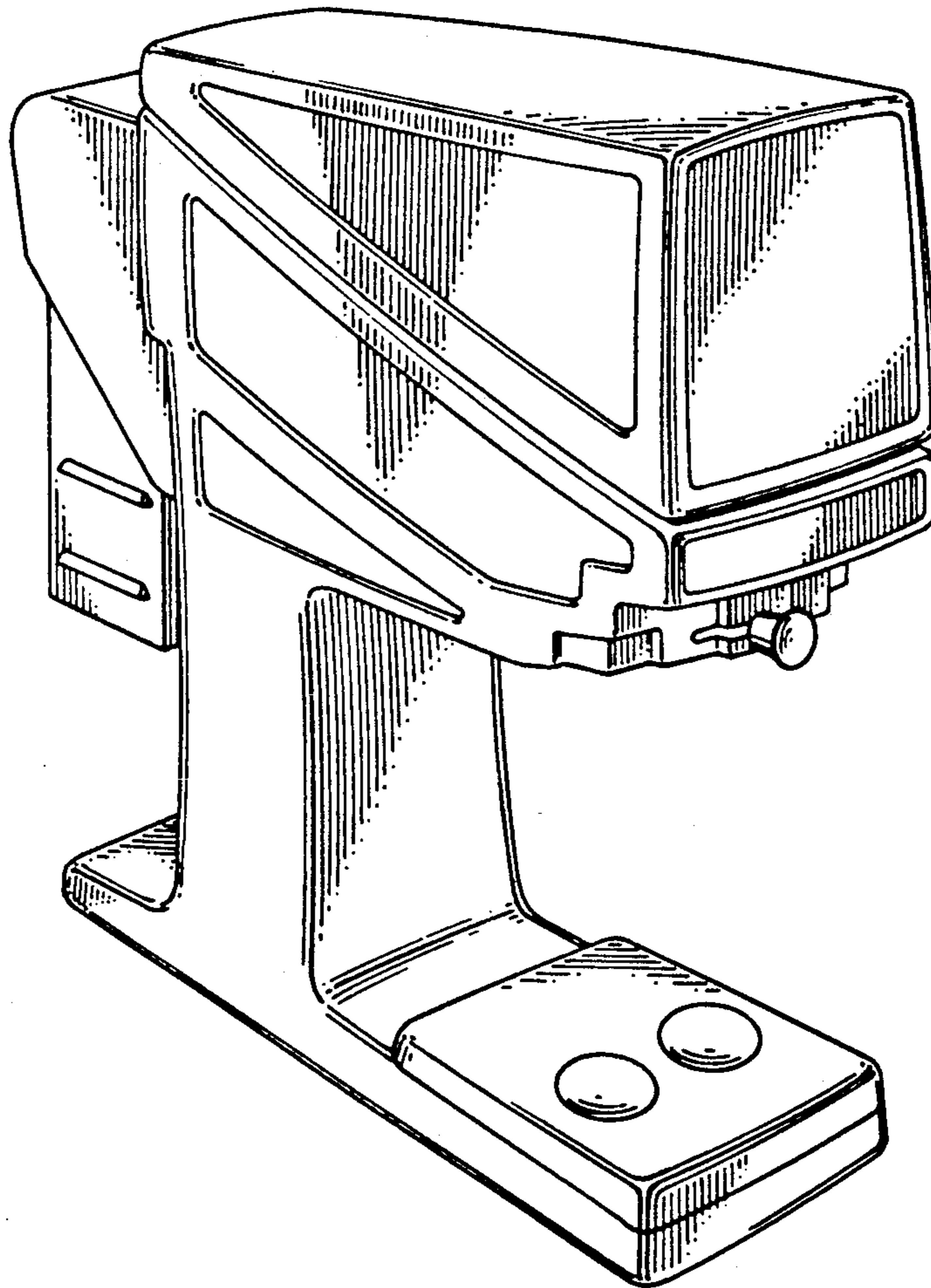

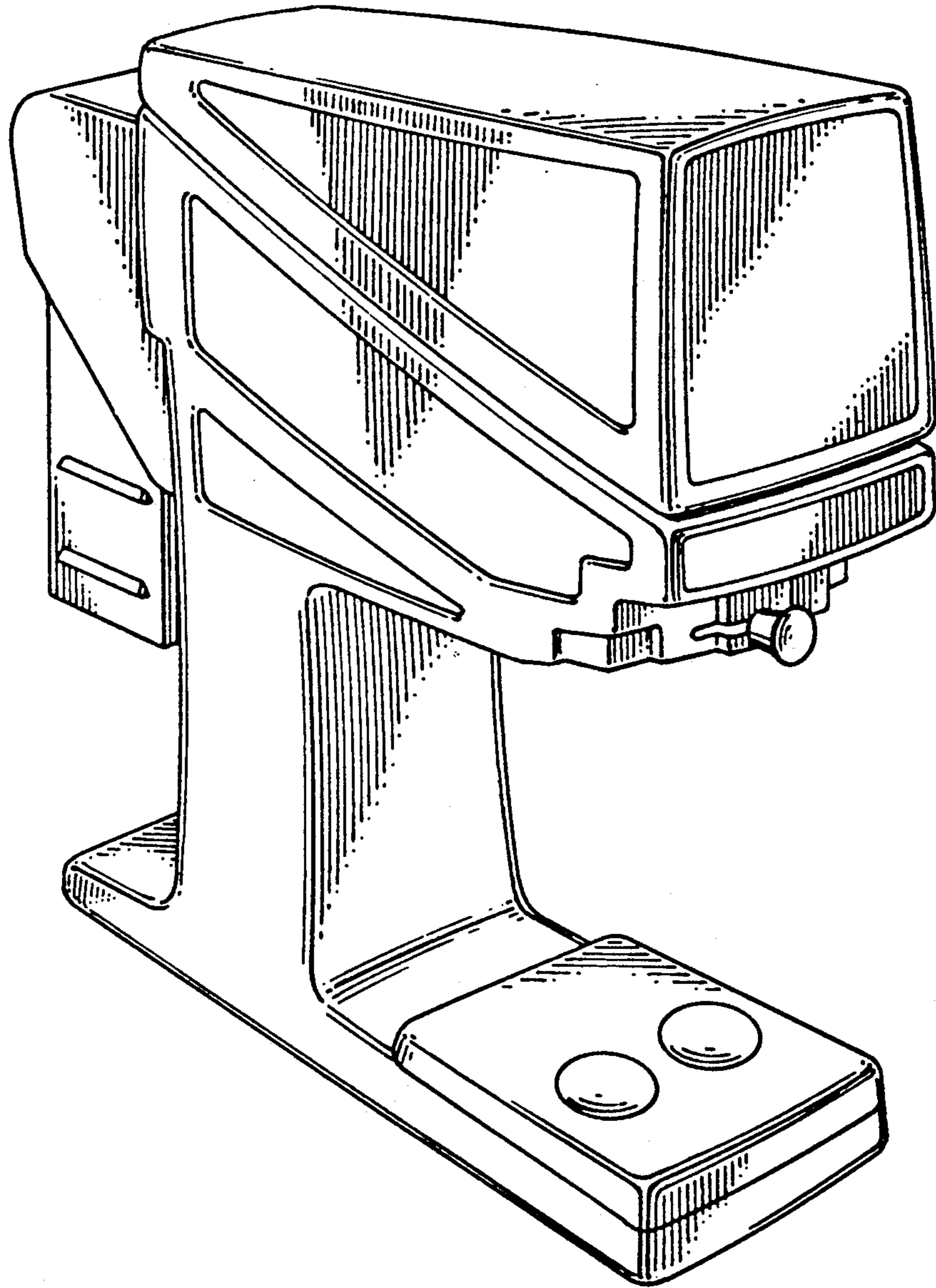

FIG. 1

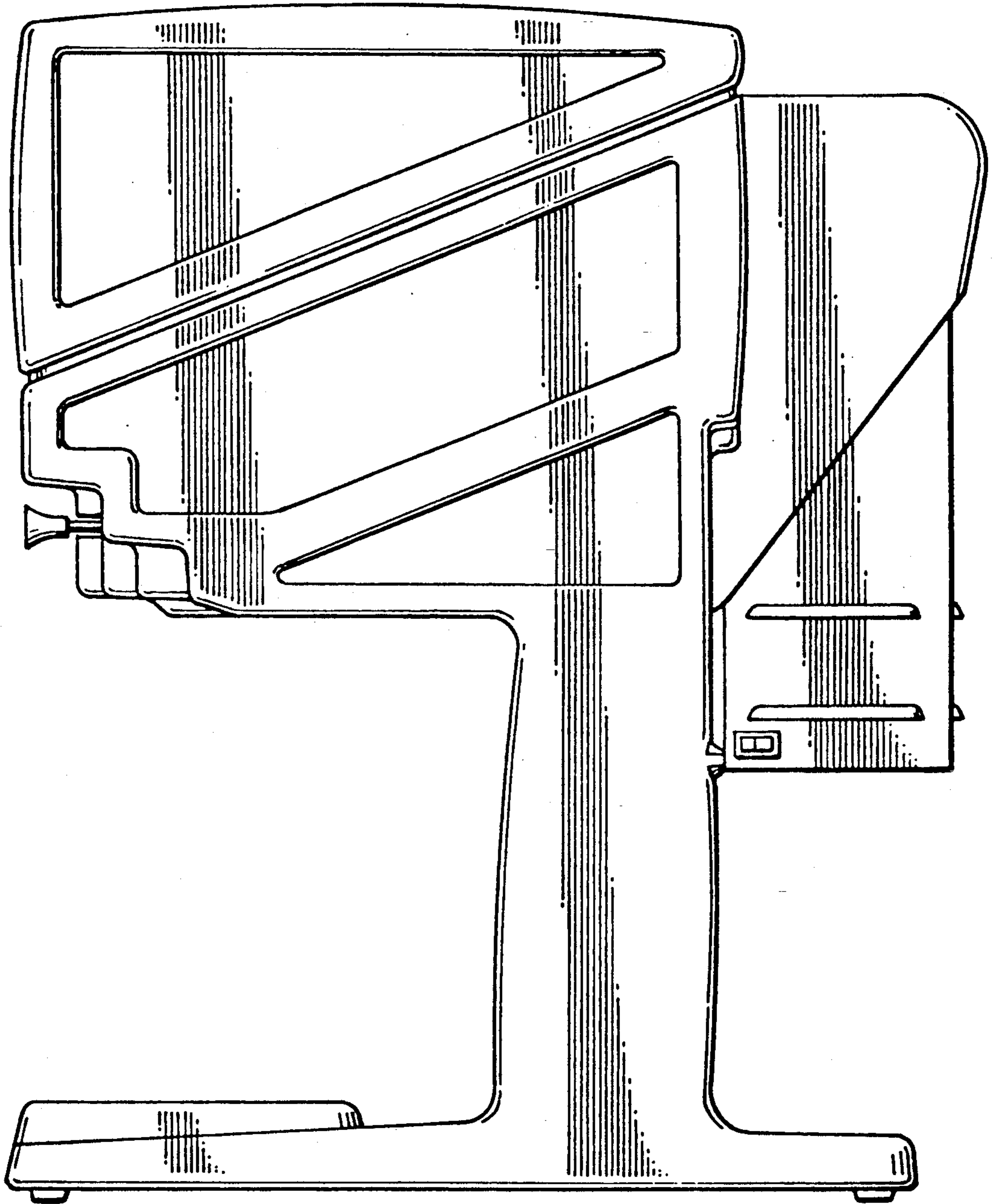

FIG. 2

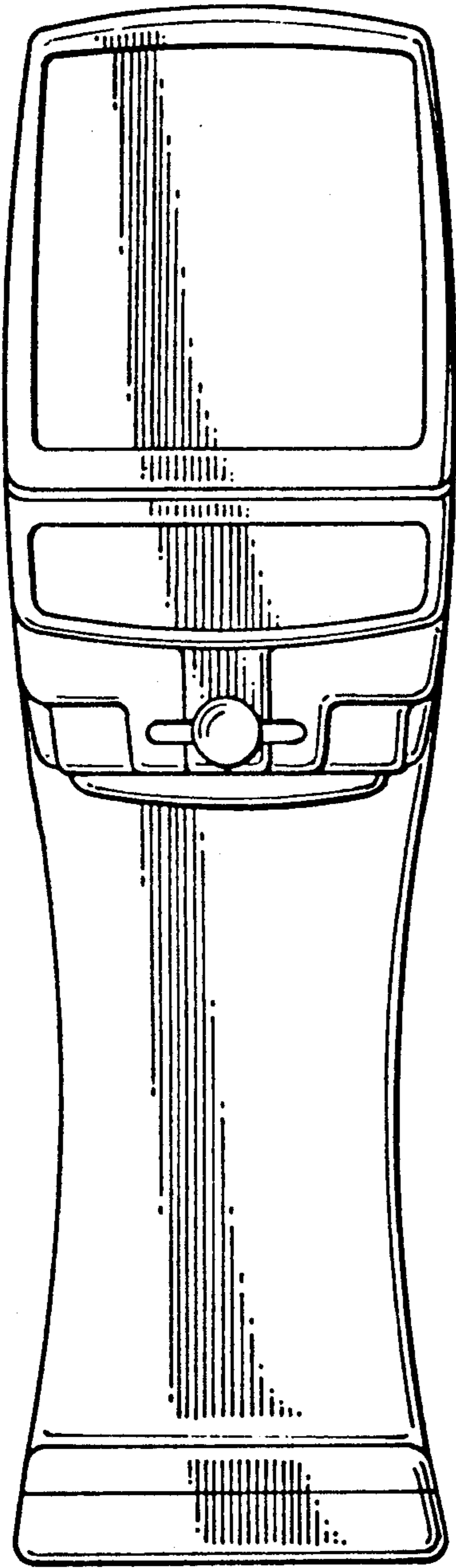

FIG. 3

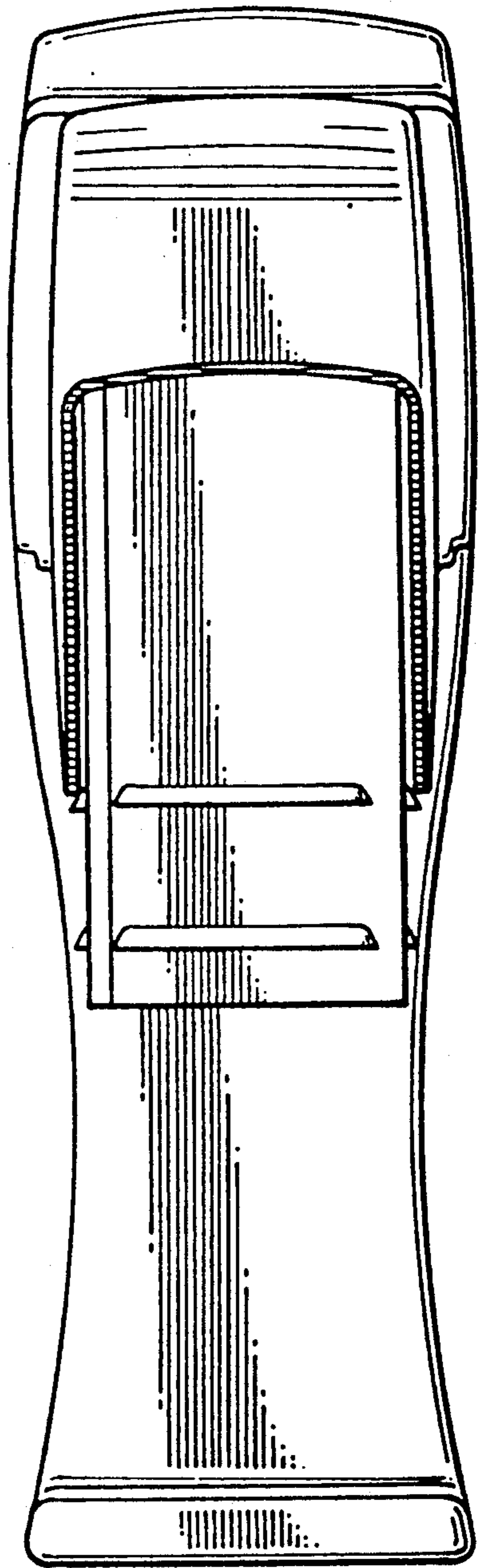

FIG. 4



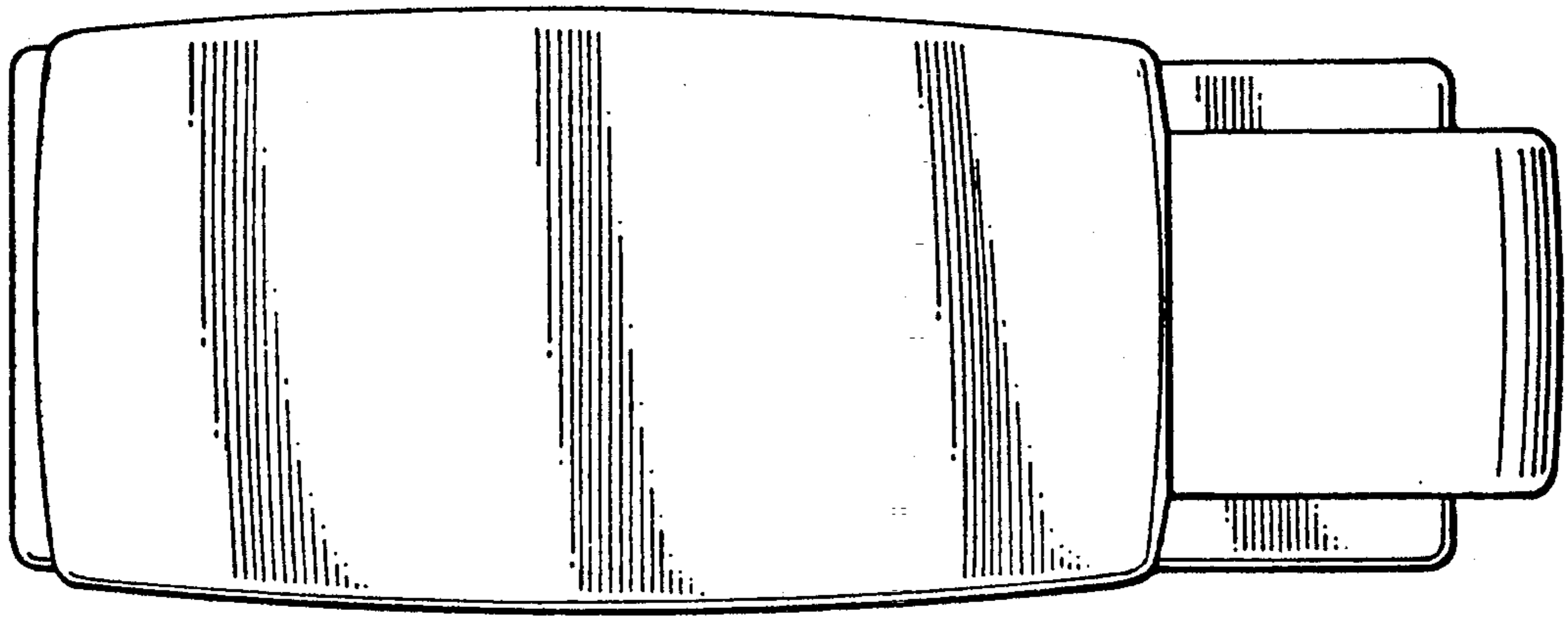

FIG. 5

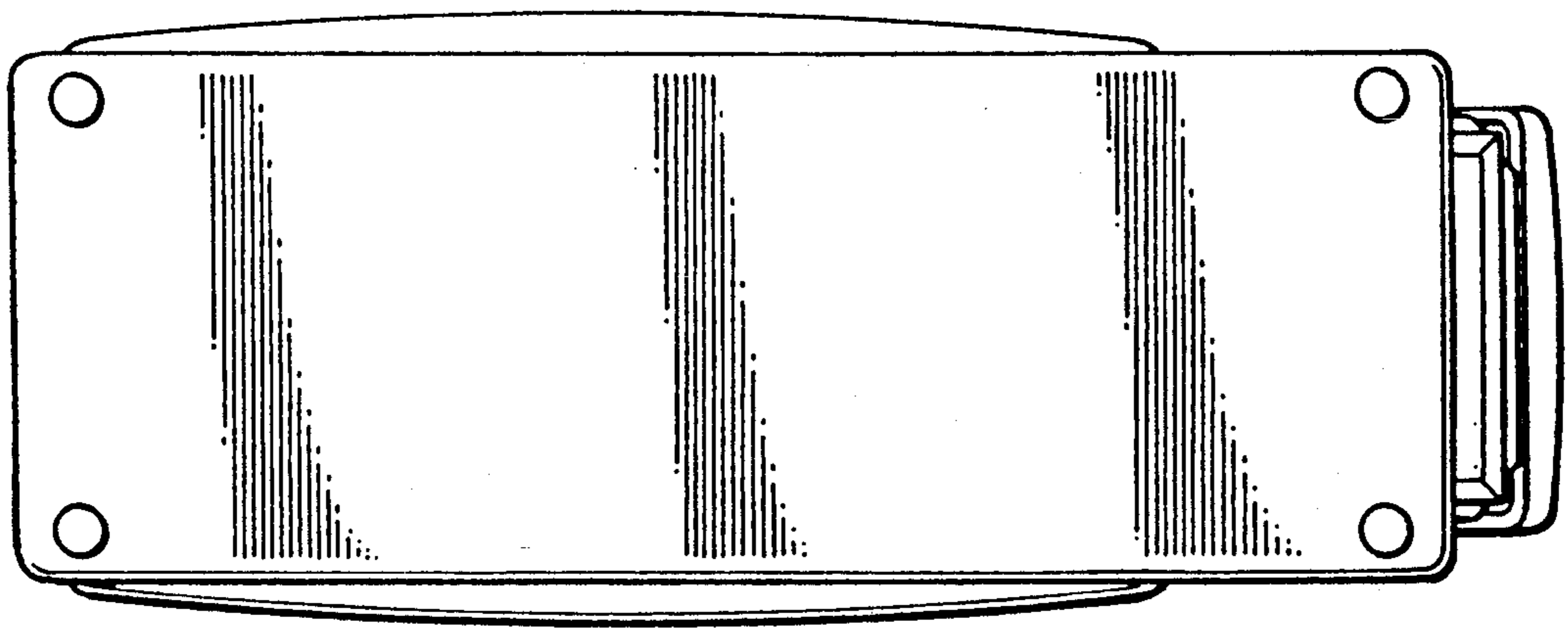

FIG. 6