



US00D328185S

United States Patent [19]

[11] Patent Number: **Des. 328,185**

Harry

[45] Date of Patent: **** Jul. 28, 1992**

[54] TELEVISION STAND FOR A VAN OR THE LIKE

Primary Examiner—Louis S. Zarfes
Attorney, Agent, or Firm—Berne S. Broadbent

[76] Inventor: Richard E. Harry, 1001 Military Dr., Salt Lake City, Utah 84105

[57] CLAIM

[**] Term: 14 Years

The ornamental design for a television stand for a van or the like, as shown and described.

[21] Appl. No.: 603,848

DESCRIPTION

[22] Filed: Oct. 25, 1990

[52] U.S. Cl. D3/40; D12/155

[58] Field of Search D3/40; D12/155;
224/42.11, 42.42, 273, 275, 308, 311, 318, 327,
329; 296/37.1, 37.5, 37.8, 37.12

FIG. 1 is a perspective view of a television stand for a van or the like showing my new design, it being understood that the broken line showing of a television and a portion of the interior of a van is for illustrative purposes only;

[56] References Cited

U.S. PATENT DOCUMENTS

- D. 218,438 8/1970 Shook D3/40
- D. 279,426 7/1985 Dzak D3/40
- D. 316,183 4/1991 Pax D3/40

FIG. 2 is a perspective view thereof;
FIG. 3 is a top plan view thereof;
FIG. 4 is a front elevational view thereof;
FIG. 5 is a right side elevational view thereof;
FIG. 6 is a left side elevational view thereof;
FIG. 7 is a rear elevational view thereof; and,
FIG. 8 is a bottom plan view thereof.

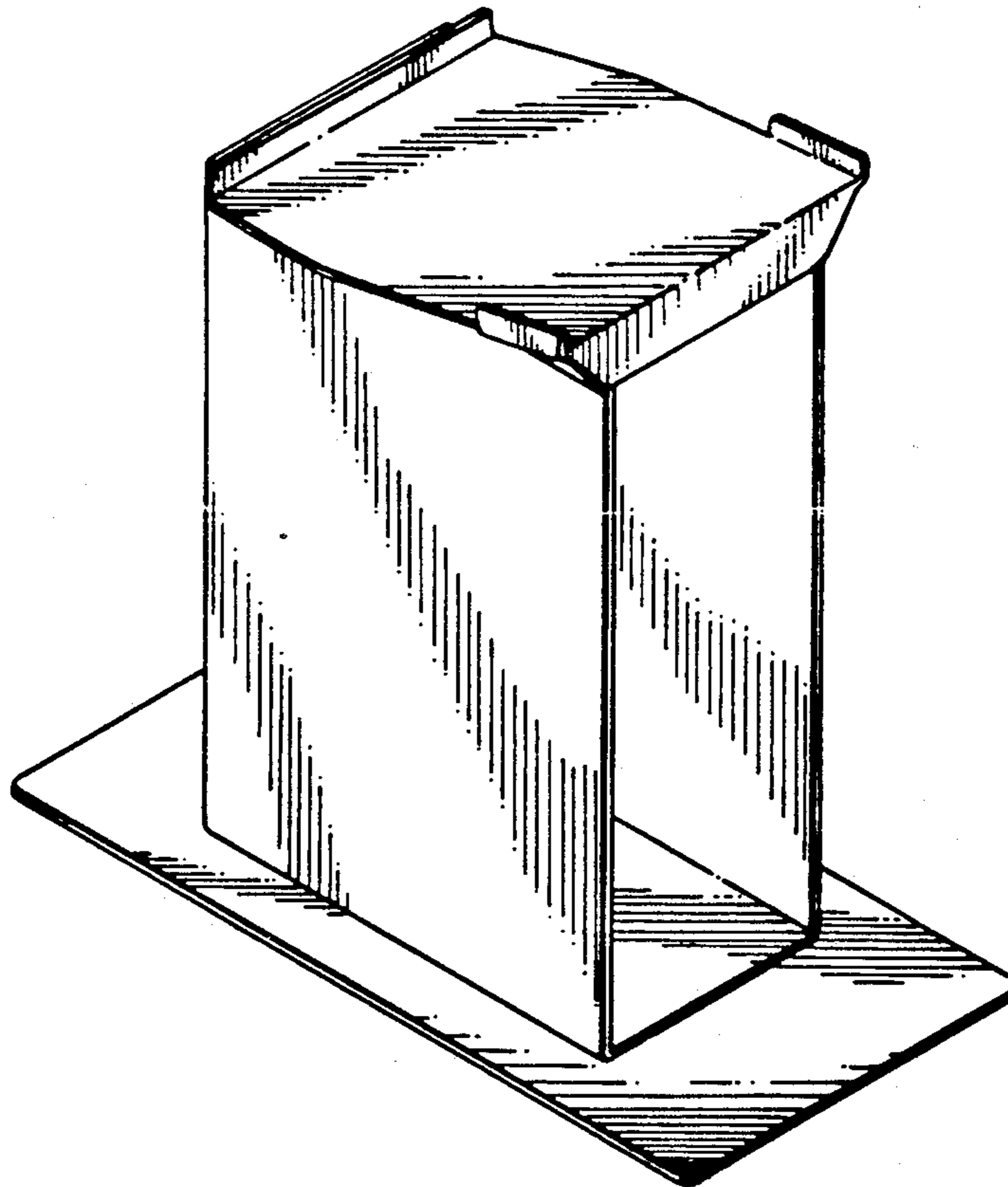

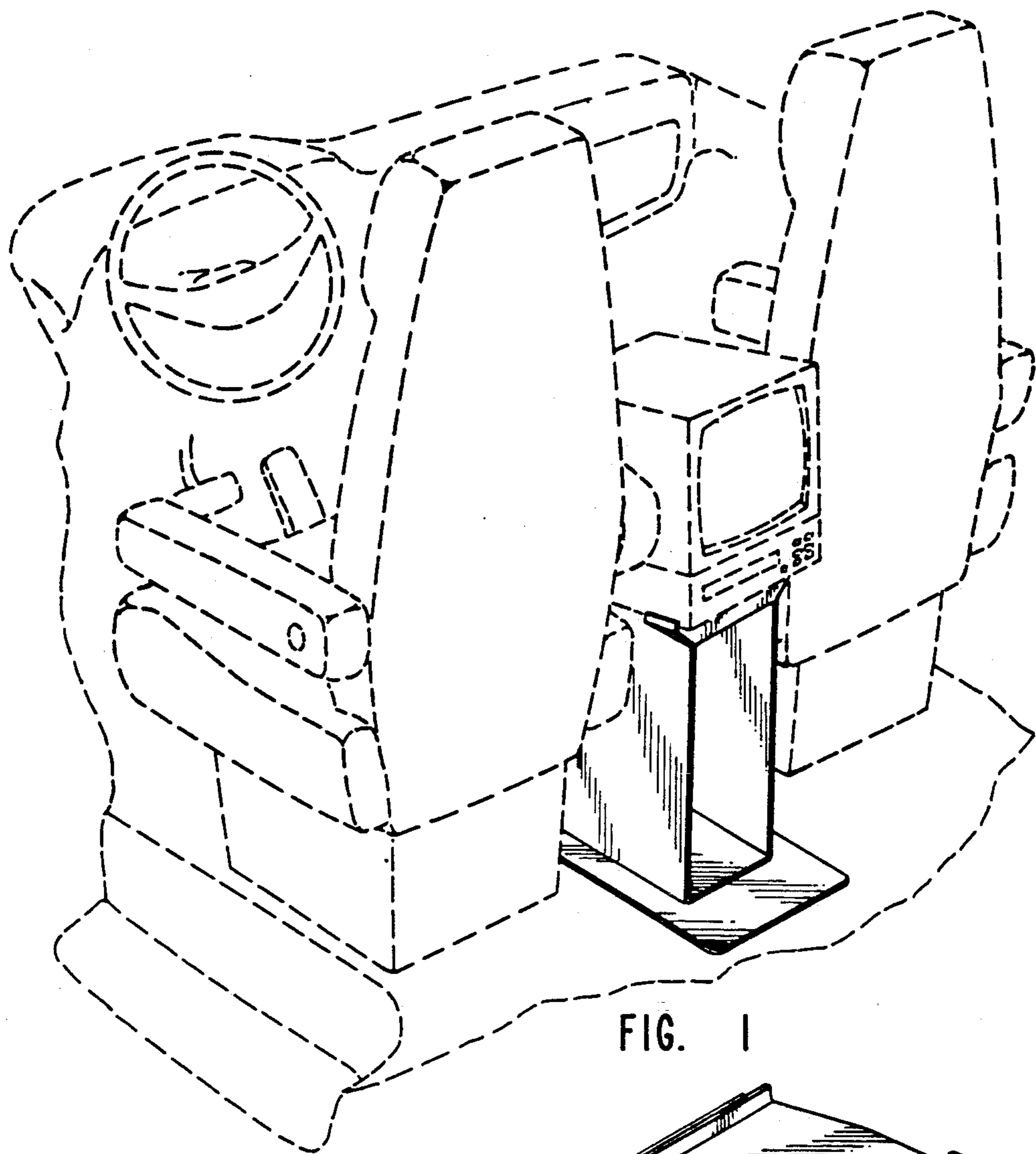

FIG. 1

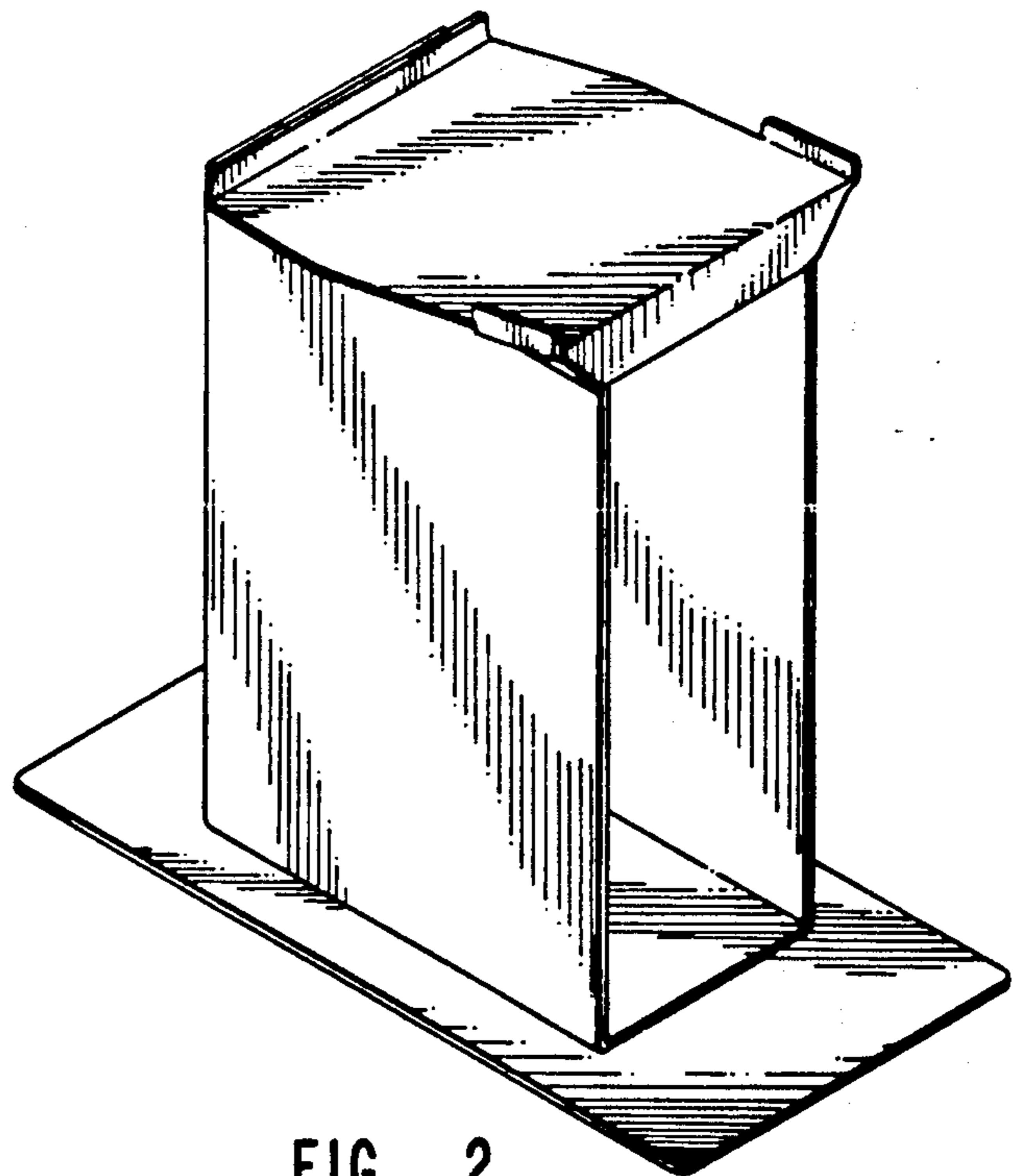

FIG. 2

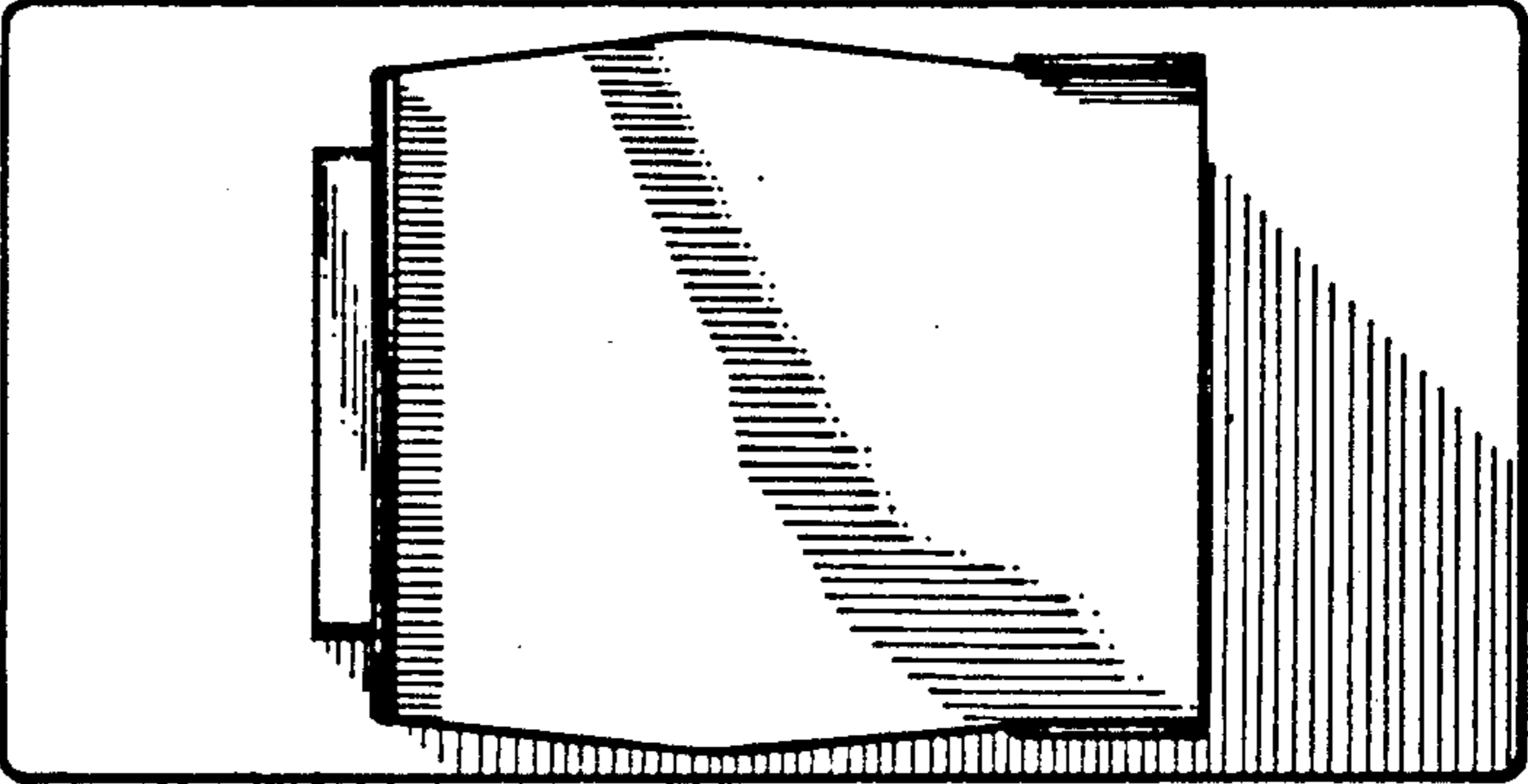

FIG. 3

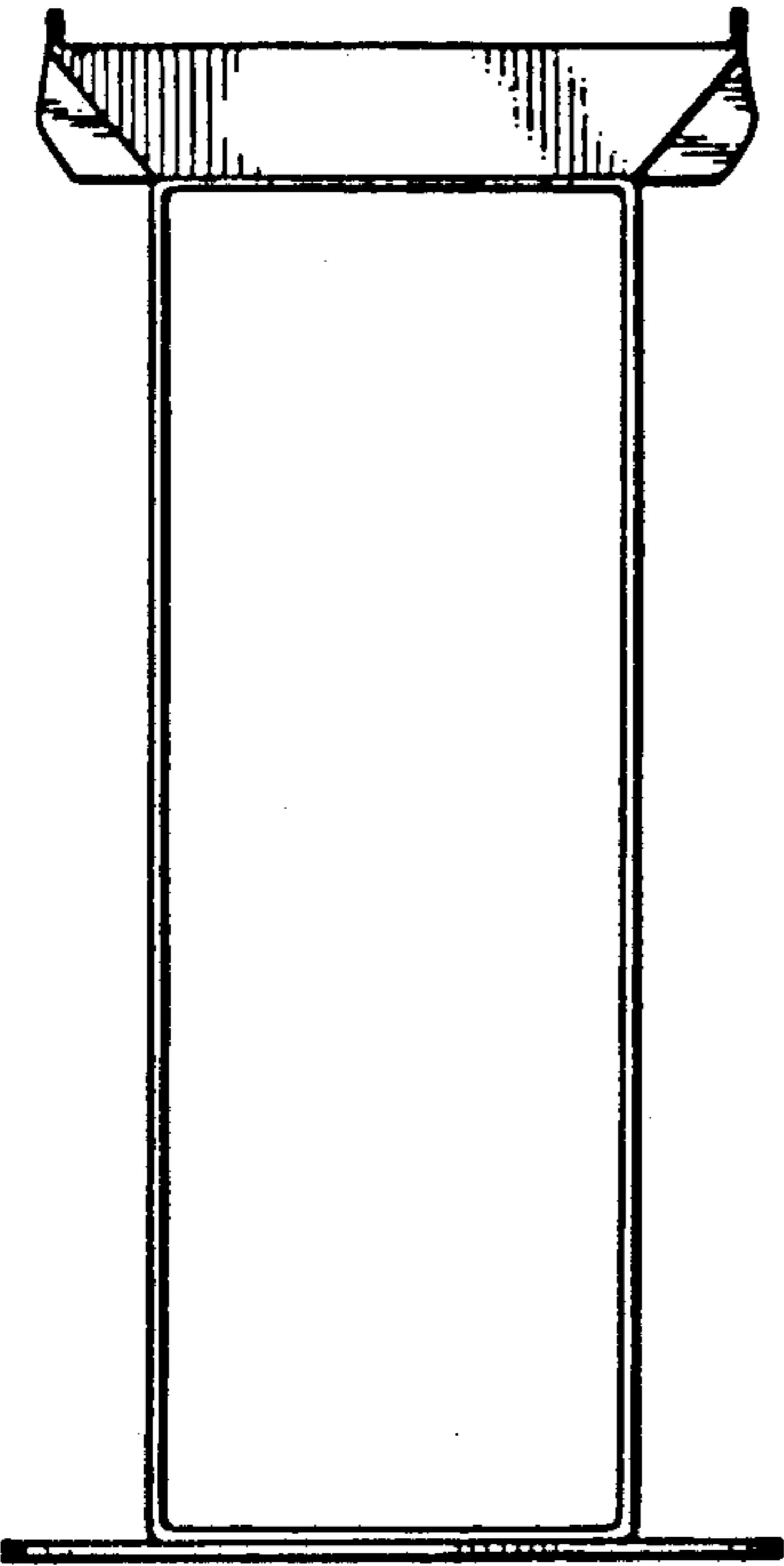

FIG. 4

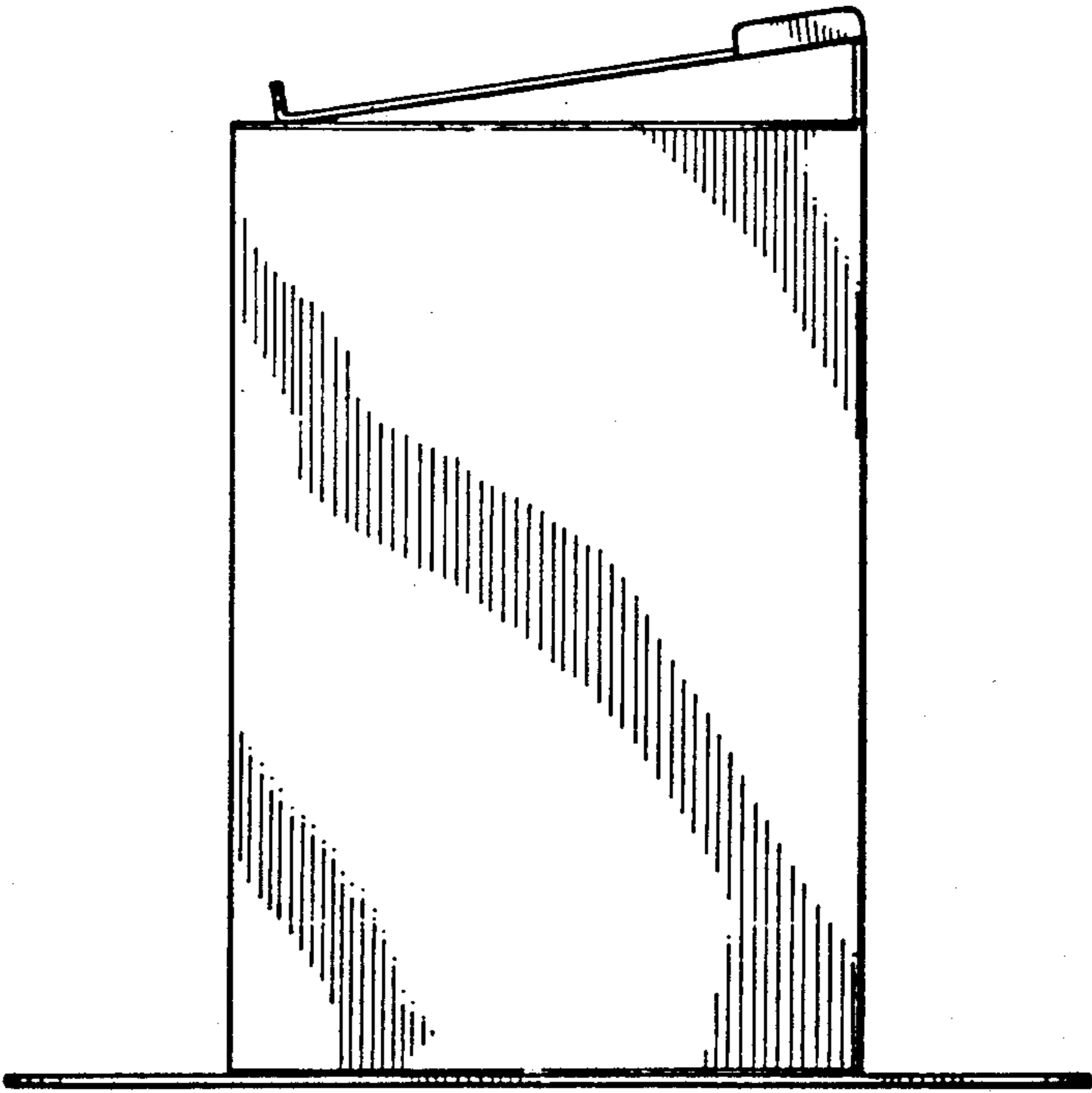

FIG. 5

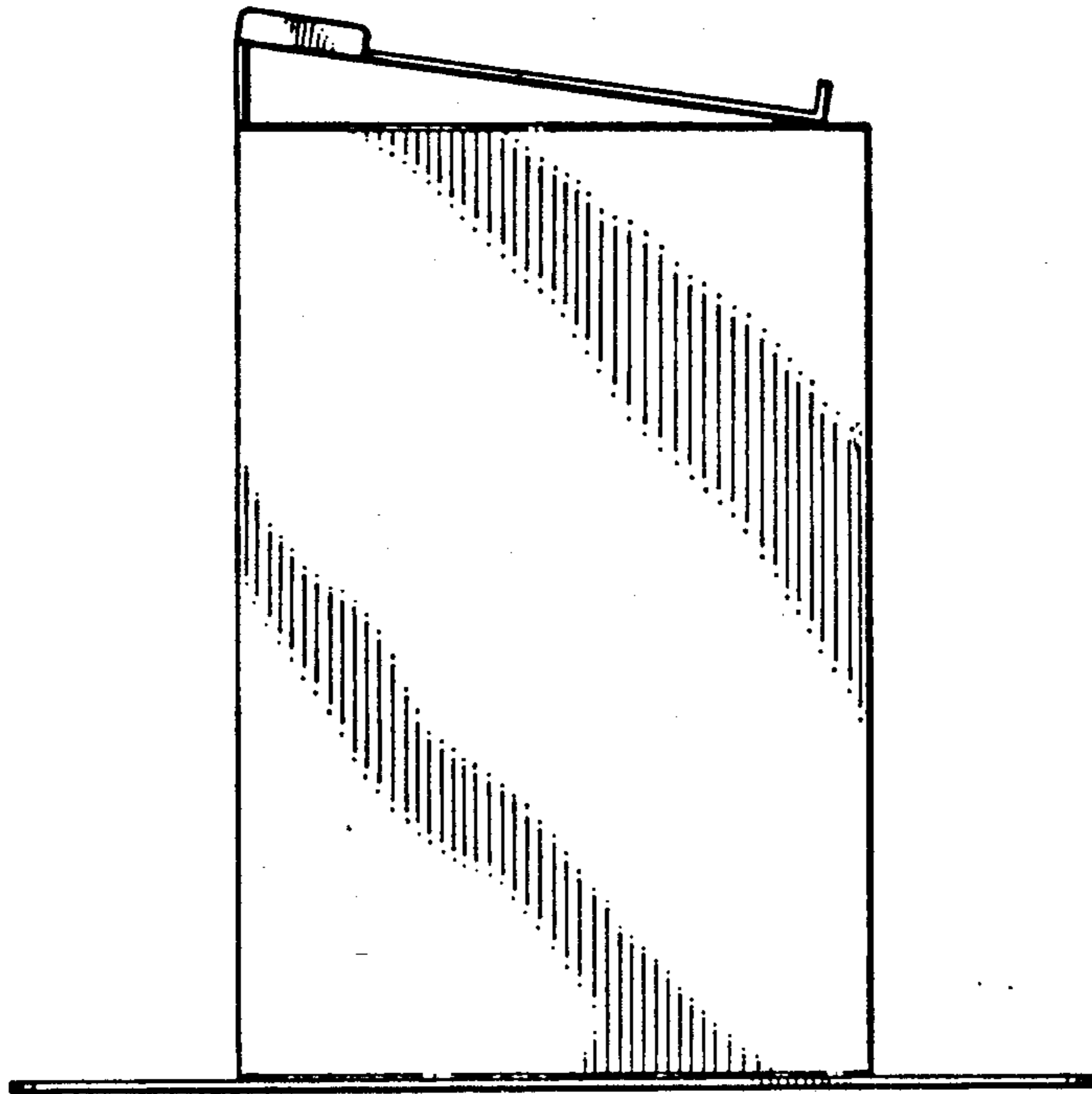

FIG. 6

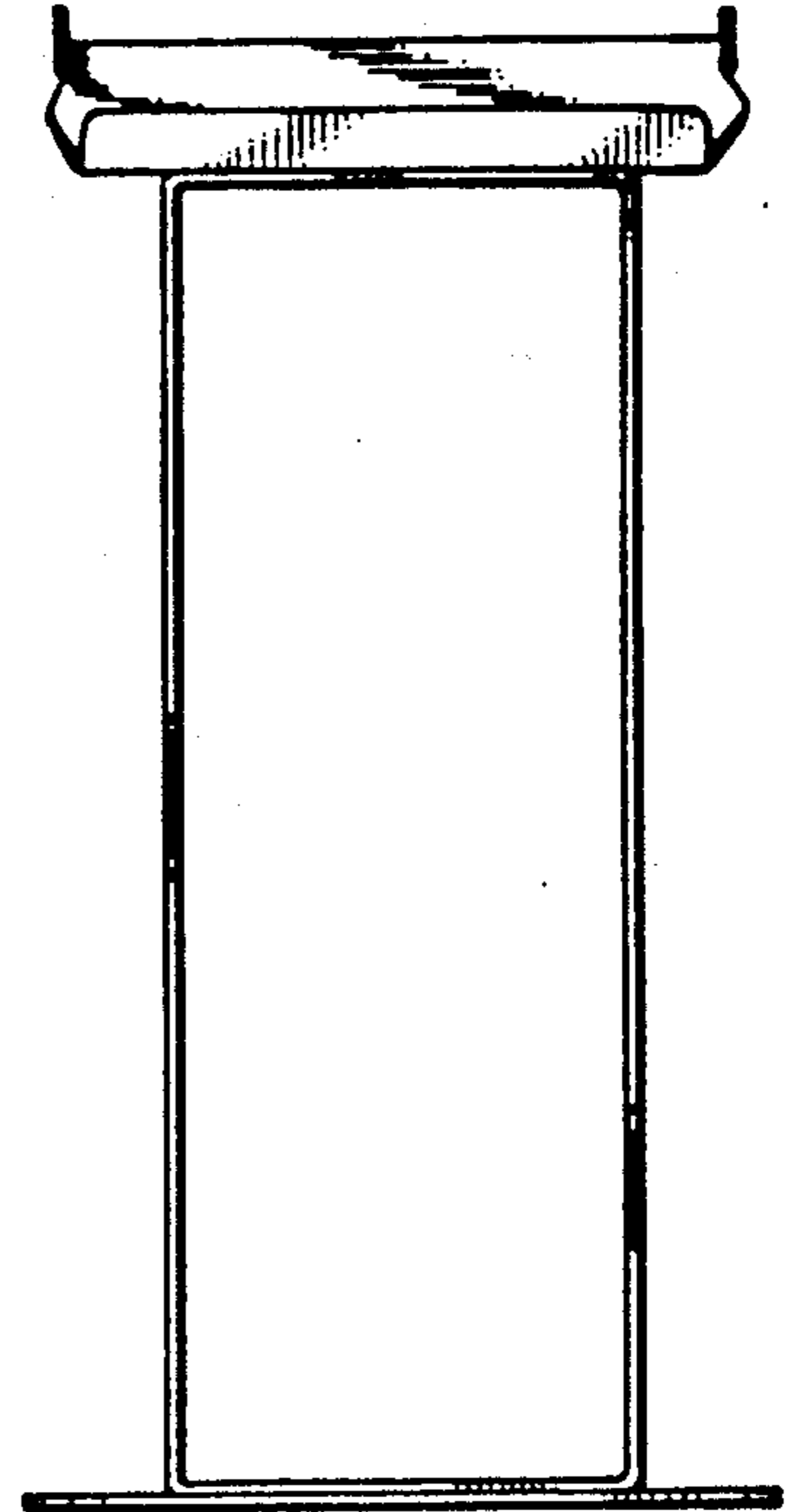

FIG. 7

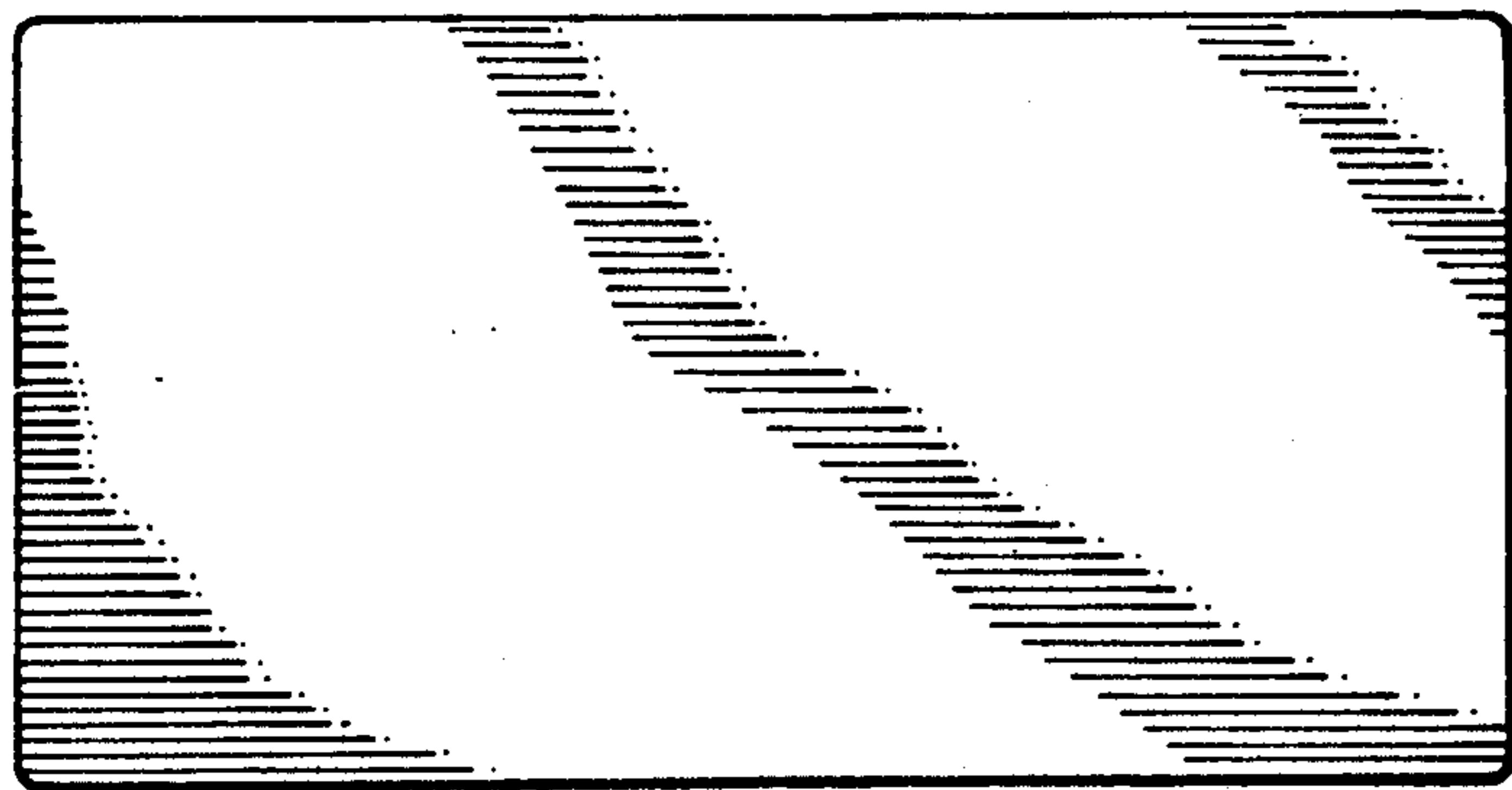

FIG. 8