



US00D328120S

United States Patent [19] Aigner

[11] Patent Number: **Des. 328,120**

[45] Date of Patent: **** Jul. 21, 1992**

[54] **PISTOL WITH TWO GRIPS**

[75] Inventor: **Friedrich Aigner, St. Valentin, Austria**

[73] Assignee: **Steyr-Daimler-Puch AG, Vienna, Austria**

[**] Term: **14 Years**

[21] Appl. No.: **378,605**

[22] Filed: **Jul. 12, 1989**

[30] **Foreign Application Priority Data**

Mar. 2, 1989 [AT] Austria 548.521-528
[52] U.S. Cl. **D22/104**
[58] Field of Search D22/104; 42/92, 75.02;
89/195, 33.1, 125, 161, 189

[56] **References Cited**

U.S. PATENT DOCUMENTS

1,363,809 12/1920 Payne 42/72 X
2,324,125 7/1943 Van Horn et al. 42/72 X
3,630,119 12/1971 Perrine 42/75.02 X
4,640,036 2/1987 Gal 42/72

OTHER PUBLICATIONS

Gun World, Aug. 1988, p. 3, Semi-Automatic Guns,

Items A and B—Item A at top of page. Item B at bottom of page.

Primary Examiner—Wallace R. Burke
Assistant Examiner—H. Baynham
Attorney, Agent, or Firm—Marmorek, Guttman & Rubenstein

[57] **CLAIM**

The ornamental design for a pistol with two grips, as shown and described.

DESCRIPTION

FIG. 1 is a left side elevational view of a pistol with two grips showing my new design;
FIG. 2 is a right side elevational view thereof;
FIG. 3 is a top plan view thereof;
FIG. 4 is a front elevational view thereof;
FIG. 5 is a rear elevational view thereof;
FIG. 6 is a top, front perspective view thereof; and
FIG. 7 is a bottom perspective view thereof.

The broken lines showing a semi-automatic magazine are for illustrative purposes only and form no part of the claimed design.

The ornamental design for a pistol with two grips, as shown and described.

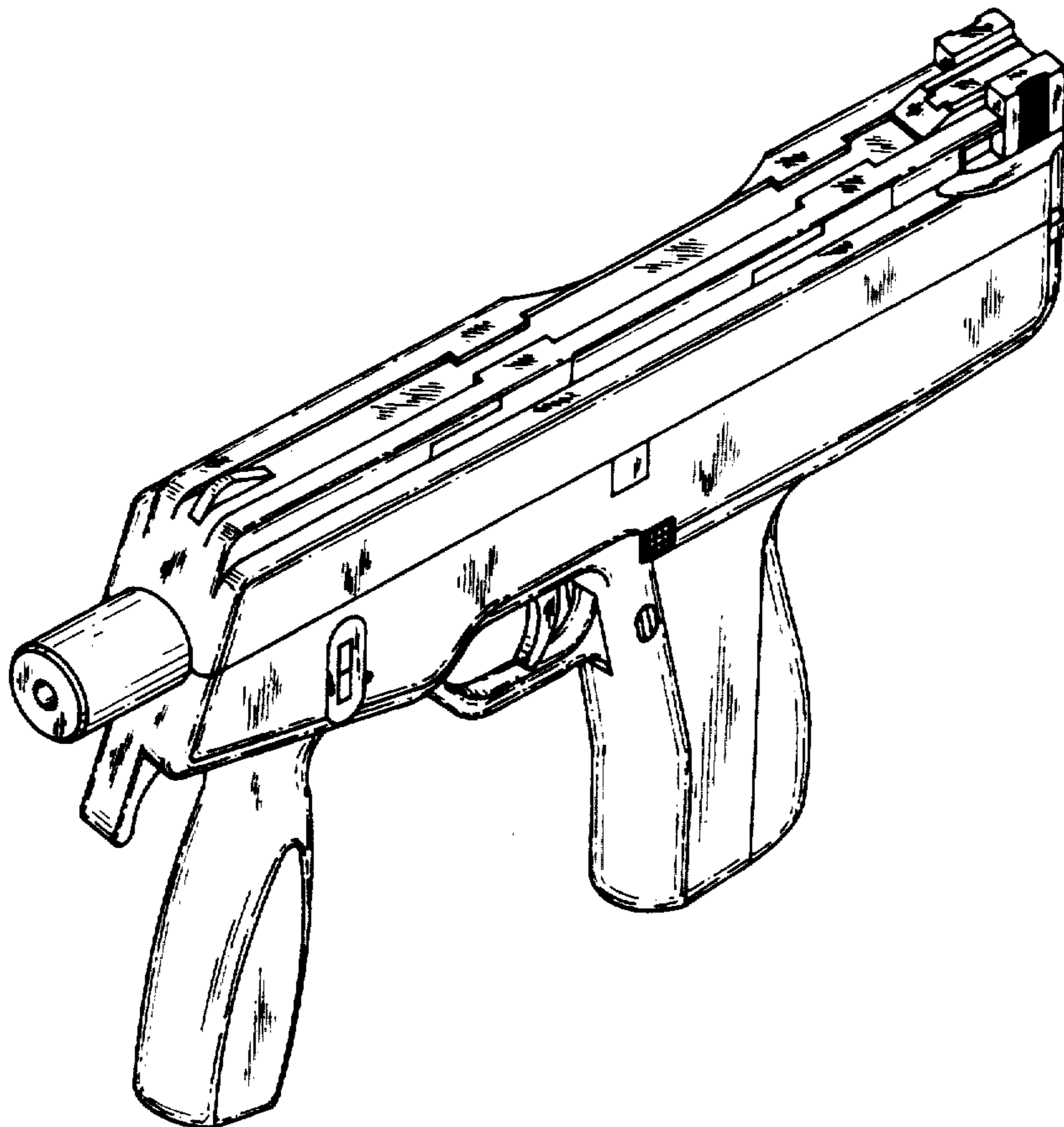

FIG. 1

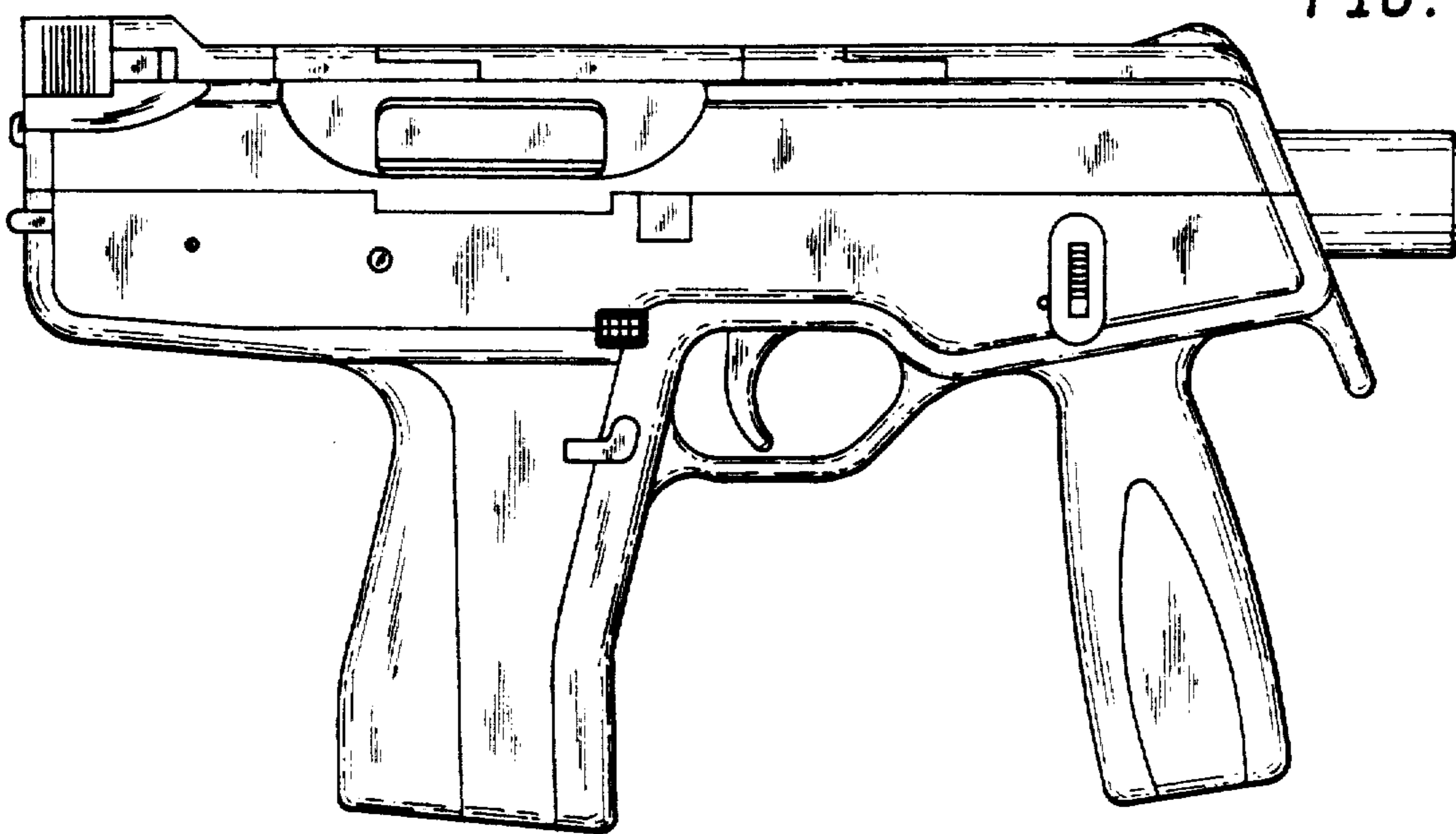

FIG. 2

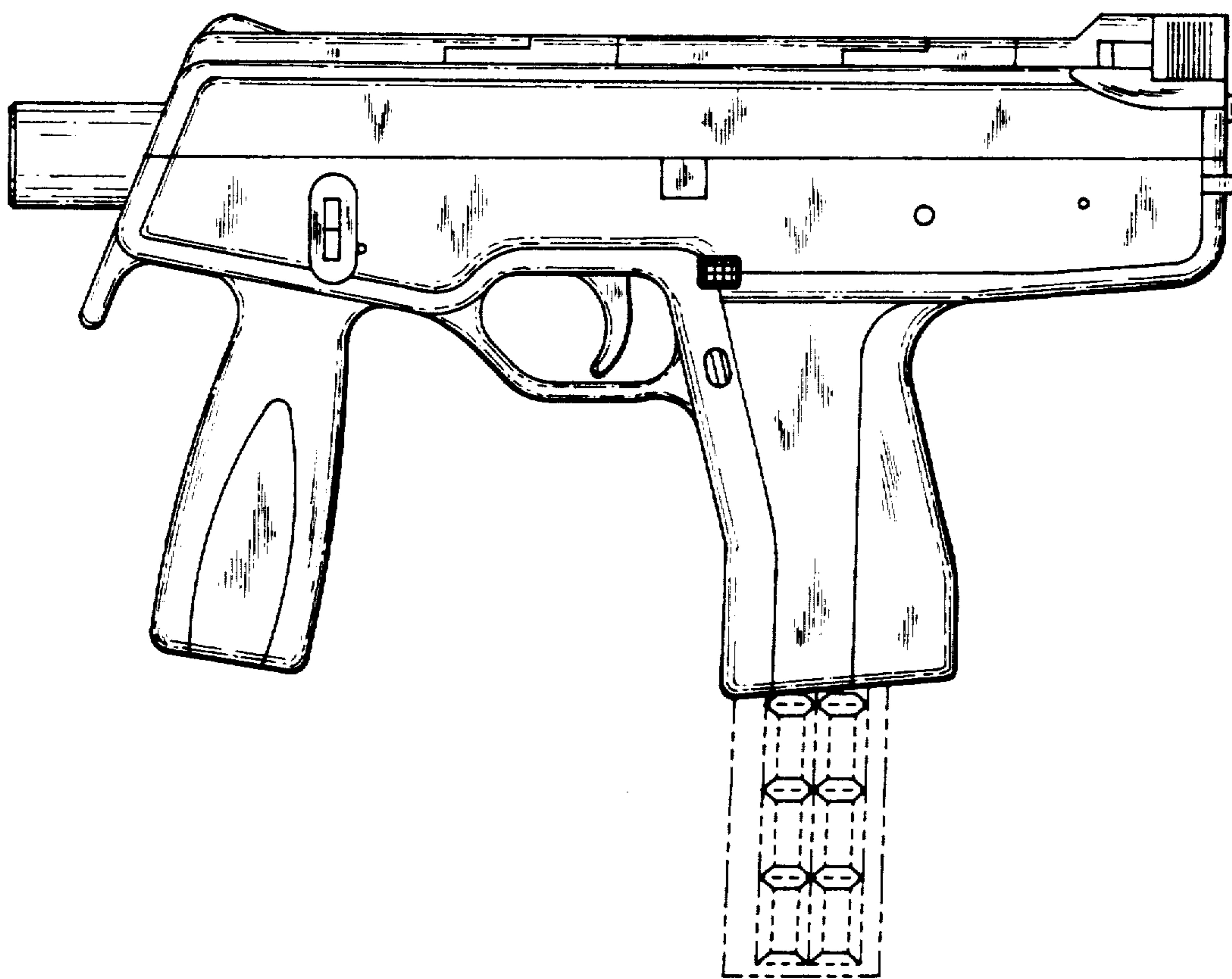

FIG. 3

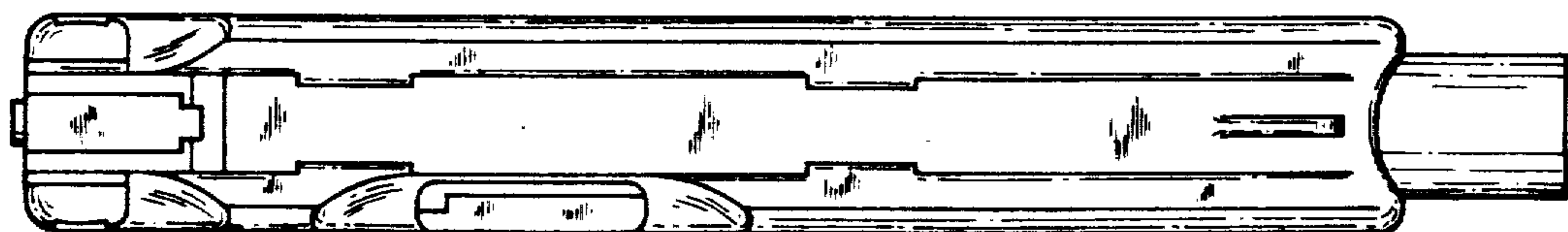

FIG. 4

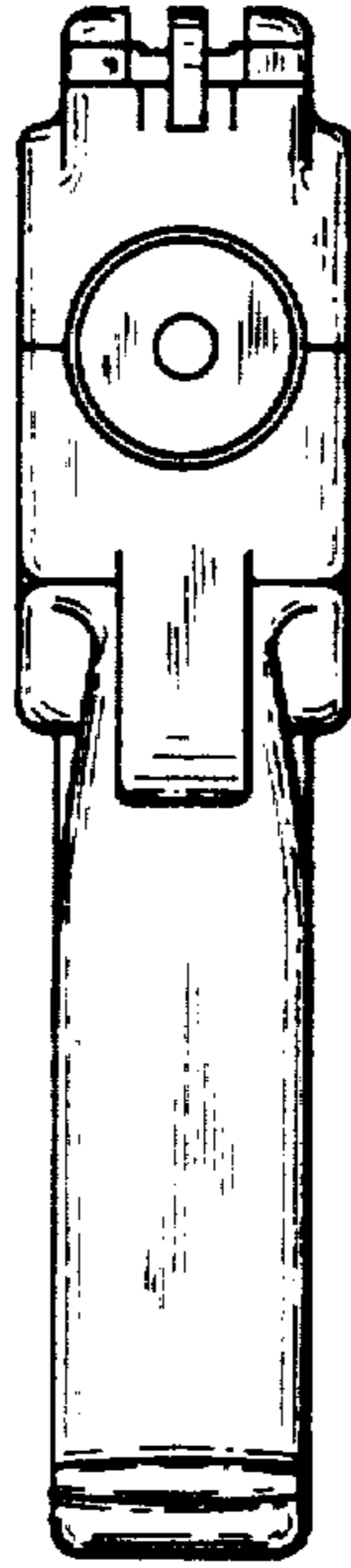

FIG. 5

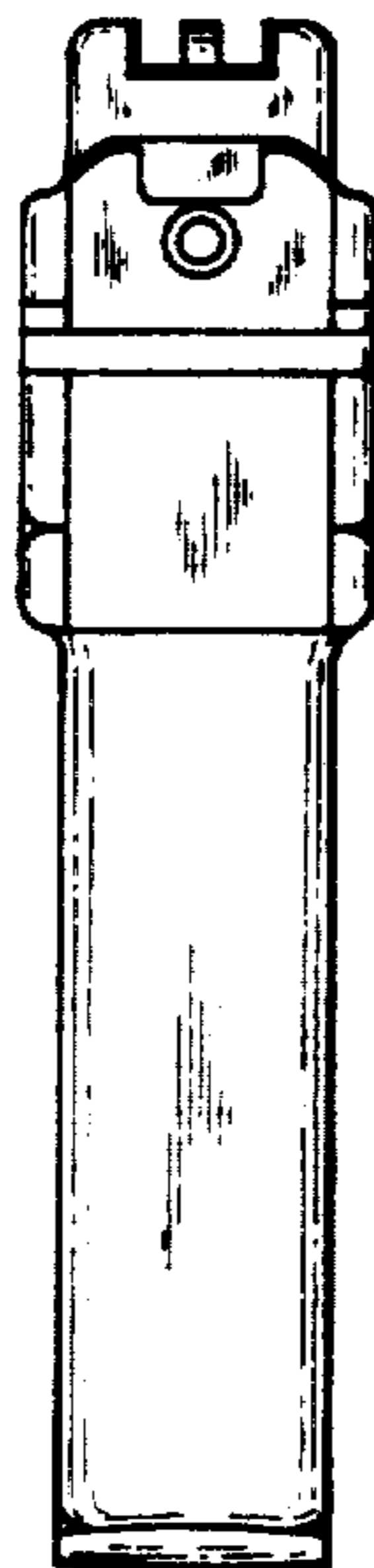

FIG. 6

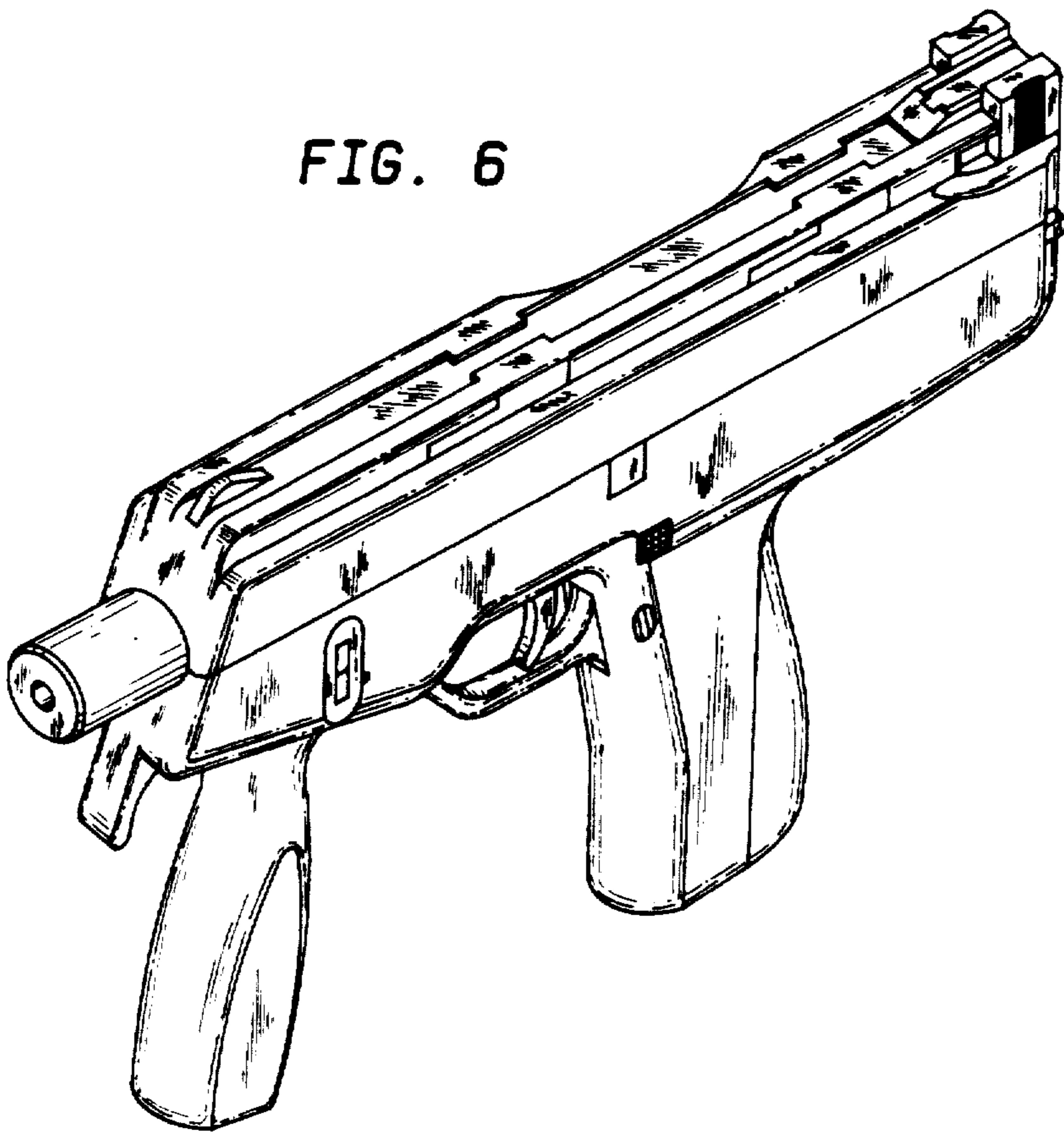

FIG. 7

