



US00D328113S

# United States Patent [19]

Wilkinson et al.

[11] Patent Number: Des. 328,113

[45] Date of Patent: \*\* Jul. 21, 1992

[54] WRIST EXERCISER

4,838,542 6/1989 Wilkinson ..... 272/122

[75] Inventors: William T. Wilkinson, Chesapeake City, Md.; Gregory J. Gayle, Wilmington, Del.

Primary Examiner—Charles A. Rademaker  
Attorney, Agent, or Firm—Connolly & Hutz

[73] Assignee: Whatnot, Inc., Cleveland, Ohio

[57] CLAIM

[\*\*] Term: 14 Years

The ornamental design for a wrist exerciser, as shown and described.

[21] Appl. No.: 560,895

DESCRIPTION

[22] Filed: Jul. 31, 1990

[52] U.S. Cl. .... D21/198

[58] Field of Search ..... D21/191-199;  
272/122, 123, 124, 125, 67, 68, 143

FIG. 1 is a side elevational view of a wrist exerciser showing our new design, the side opposite being identical;

FIG. 2 is an end elevational view thereof;

FIG. 3 is an end elevational view of the end opposite that shown in FIG. 2;

FIG. 4 is a front elevational view of a modified embodiment of the design shown in FIGS. 1 through 3;

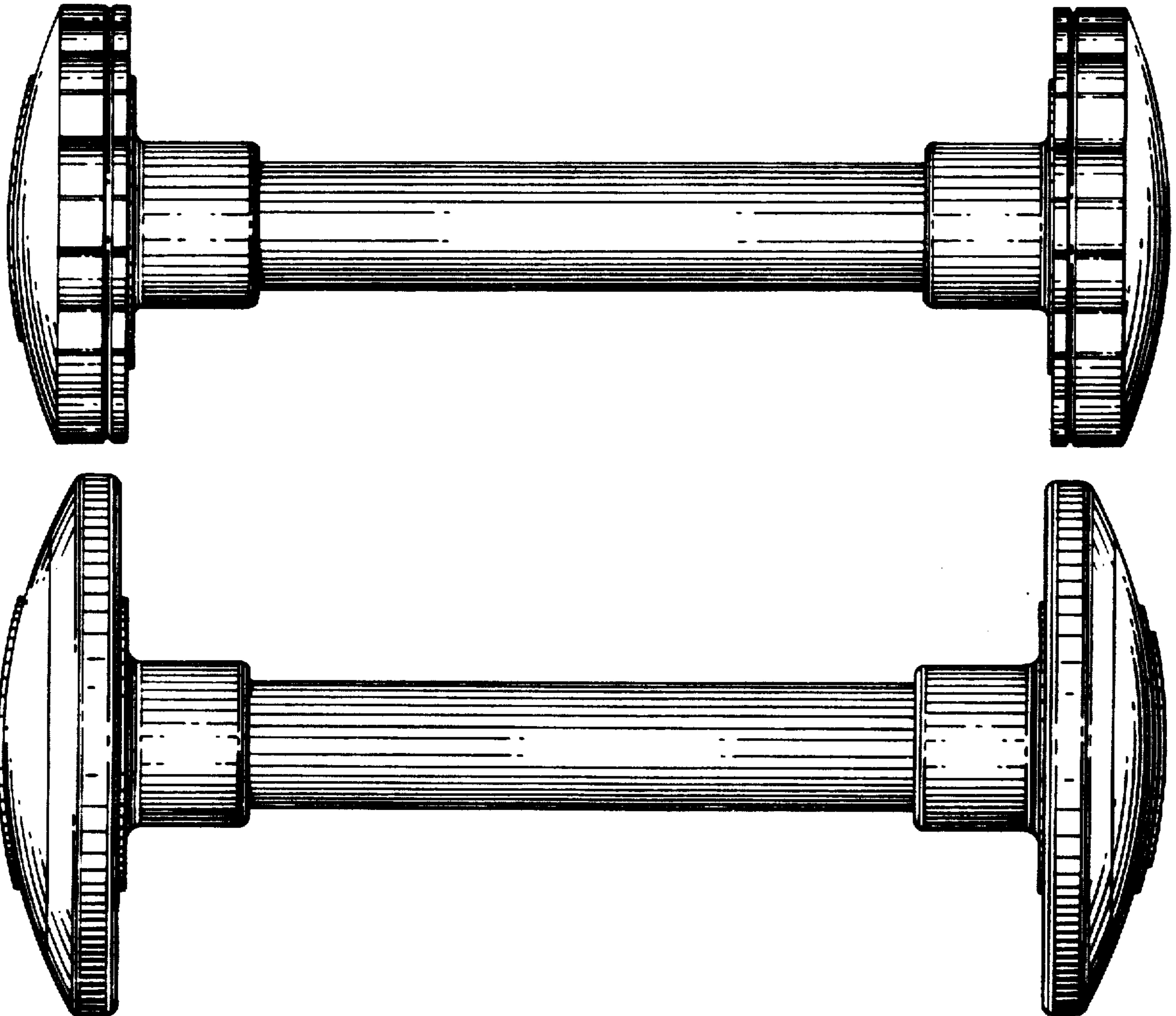
FIG. 5 is a right side elevational view thereof; and,

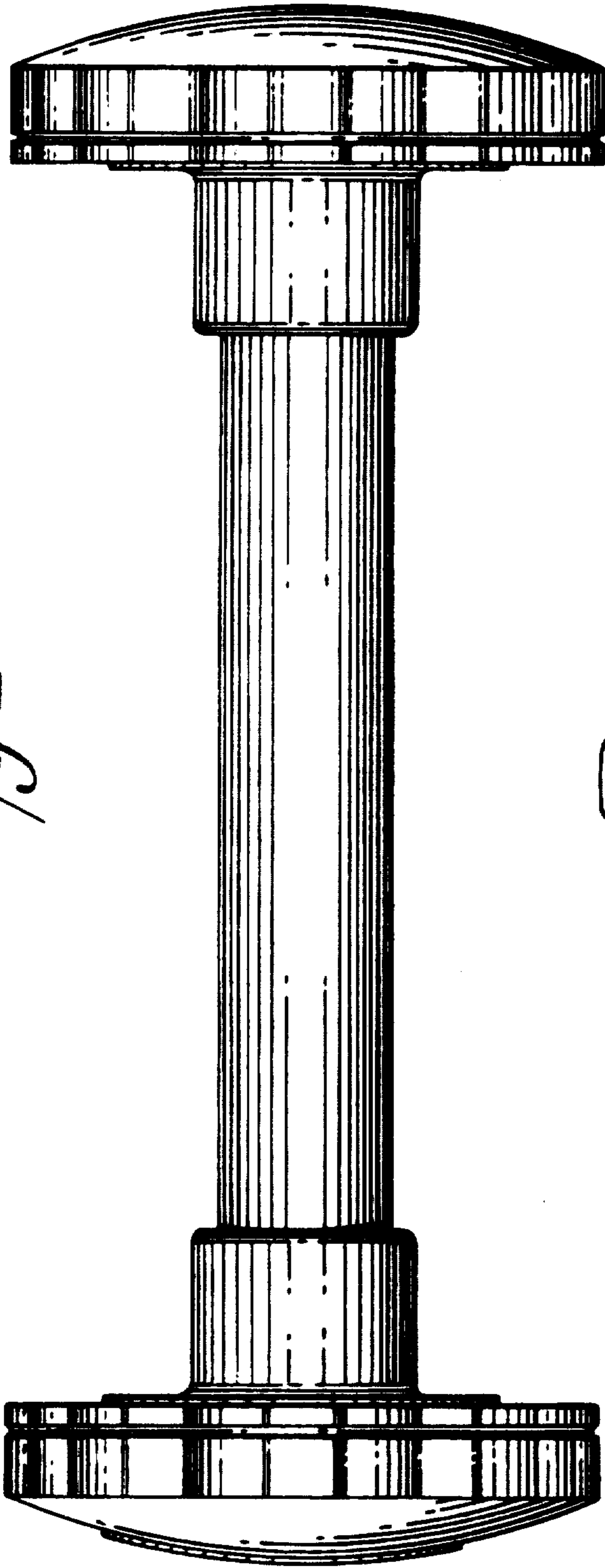
FIG. 6 is a left side elevational view thereof.

[56] References Cited

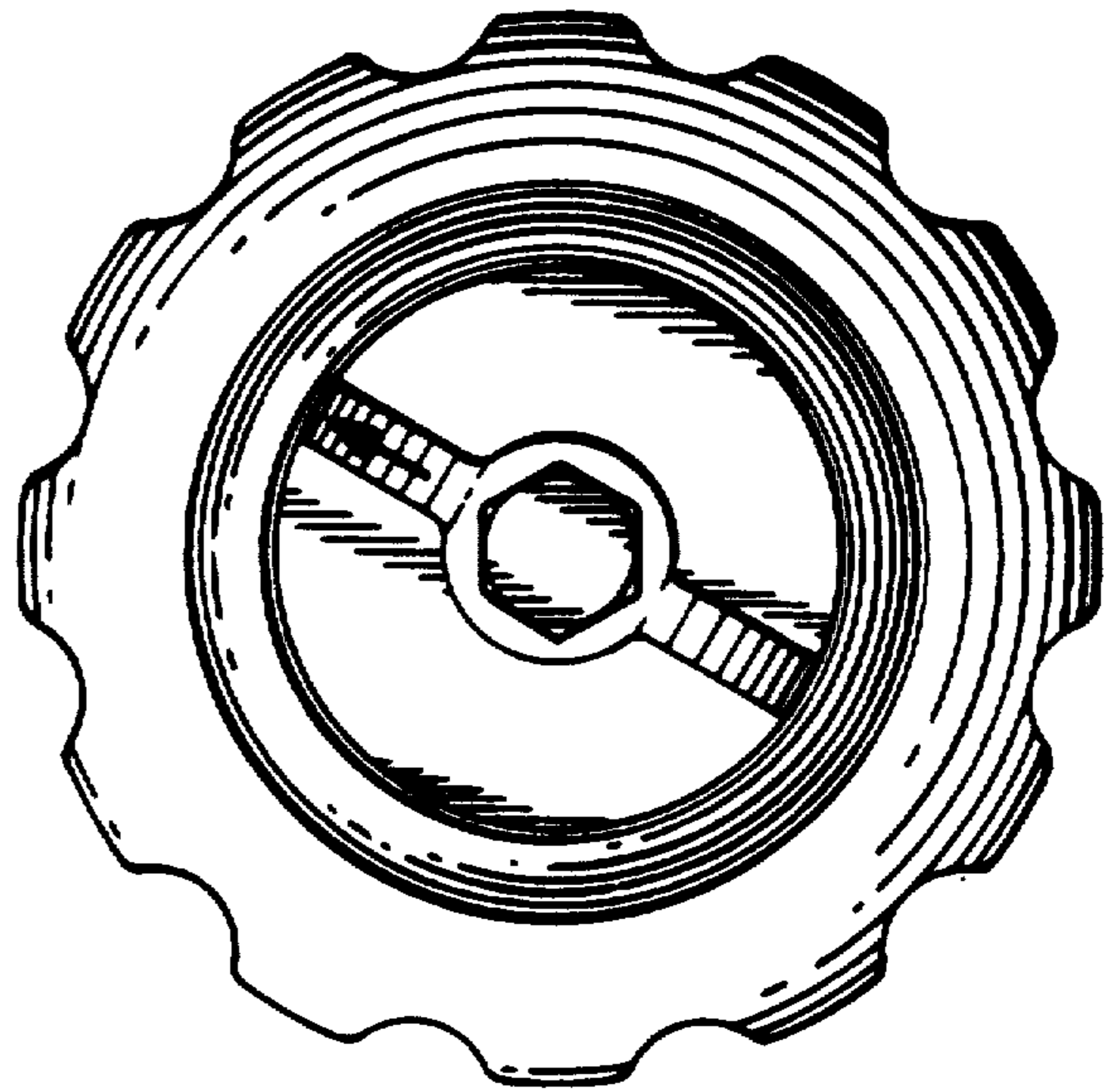
U.S. PATENT DOCUMENTS

D. 264,983 6/1982 Logan ..... D21/198  
2,509,810 5/1950 Core ..... D21/198



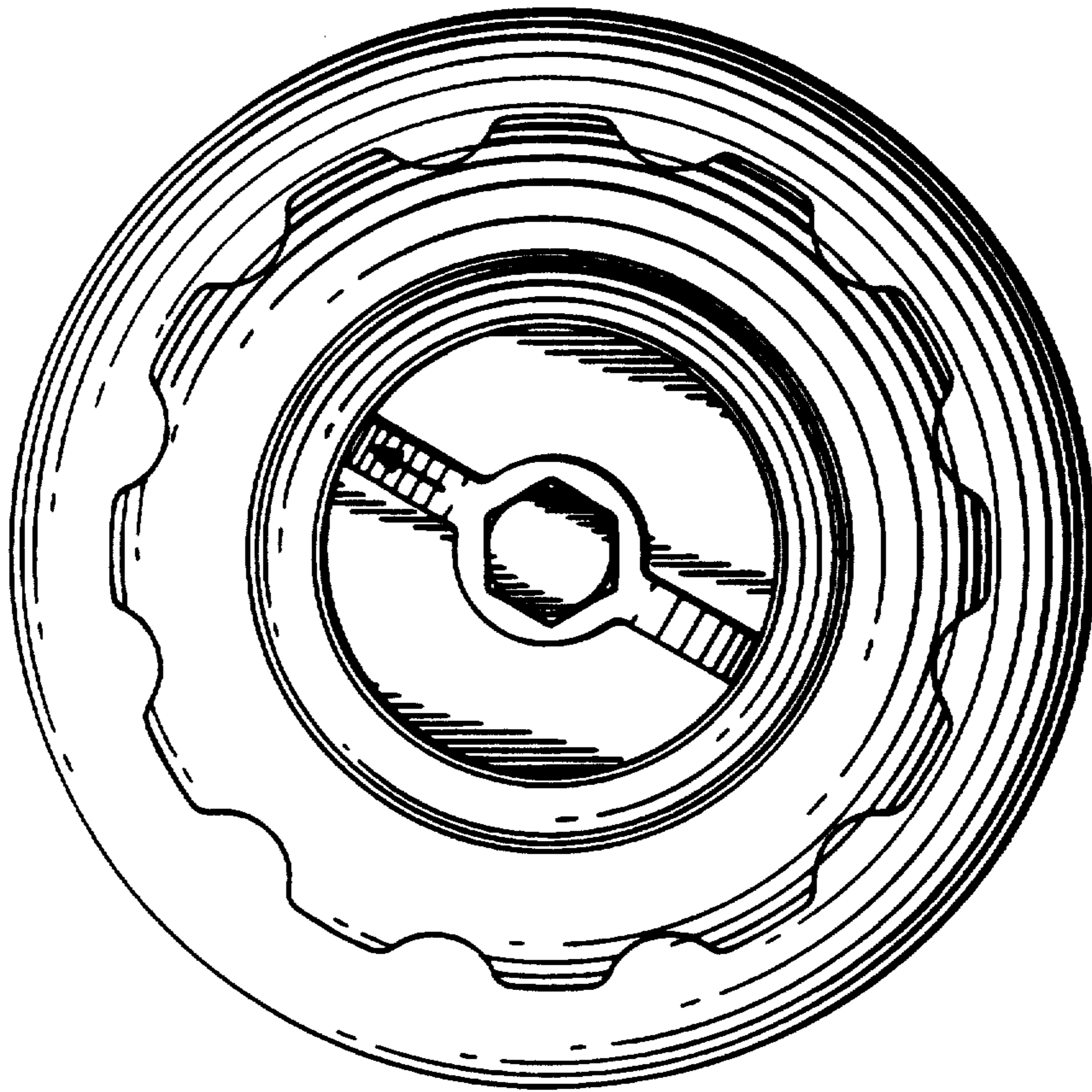


*Fig. 1.*

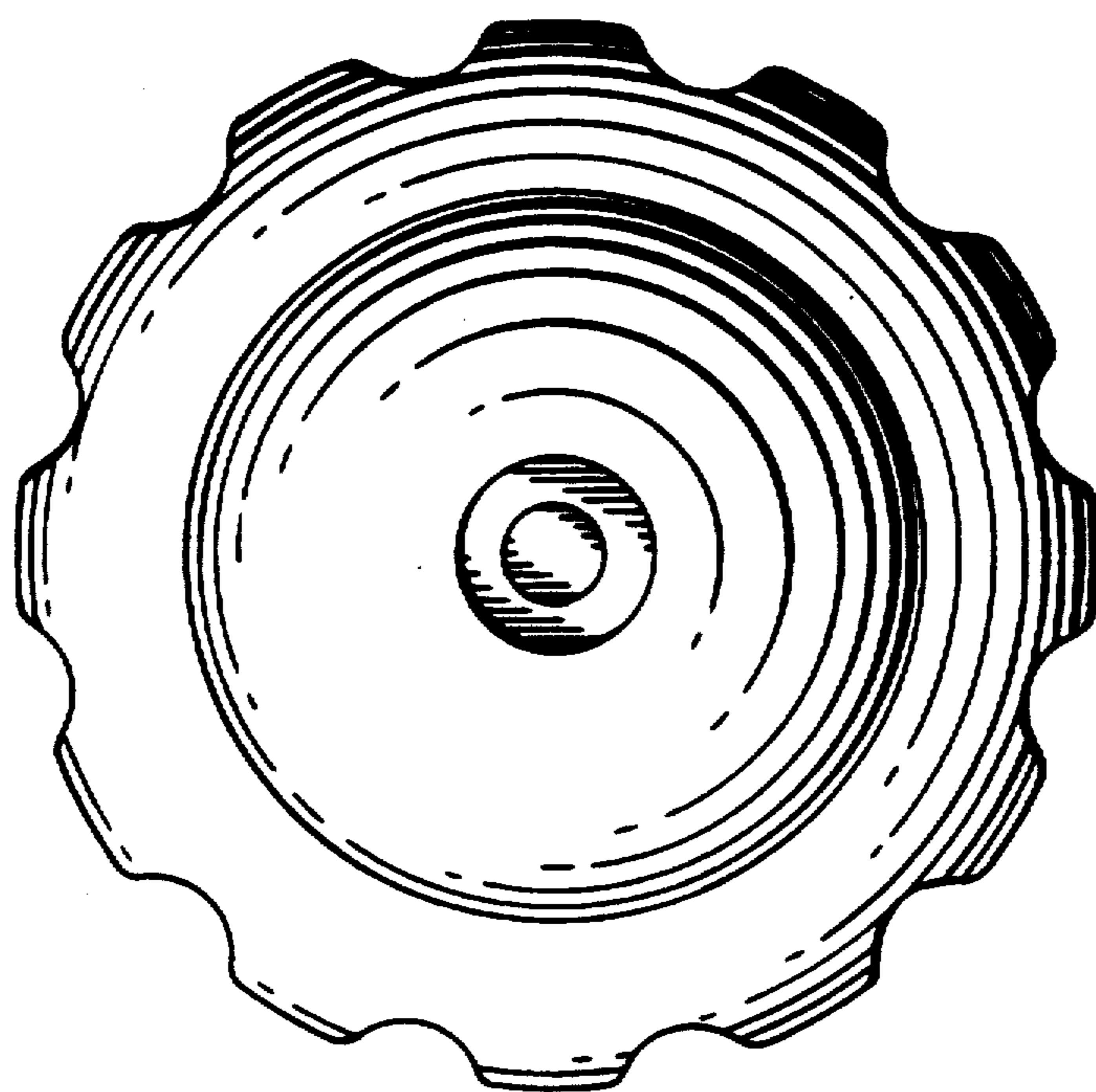


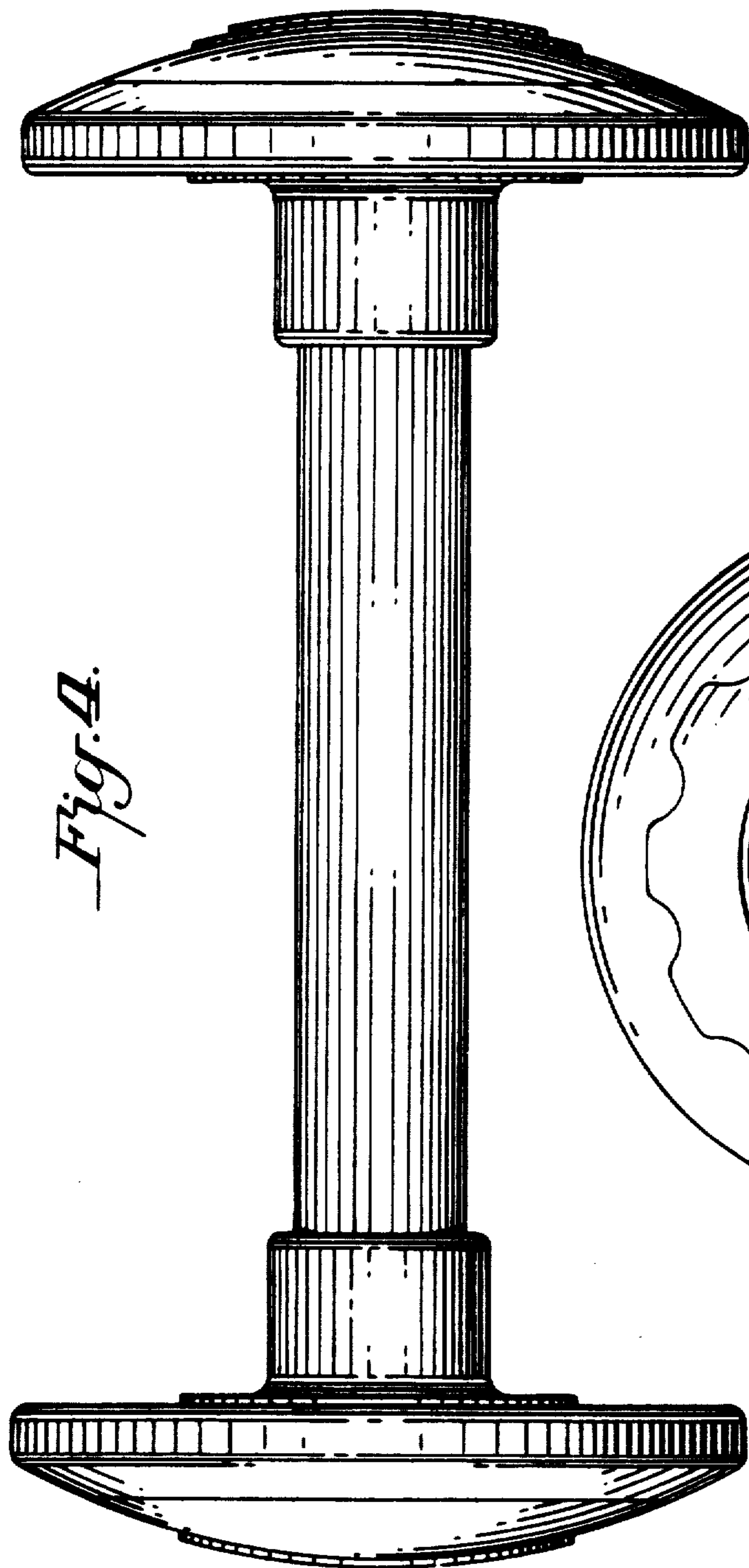
*Fig. 2.*

*Fig. 5.*

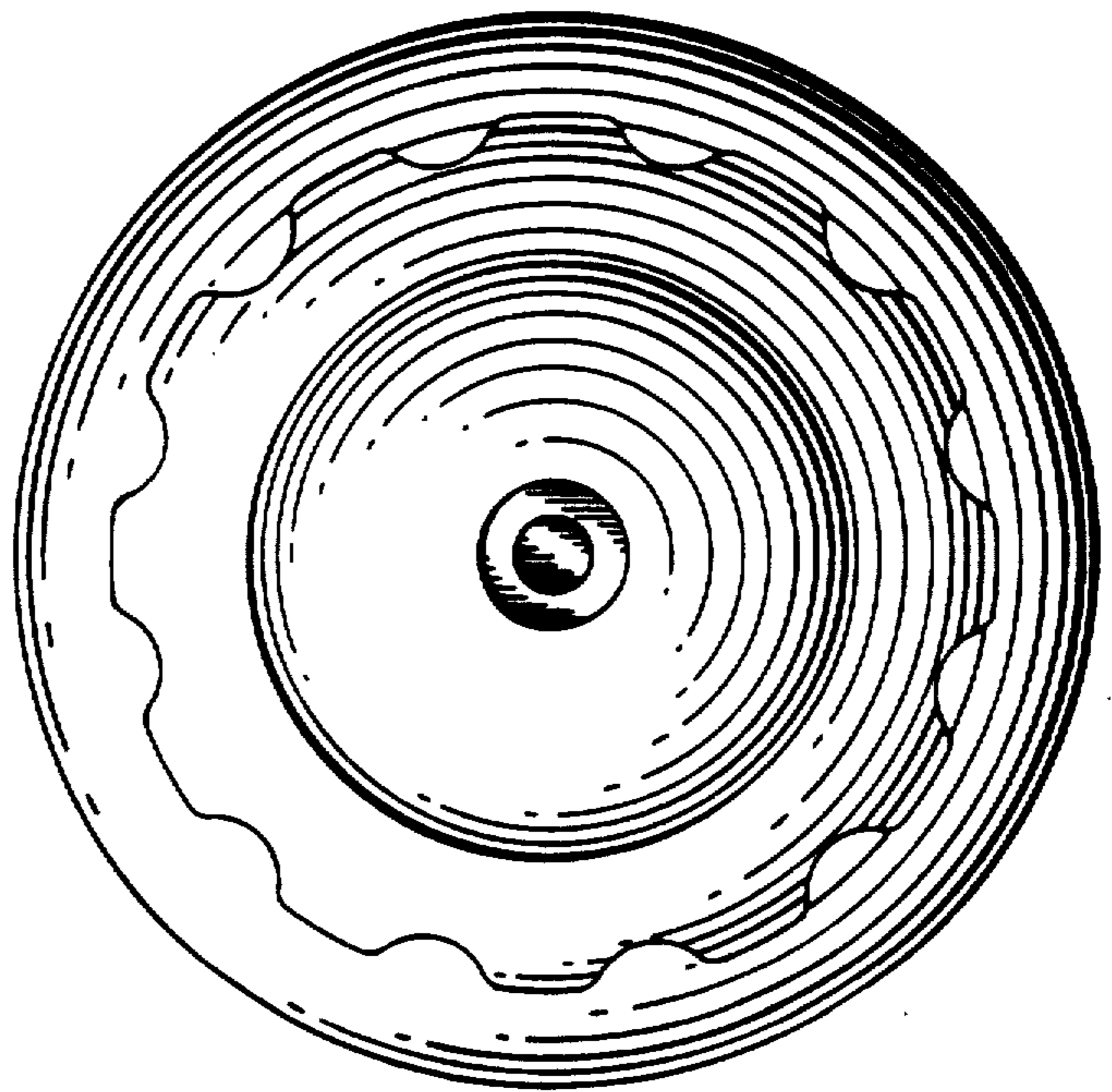


*Fig. 3.*





*Fig. 4.*



*Fig. 6.*