



US00D328014S

United States Patent [19]

[11] Patent Number: **Des. 328,014**

DeCoster et al.

[45] Date of Patent: **** Jul. 21, 1992**

[54] **COVERED CONTAINER OR THE LIKE**

3,380,592 4/1968 Arnold .

[75] Inventors: **Pieter K. J. DeCoster**, Aalst; **Robert H. C. M. Daenen**, Erembodegem, both of Belgium

4,179,040 12/1979 Bateman et al. .

4,966,294 10/1990 Mack et al. 220/352 X

[73] Assignee: **Dart Industries, Inc.**, Deerfield, Ill.

Primary Examiner—Terry A. Pfeffer
Attorney, Agent, or Firm—John A. Doninger

[**] Term: **14 Years**

[57] **CLAIM**

[21] Appl. No.: **520,707**

The ornamental design for a covered container or the like, as shown.

[22] Filed: **May 8, 1990**

DESCRIPTION

[52] U.S. Cl. **D7/629; D9/529**

FIG. 1 is a top perspective view of the covered container or the like showing our new design;

[58] Field of Search **D7/538, 540, 542, 612-615, D7/629; D9/352, 353, 355, 425; 206/217, 804; 220/85 D, 93, 94 A, 410, 529, 544, 306**

FIG. 2 is a top plan view thereof;

FIG. 3 is a bottom plan view thereof;

FIG. 4 is a front elevational view thereof;

FIG. 5 is a rear elevational view thereof;

FIG. 6 is a right side elevational view thereof;

FIG. 7 is a left side elevational view thereof;

FIG. 8 is a cross-sectional view taken along line 8—8 of FIG. 3; and,

FIG. 9 is a cross-sectional view taken along line 9—9 of FIG. 6.

[56] **References Cited**

U.S. PATENT DOCUMENTS

- D. 257,201 10/1980 Croyle et al. .
- 2,334,595 11/1943 Bailey .
- 2,904,205 9/1959 Callery .
- 3,040,897 6/1962 Holman .
- 3,249,250 5/1966 McKee .

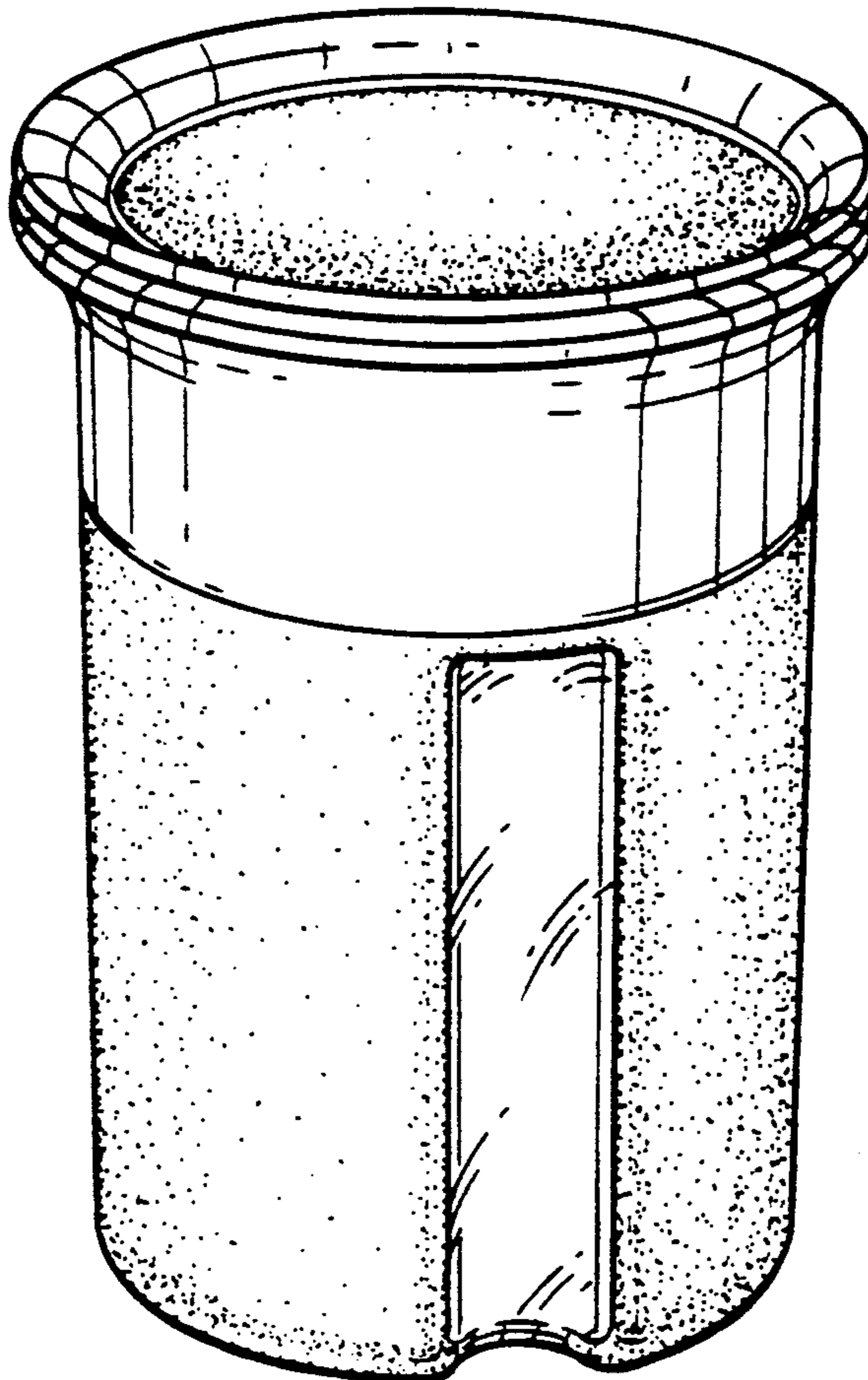

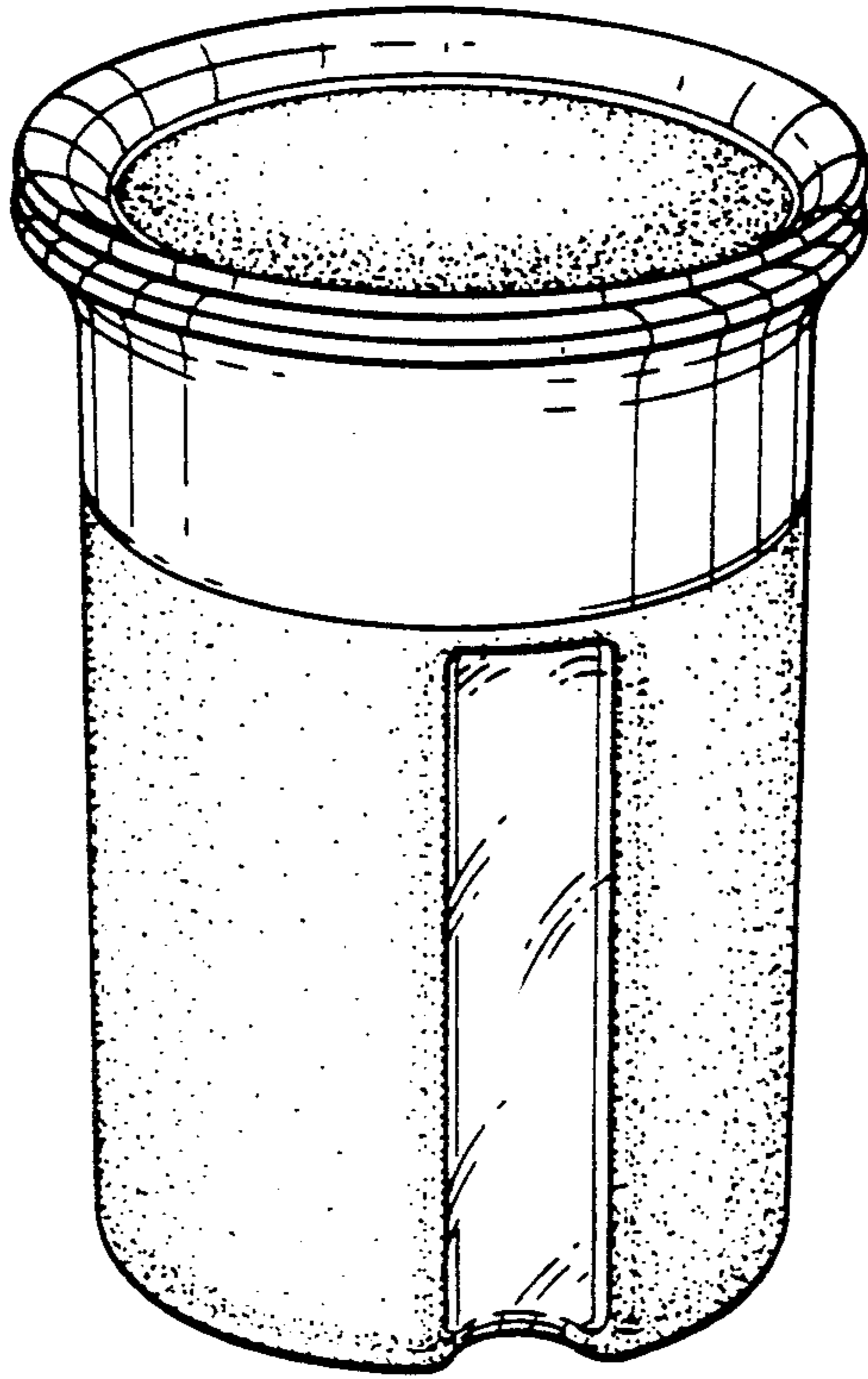

FIG. 1

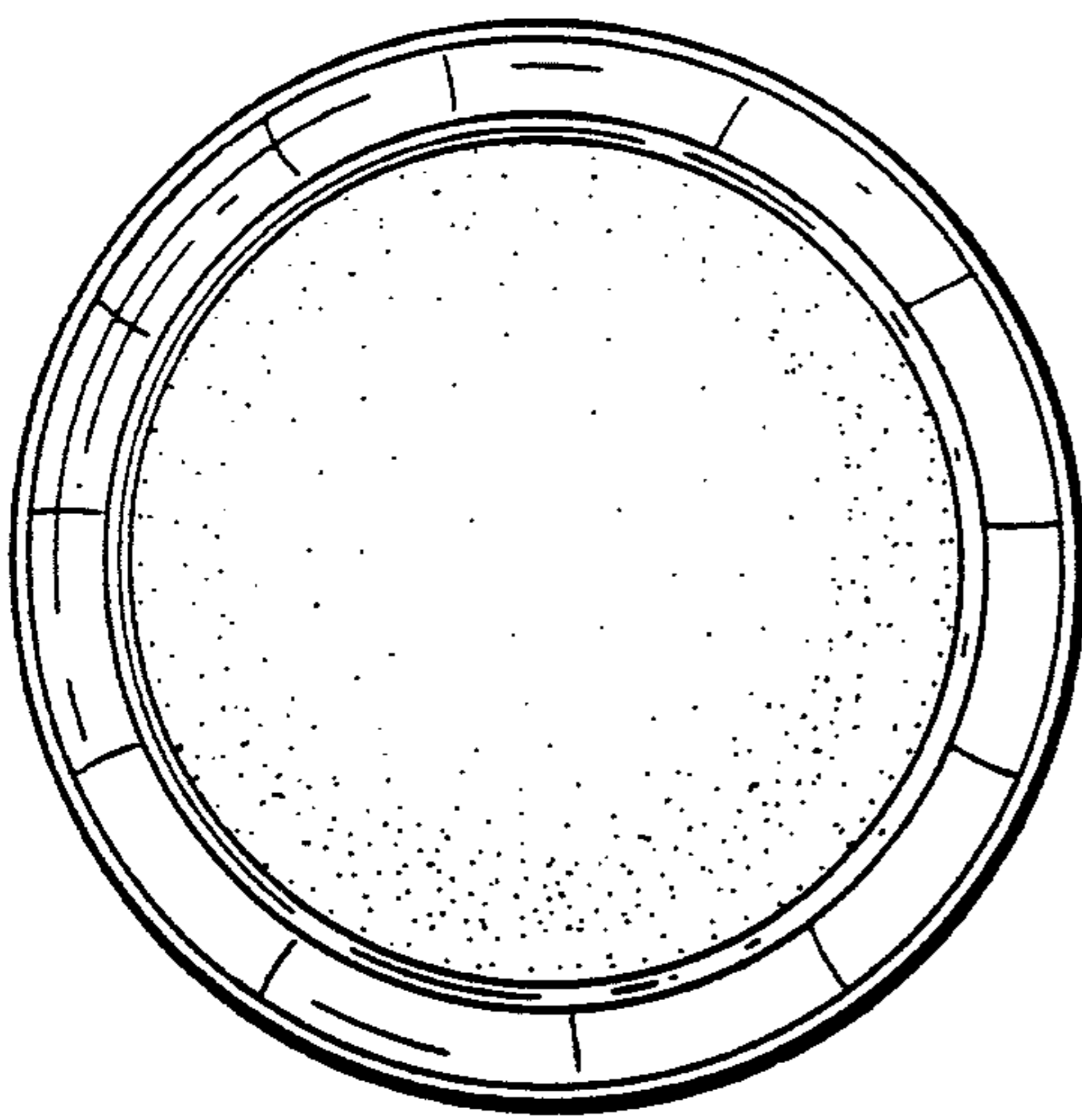

FIG. 2

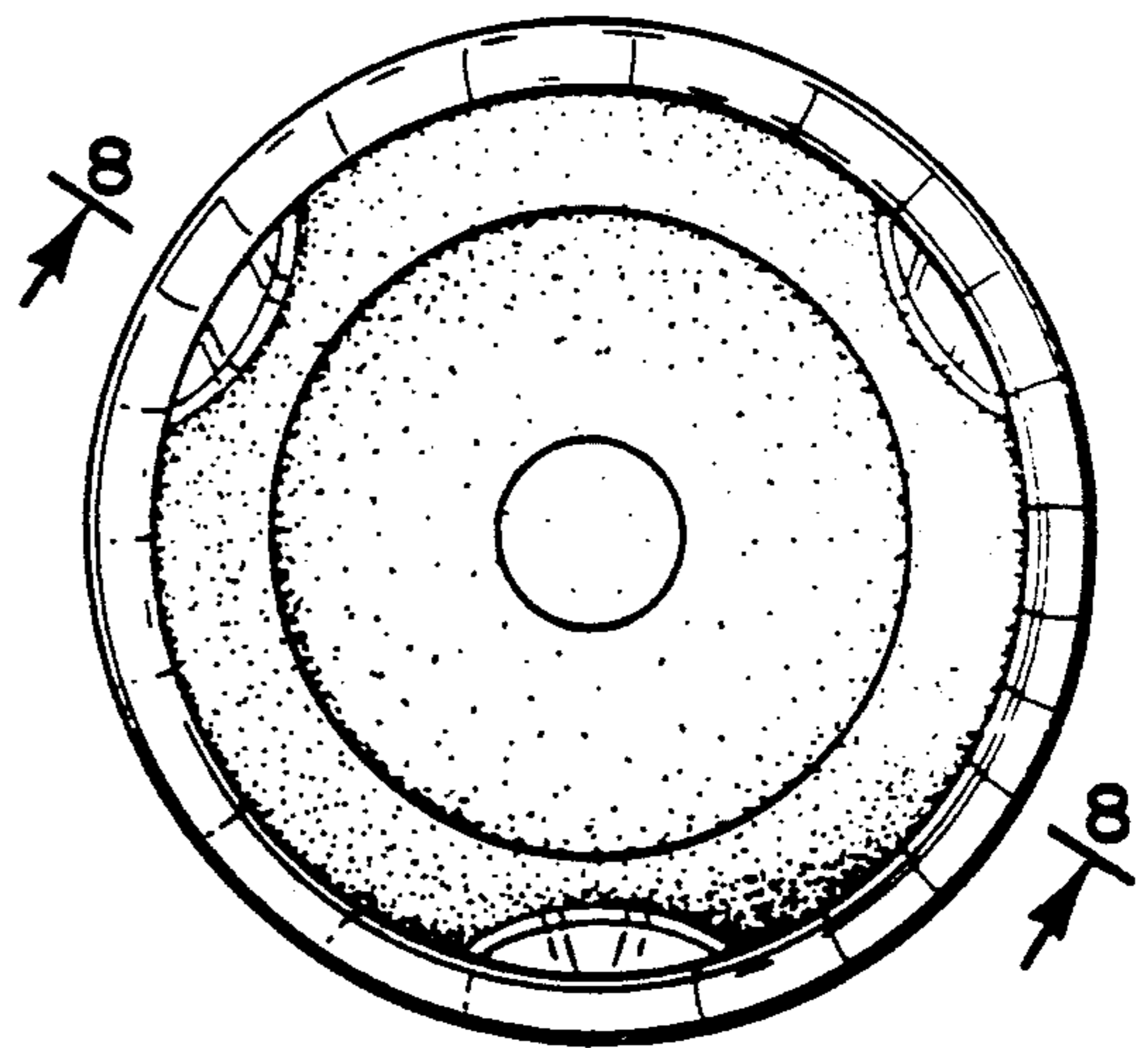

FIG. 3

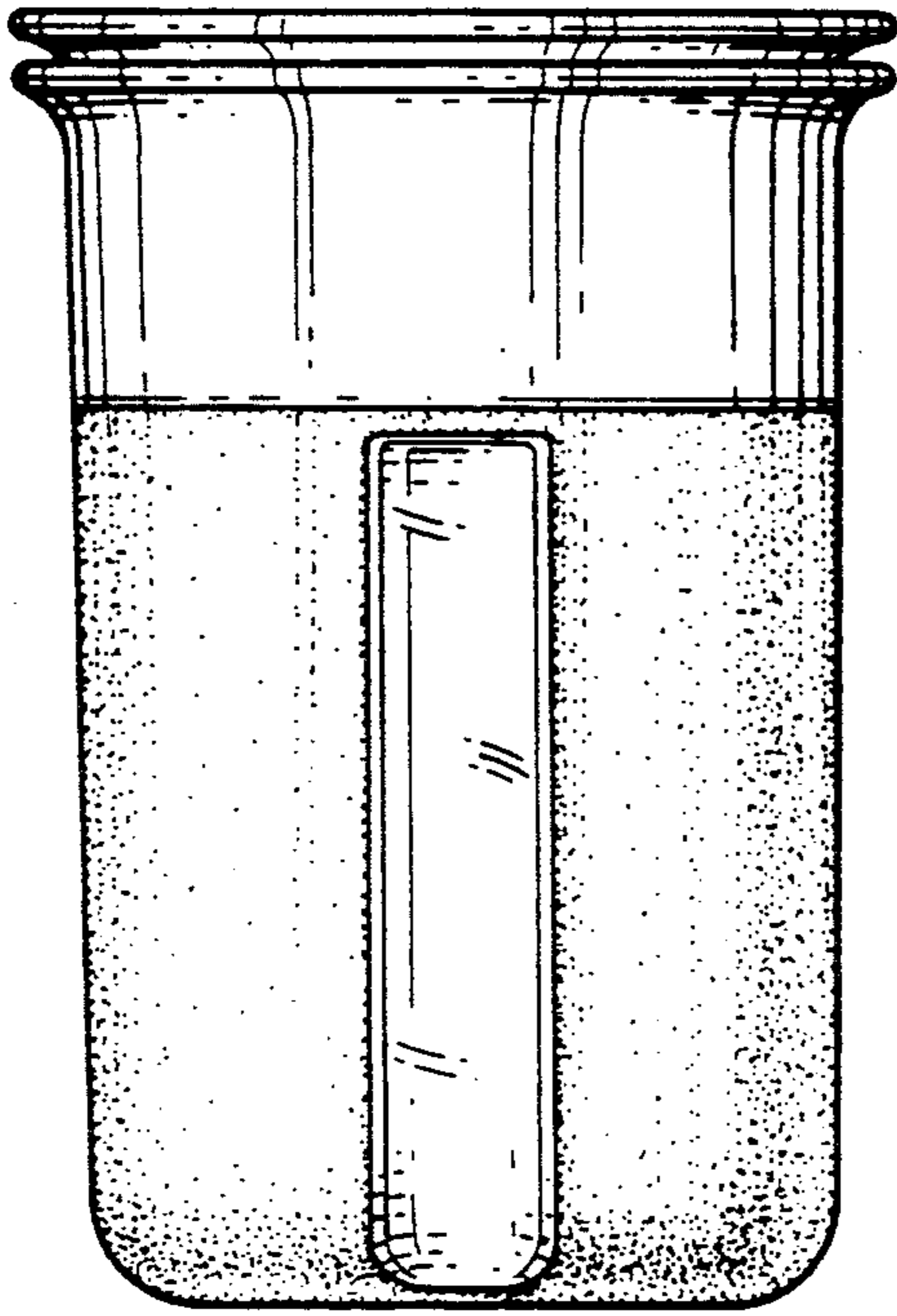

FIG. 4

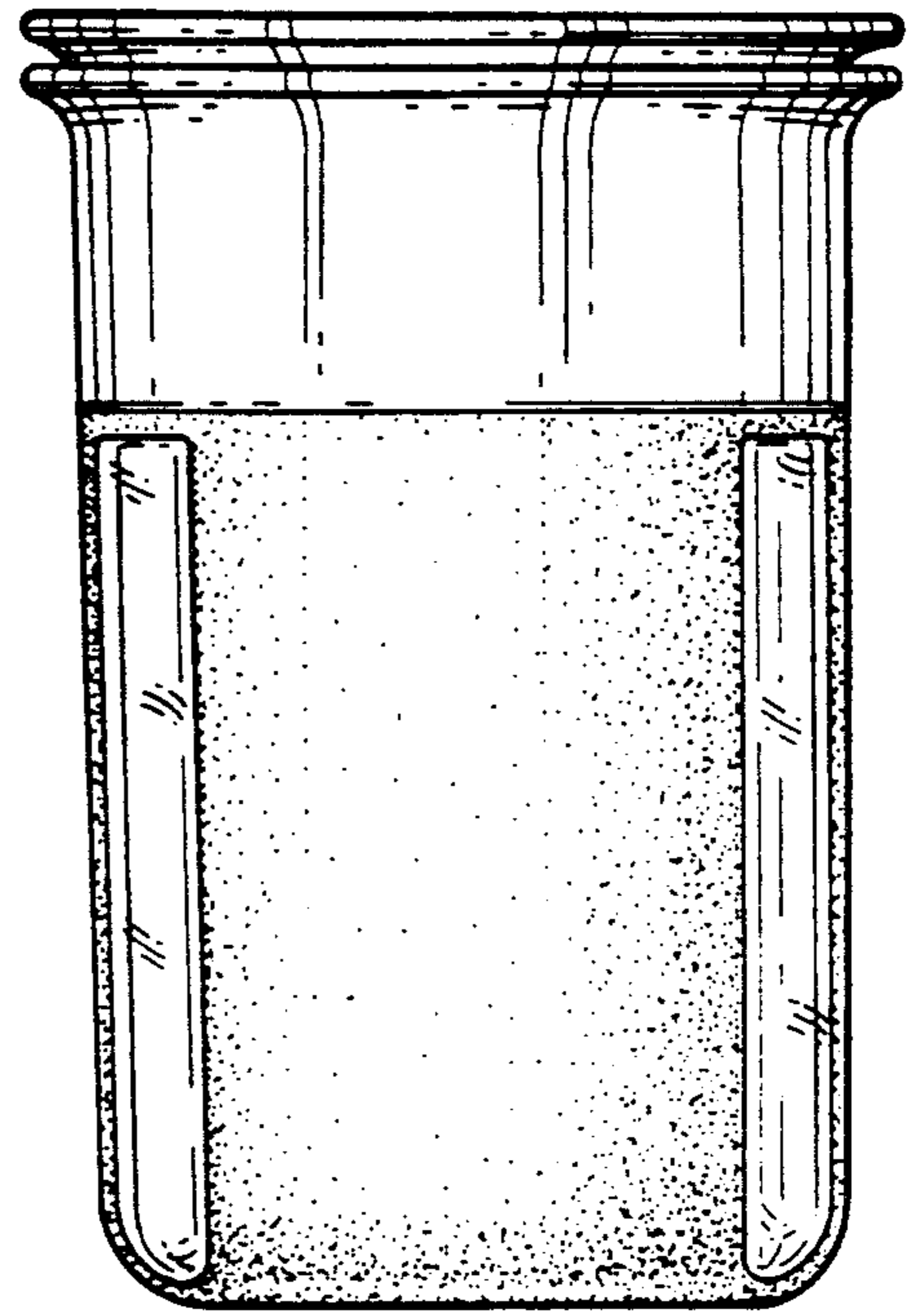

FIG. 5

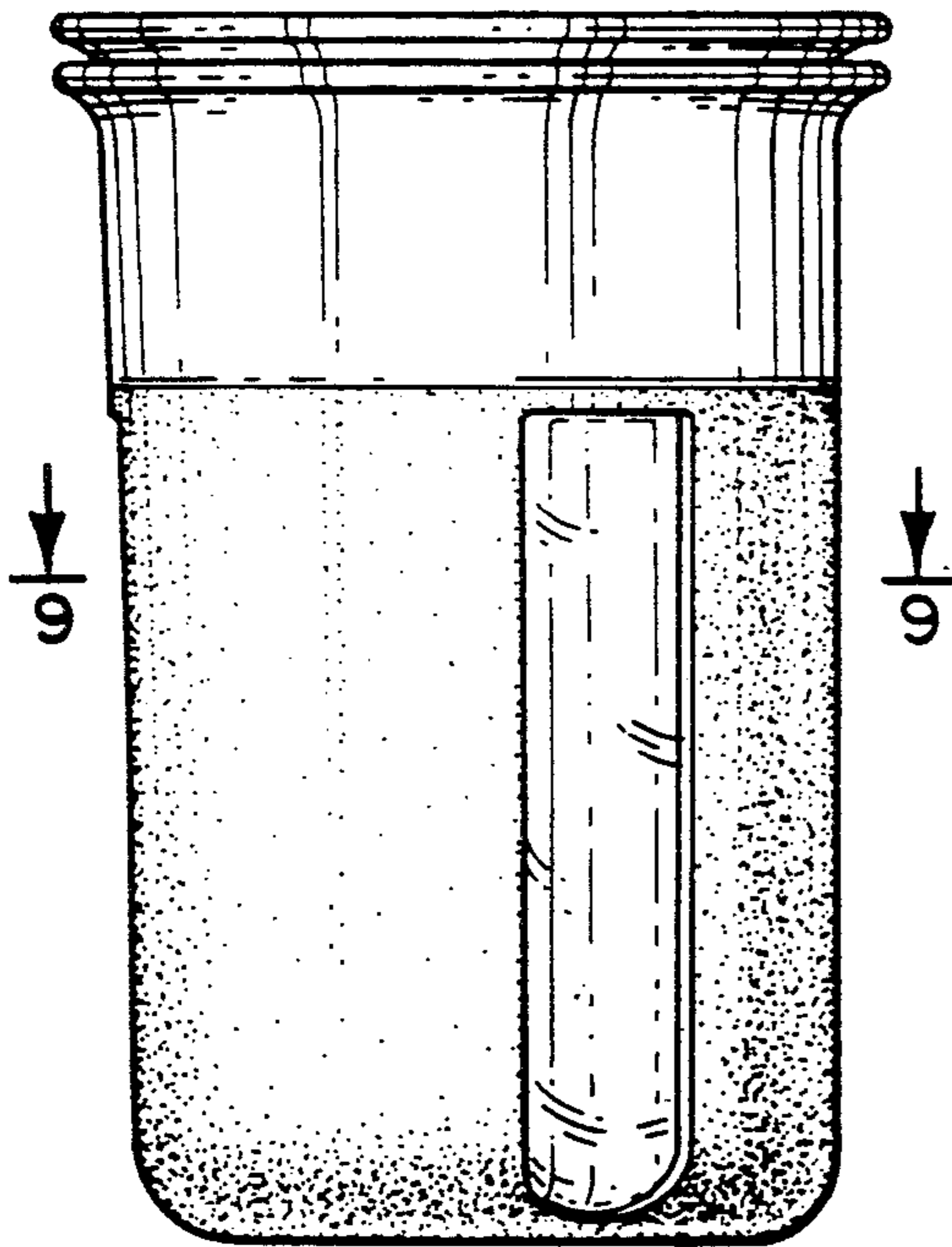

FIG. 6

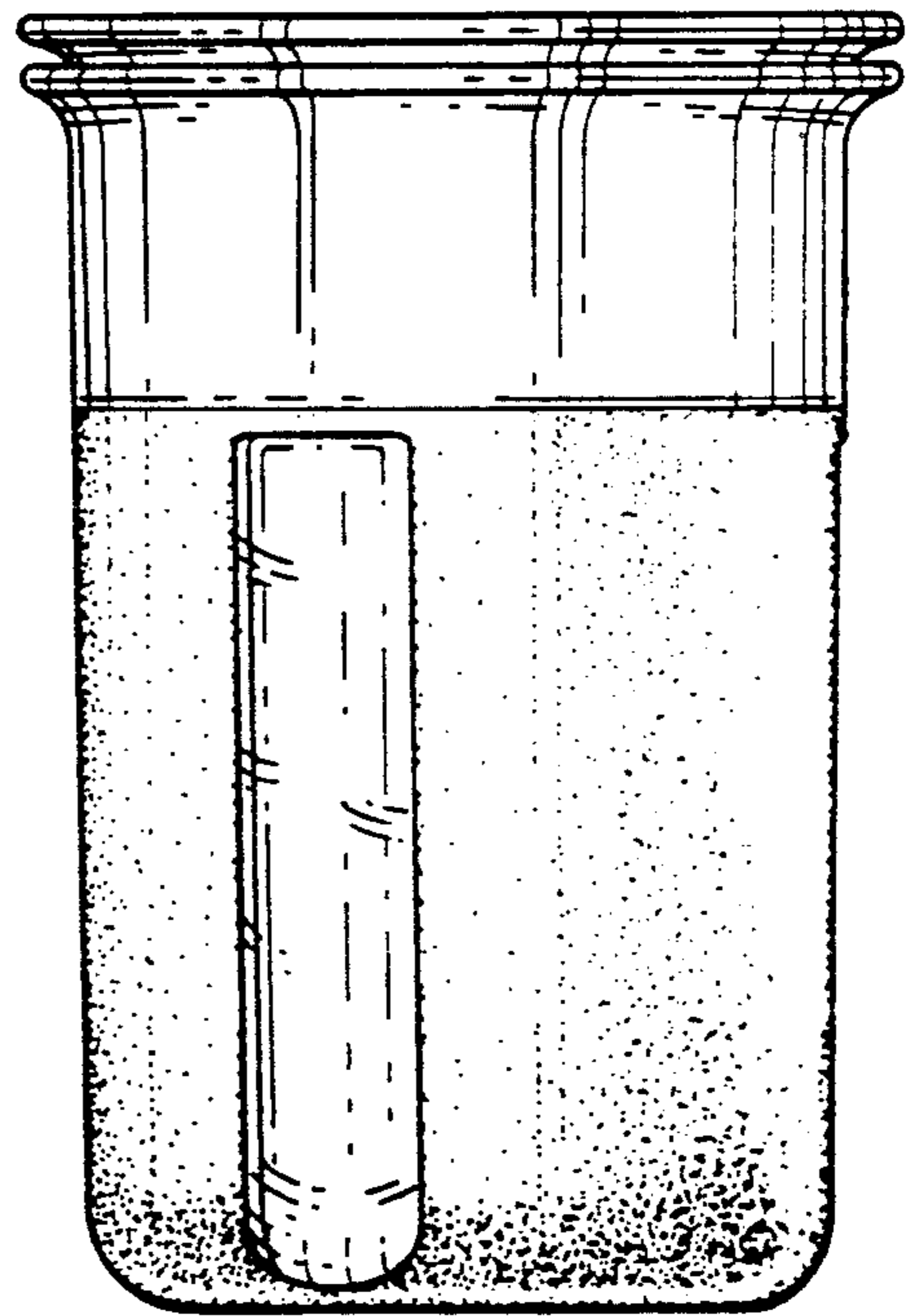

FIG. 7

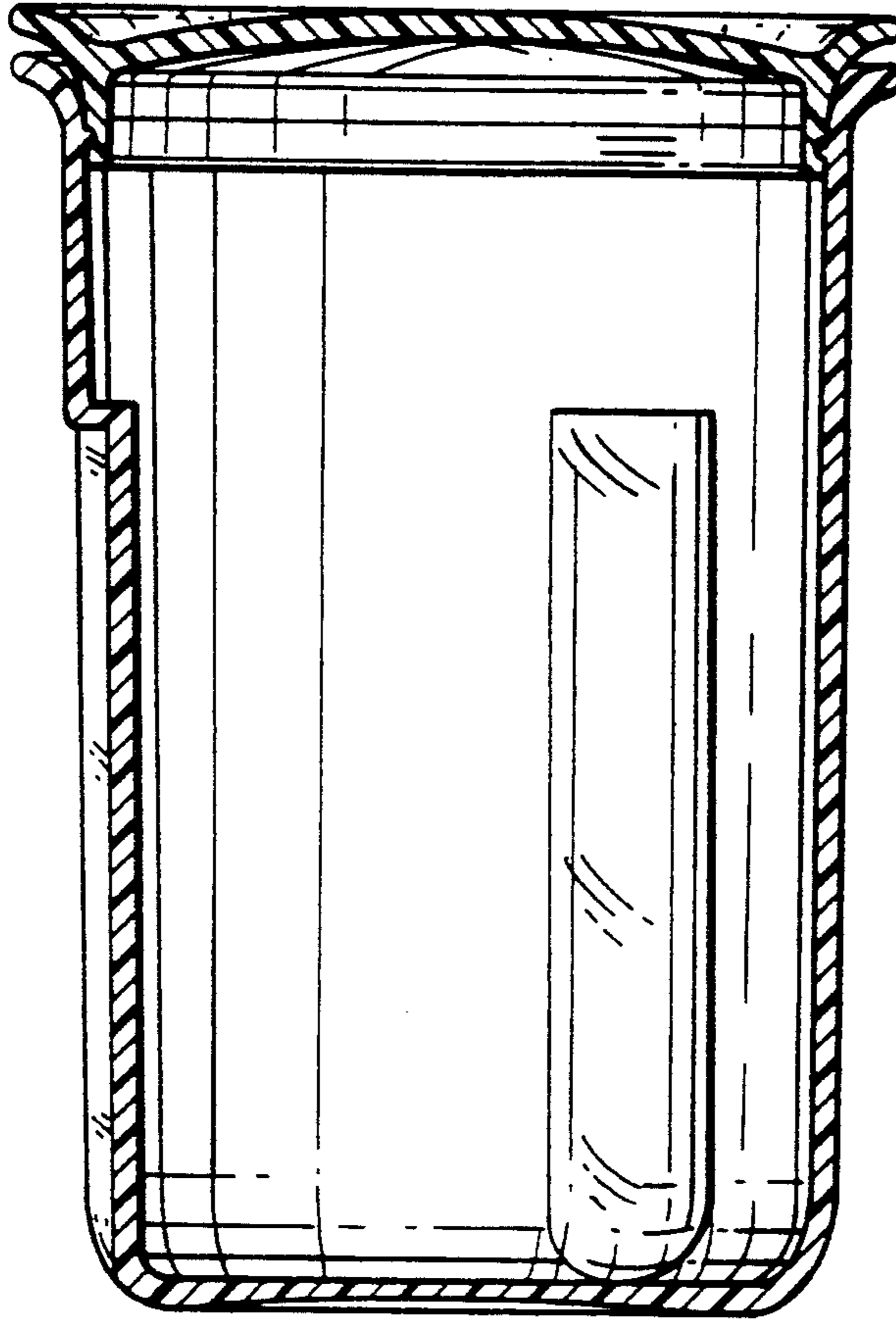

FIG. 8

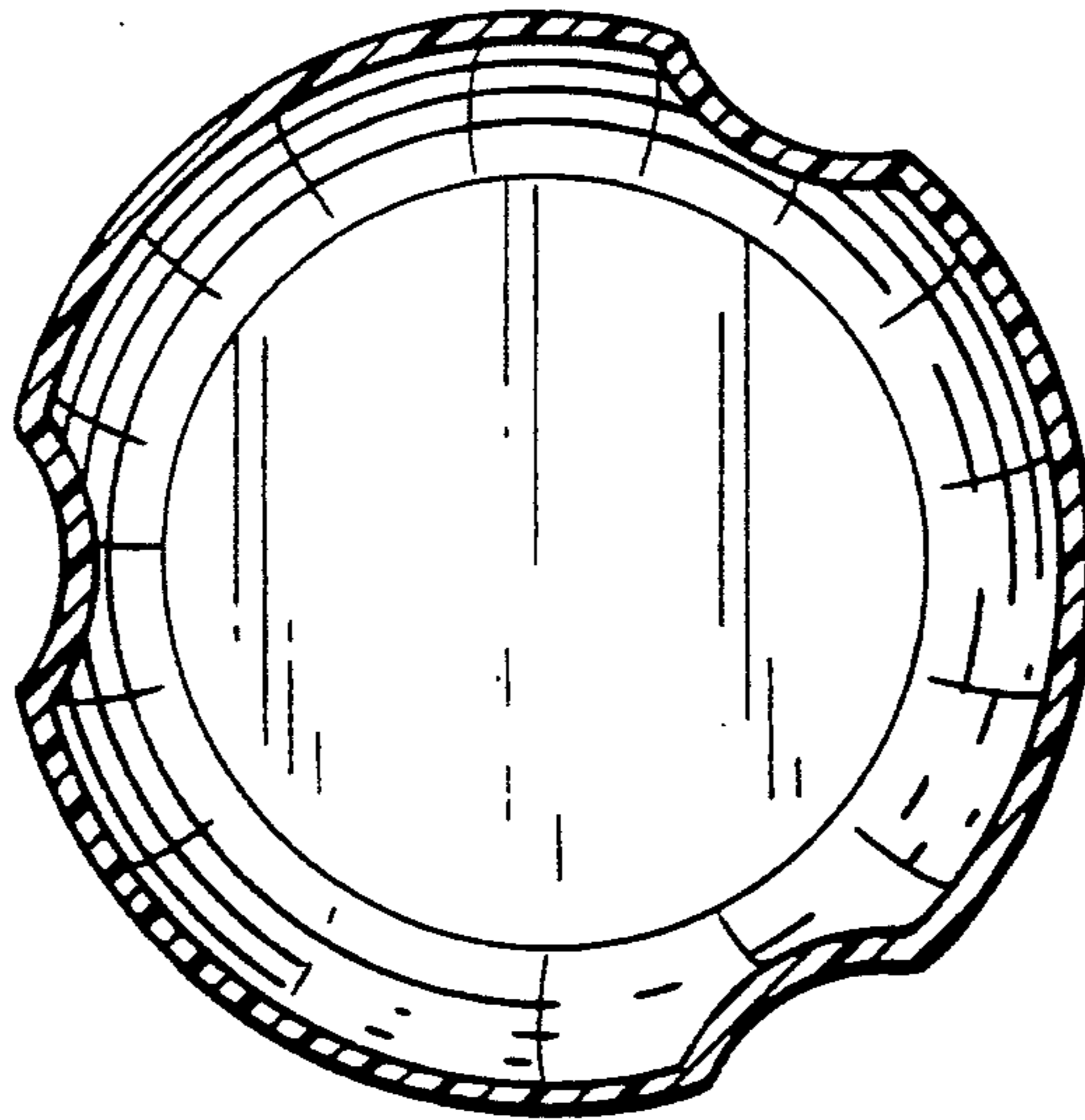

FIG. 9