



US00D327994S

United States Patent [19]

[11] Patent Number: **Des. 327,994**

Carre

[45] Date of Patent: **** Jul. 21, 1992**

[54] **DESK**

[75] Inventor: **Alain Carre, Paris, France**

[73] Assignee: **Okamura Corporation, Yokohama, Japan**

[**] Term: **14 Years**

[21] Appl. No.: **525,181**

[22] Filed: **May 17, 1990**

[30] Foreign Application Priority Data

Nov. 24, 1989 [JP] Japan 1-42353

[52] U.S. Cl. **D6/427; D6/428; D6/484**

[58] Field of Search **D6/422-428, D6/420, 421, 484, 482; 312/194-196, 204; 108/59, 60, 61, 64; 160/135, 351; 52/239, 36**

[56] References Cited

U.S. PATENT DOCUMENTS

D. 148,774	2/1948	Fay	D6/428
D. 166,803	5/1952	Garrett	D6/428
D. 260,836	9/1981	de Polo et al.	D6/484
D. 276,393	11/1984	Foyle	D6/423 X
D. 276,394	11/1984	Foyle	D6/423 X
D. 291,851	9/1987	Salvato	D6/482
D. 313,708	1/1991	Frank	D6/484

FOREIGN PATENT DOCUMENTS

2839770	3/1980	Fed. Rep. of Germany	108/64
3235758	3/1984	Fed. Rep. of Germany	312/195
3727193	2/1989	Fed. Rep. of Germany	312/194
697094	1/1987	Japan	.	
847190	9/1960	United Kingdom	312/194

OTHER PUBLICATIONS

Uchida Office Catalogue, vol. 40, issued Jan. 1, 1989.

Primary Examiner—Carmen H. Vales-Lado
Attorney, Agent, or Firm—Zarley, McKee, Thomte, Voorhees & Sease

[57] CLAIM

The ornamental design for a desk, as shown.

DESCRIPTION

FIG. 1 is a front perspective view of a desk showing my new design;
 FIG. 2 is a rear perspective view thereof;
 FIG. 3 is a top plan view thereof;
 FIG. 4 is a front elevational view thereof;
 FIG. 5 is a bottom plan view thereof;
 FIG. 6 is a rear elevational view thereof;
 FIG. 7 is a right side elevational view thereof;
 FIG. 8 is a left side elevational view thereof; and,
 FIG. 9 is an enlarged sectional view taken along line 9-9 of FIG. 3.

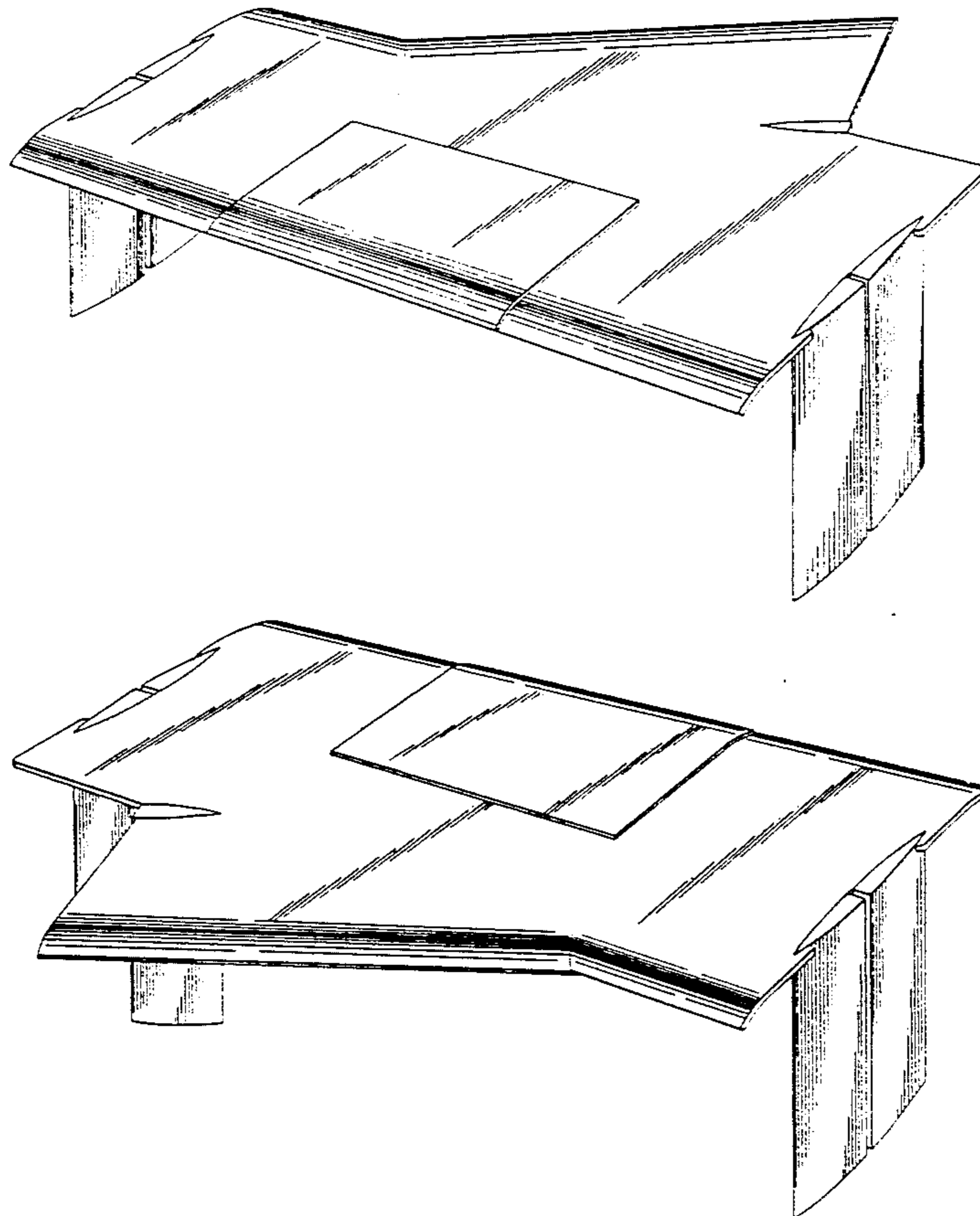

FIG. 1

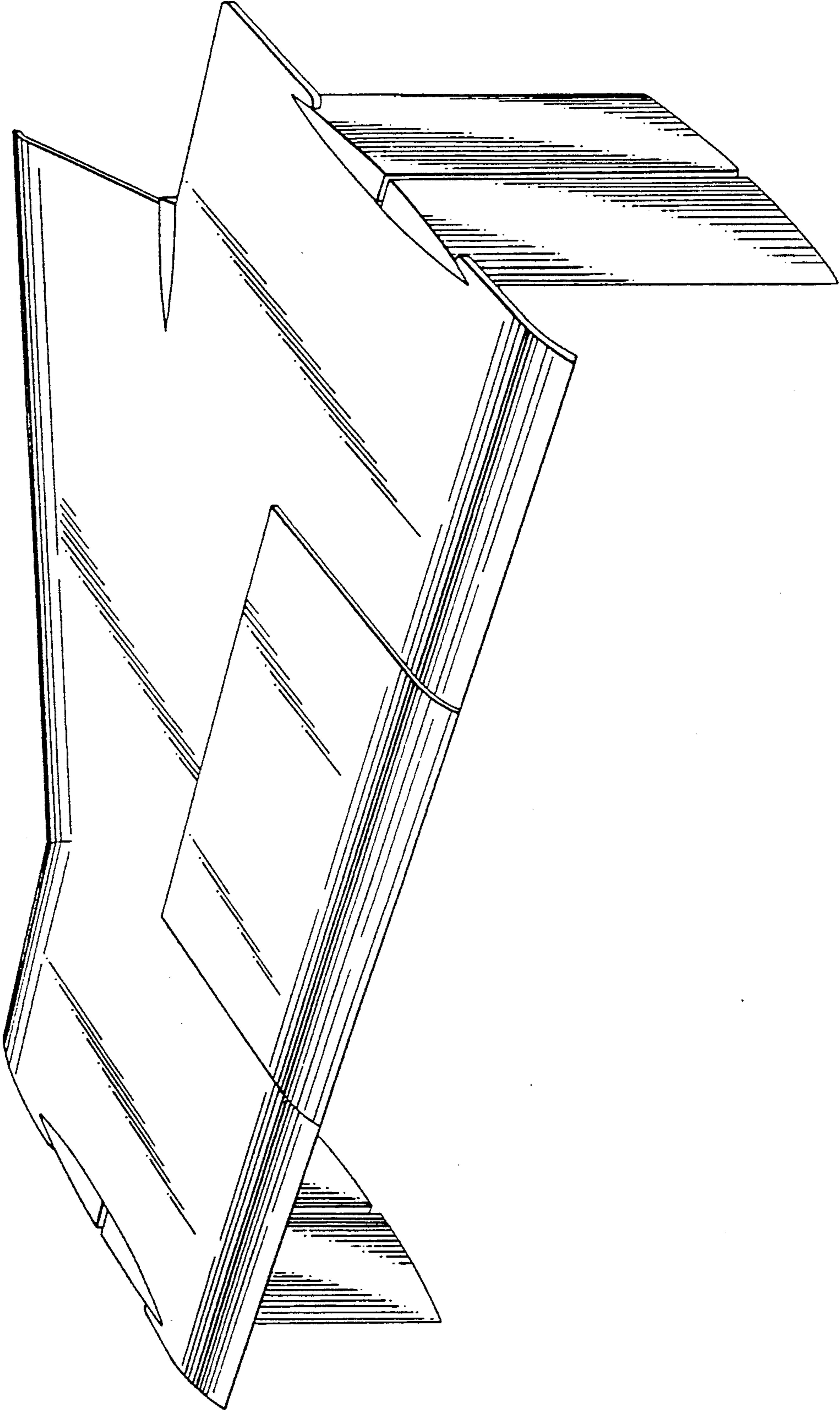

FIG. 2

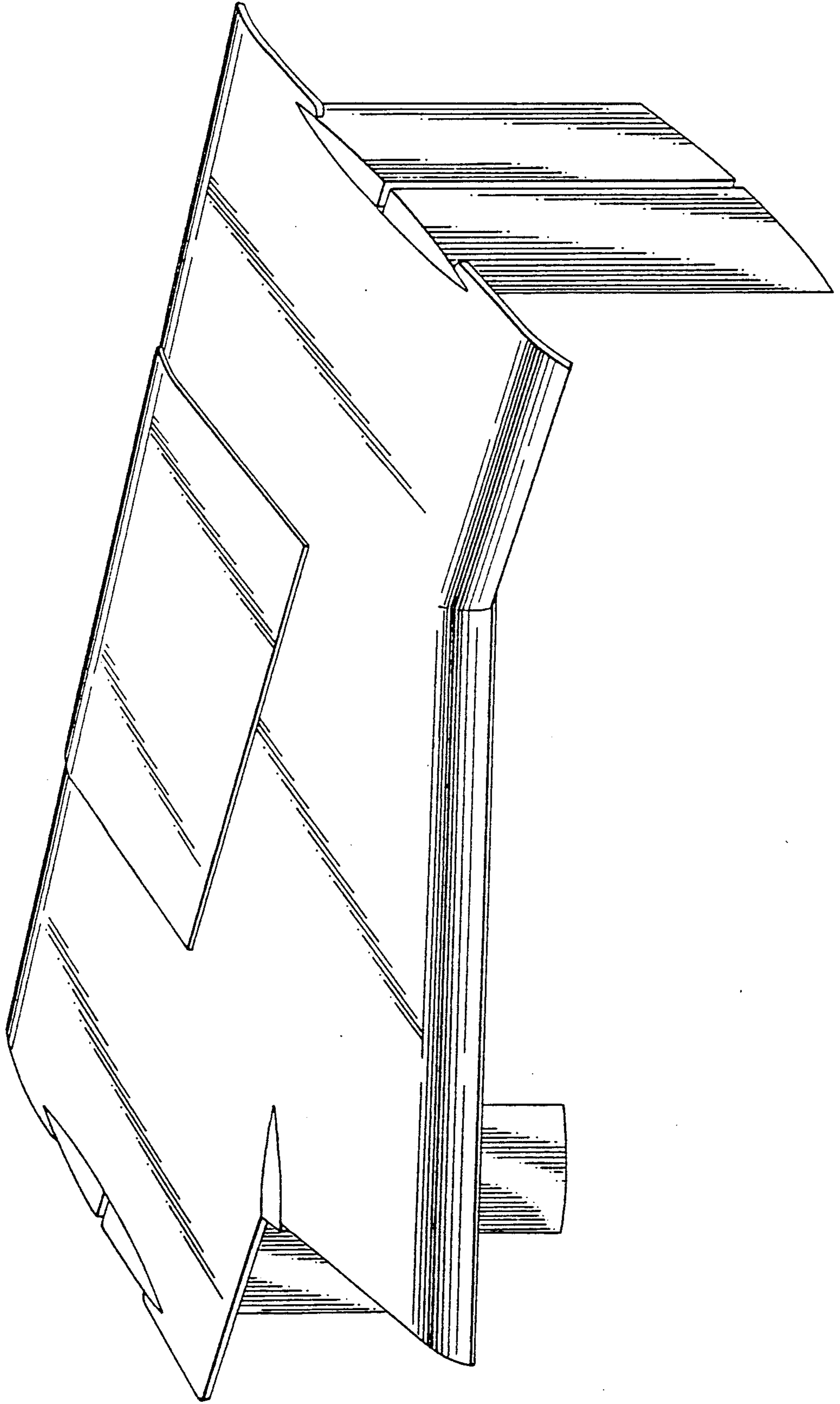

FIG. 3

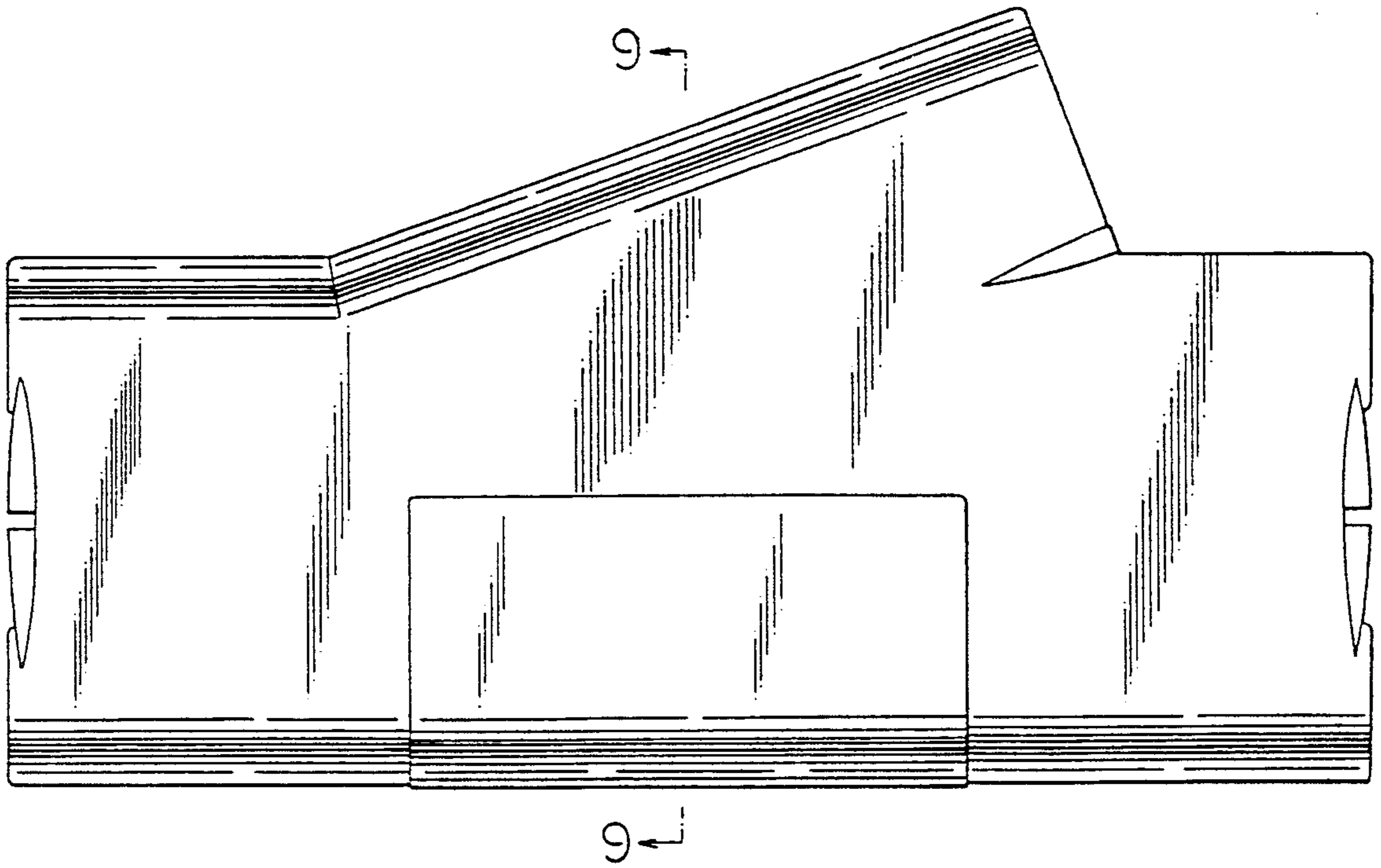

FIG. 4

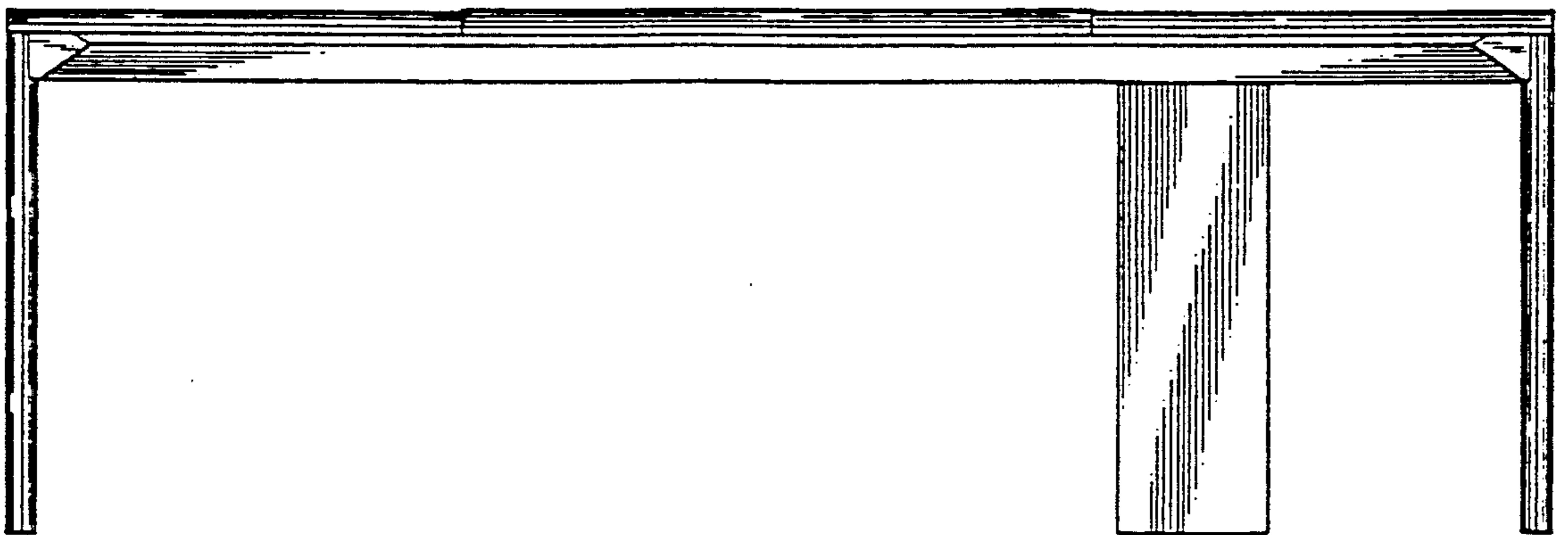

FIG. 5

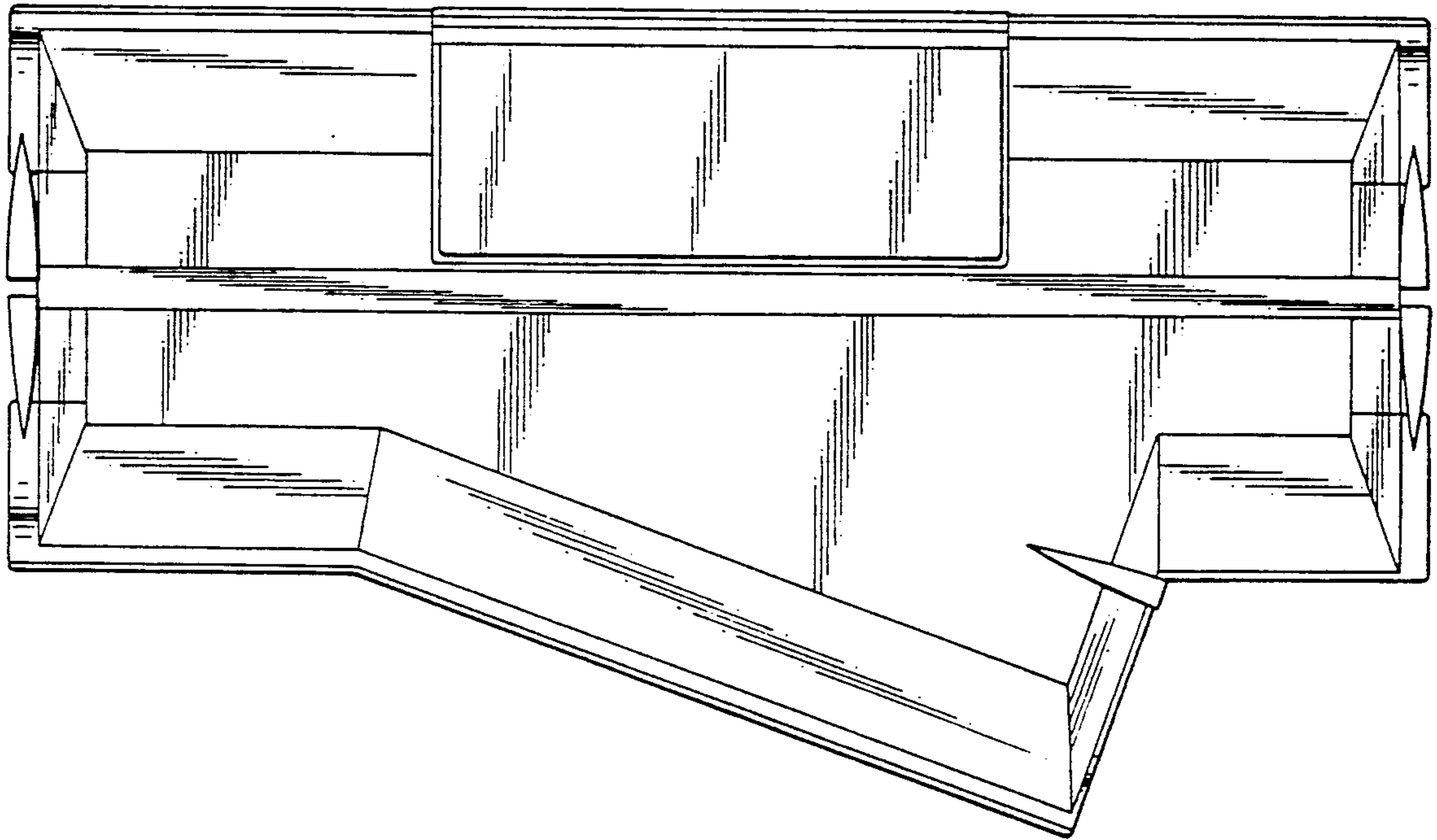

FIG. 6

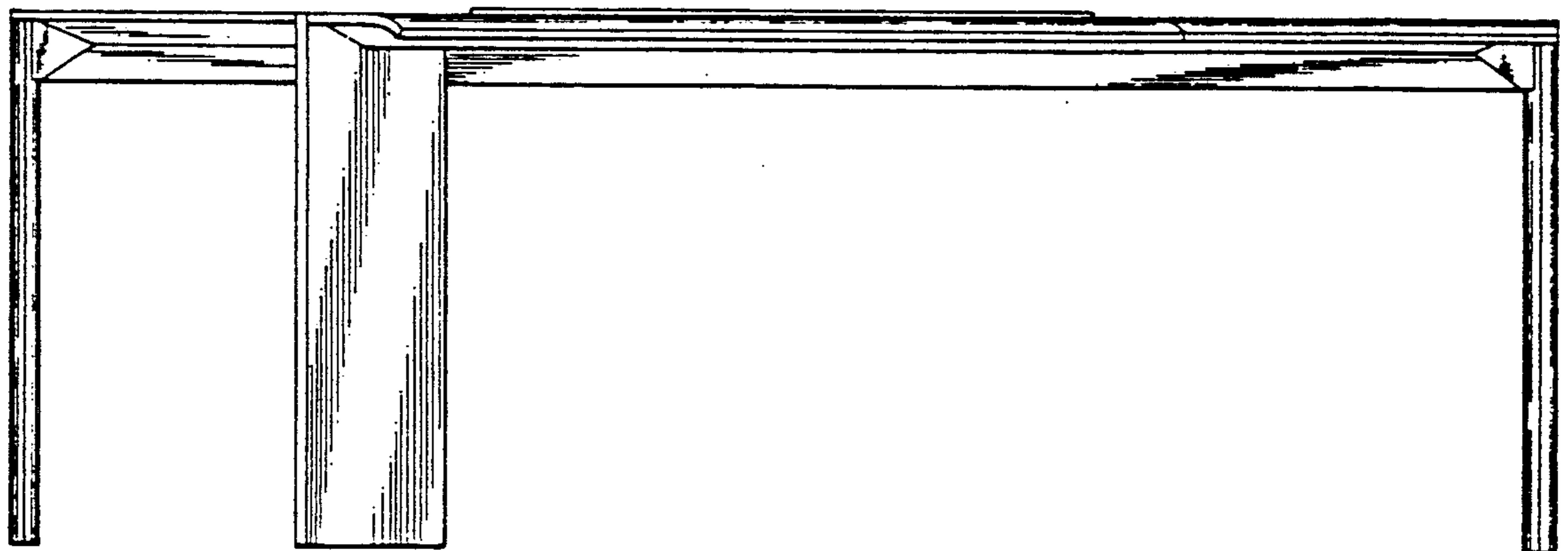

FIG. 7

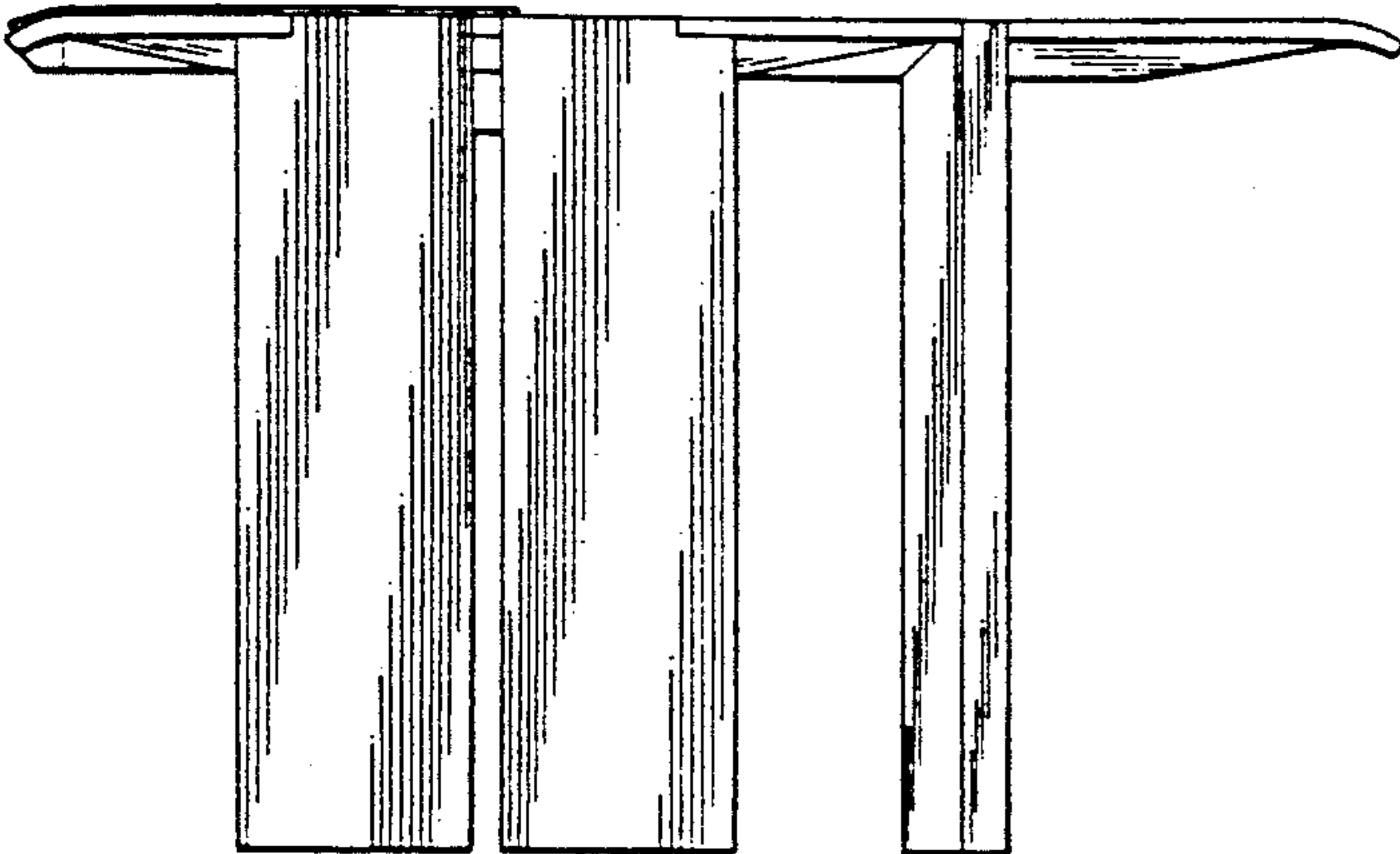

FIG. 8

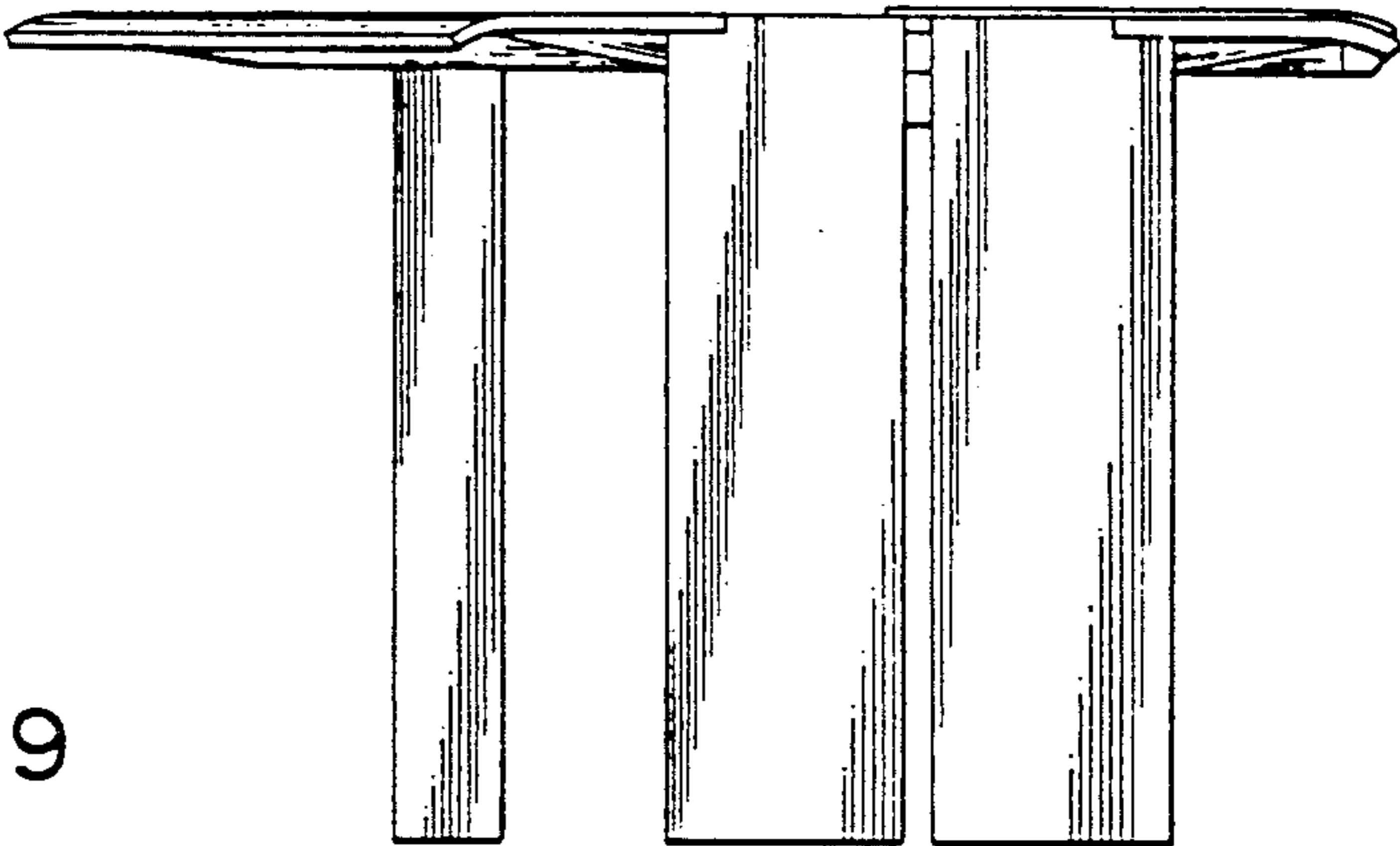

FIG. 9

