



US00D327970S

United States Patent [19]

[11] Patent Number: **Des. 327,970**

Watanabe et al.

[45] Date of Patent: **** Jul. 14, 1992**

[54] **STACKABLE CONTAINER FOR BOTTLES**

5,038,961 8/1991 Watanabe et al. 220/519

[75] Inventors: **Makoto Watanabe, Tokyo; Yasuzi Kobayashi, Shizuoka, both of Japan**

FOREIGN PATENT DOCUMENTS

[73] Assignee: **Yazaki Industrial Chemical Co., Ltd., Japan**

306074 3/1989 European Pat. Off. 206/203

[**] Term: **14 Years**

OTHER PUBLICATIONS

[21] Appl. No.: **490,277**

Food Processing Industry, Nov. 1970, p. 118, bottom left of the page.

[22] Filed: **Mar. 8, 1990**

LewisSystems, Jan. 1983, p. 18, top left of the page.

[30] Foreign Application Priority Data

Primary Examiner—Bernard Ansher
Assistant Examiner—Prabhakar Deshmukh

Sep. 11, 1989 [JP] Japan 1-33216

[52] U.S. Cl. **D34/40; D9/341**

[57] CLAIM

[58] Field of Search D34/40-46;
D9/424, 425, 427, 429, 341, 337; 206/507, 427,
509, 518, 512, 513, 514, 203, 503, 821; 220/507,
512, 514, 519, 509, 500, 516

The ornamental design for stackable container for bottles, as shown and described.

DESCRIPTION

[56] References Cited

U.S. PATENT DOCUMENTS

D. 152,907	3/1949	Richards	D34/45
D. 208,111	7/1967	Vidal	D34/45
D. 289,938	5/1987	Warwick	D34/45
D. 311,624	10/1990	O'Leary et al.	D34/40
3,363,802	1/1968	Cornelius	206/203
4,700,836	10/1987	Hammett	206/427
4,928,841	5/1990	Arthurs	206/203 X

FIG. 1 is a top perspective view of a stackable container for bottles showing our new design; FIG. 2 is a bottom perspective view thereof; FIG. 3 is a top plan view thereof; FIG. 4 is a bottom plan view thereof; FIG. 5 is a front elevation thereof; the rear elevation being a mirror image thereof; FIG. 6 is a left side elevation thereof; the right side elevation being a mirror image thereof; and, FIG. 7 is a fragmentary sectional elevation thereof; taken along line 7—7 of FIG. 3.

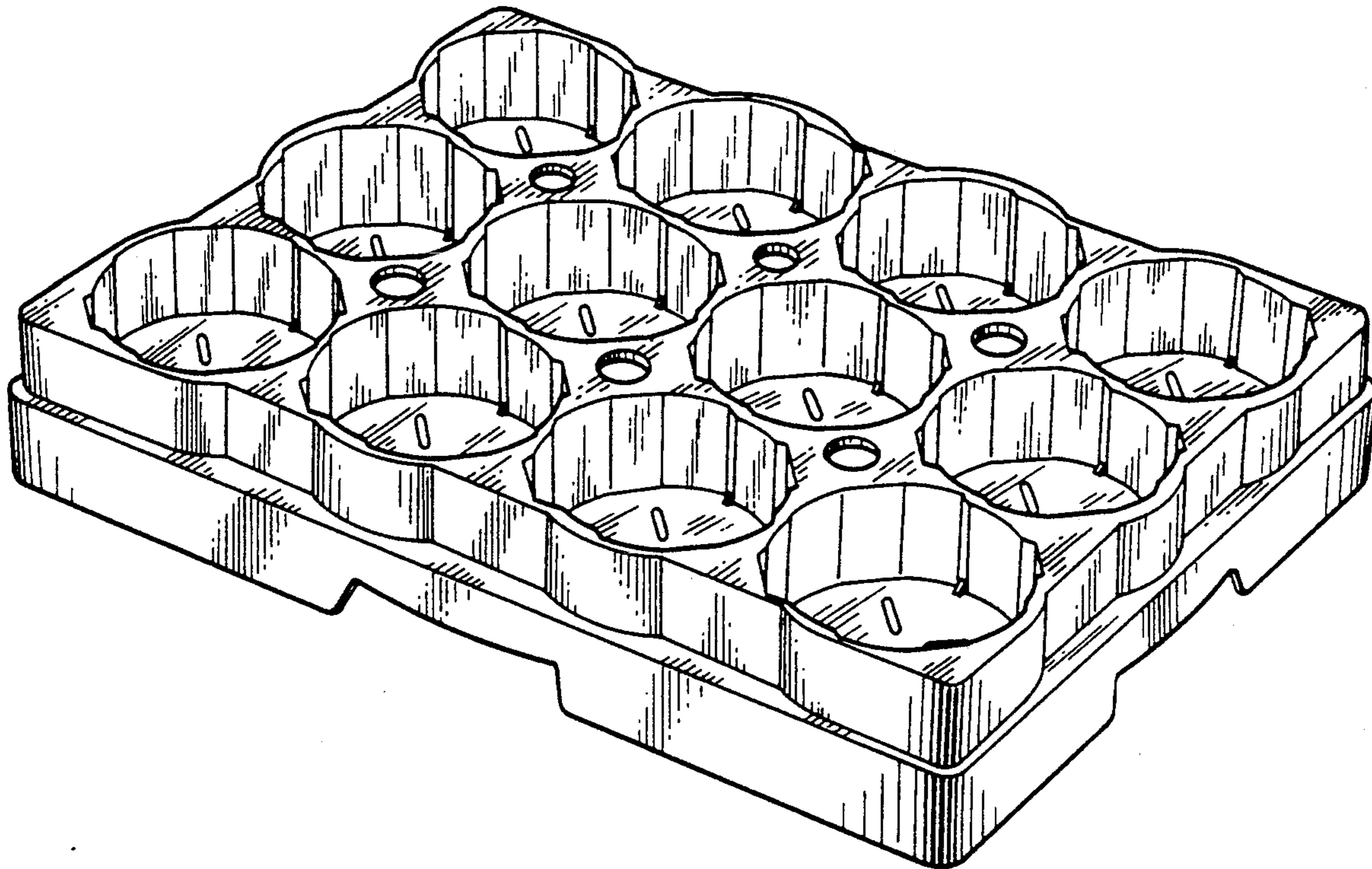

FIG. 1

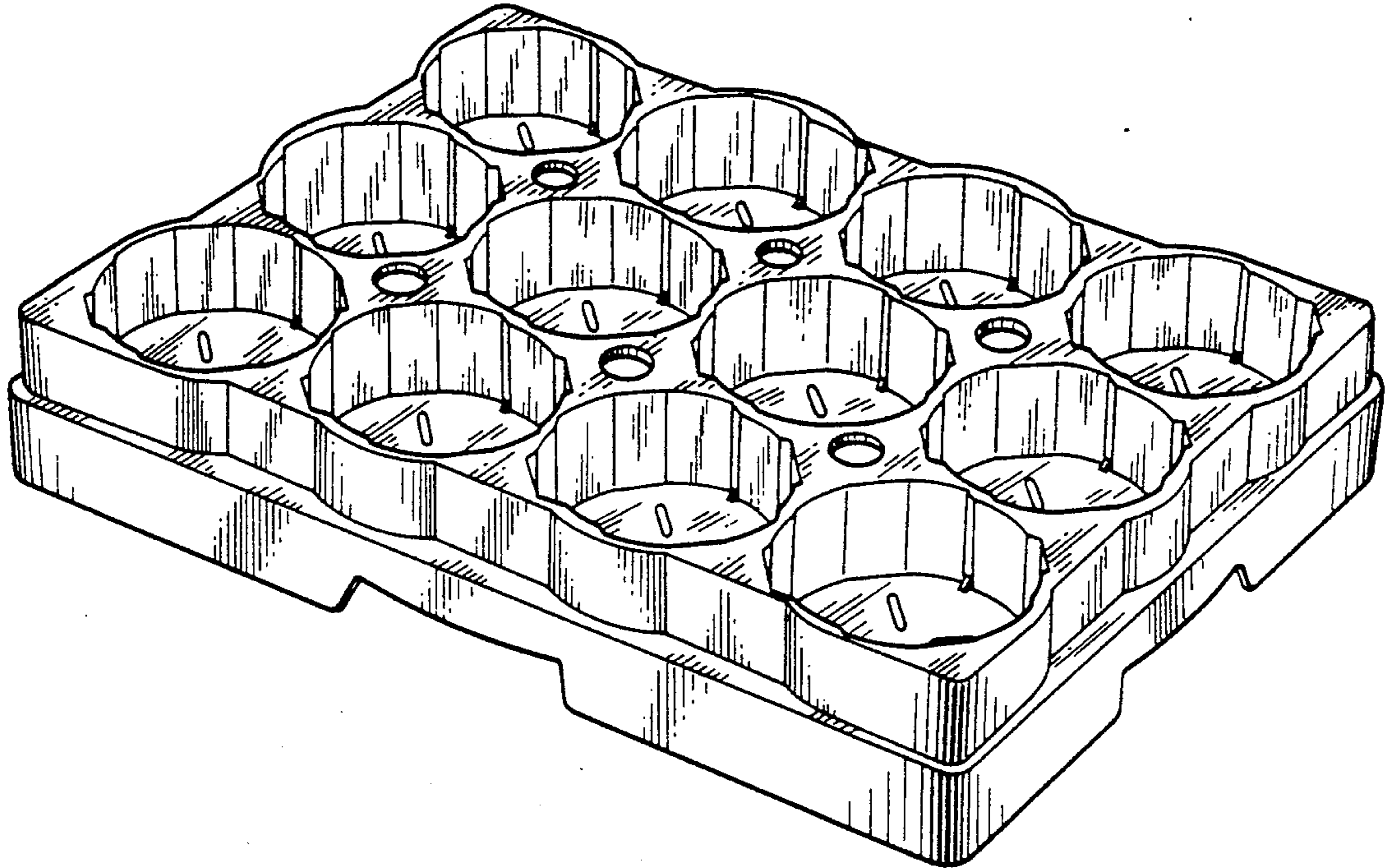

FIG. 2

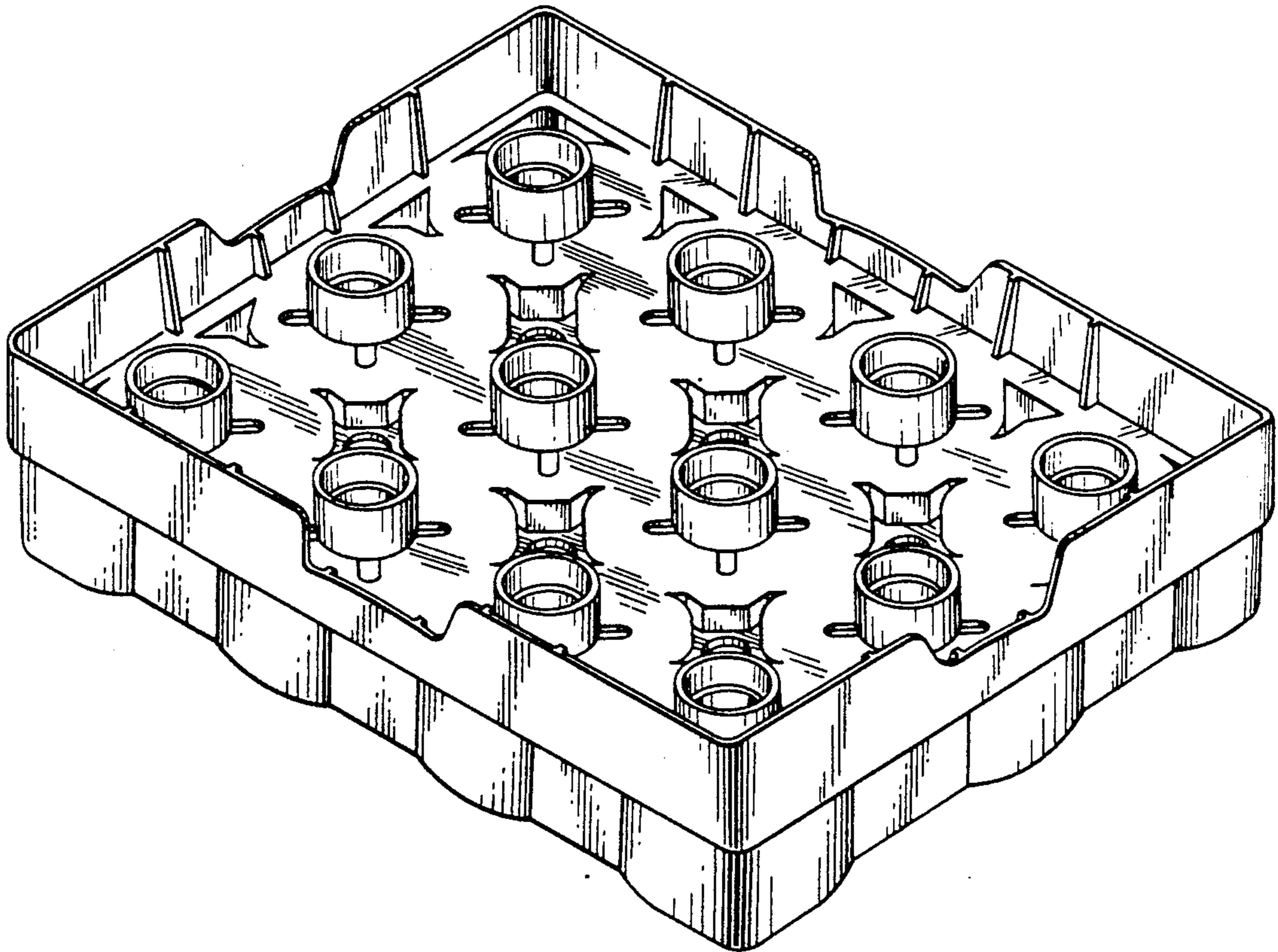

FIG. 3

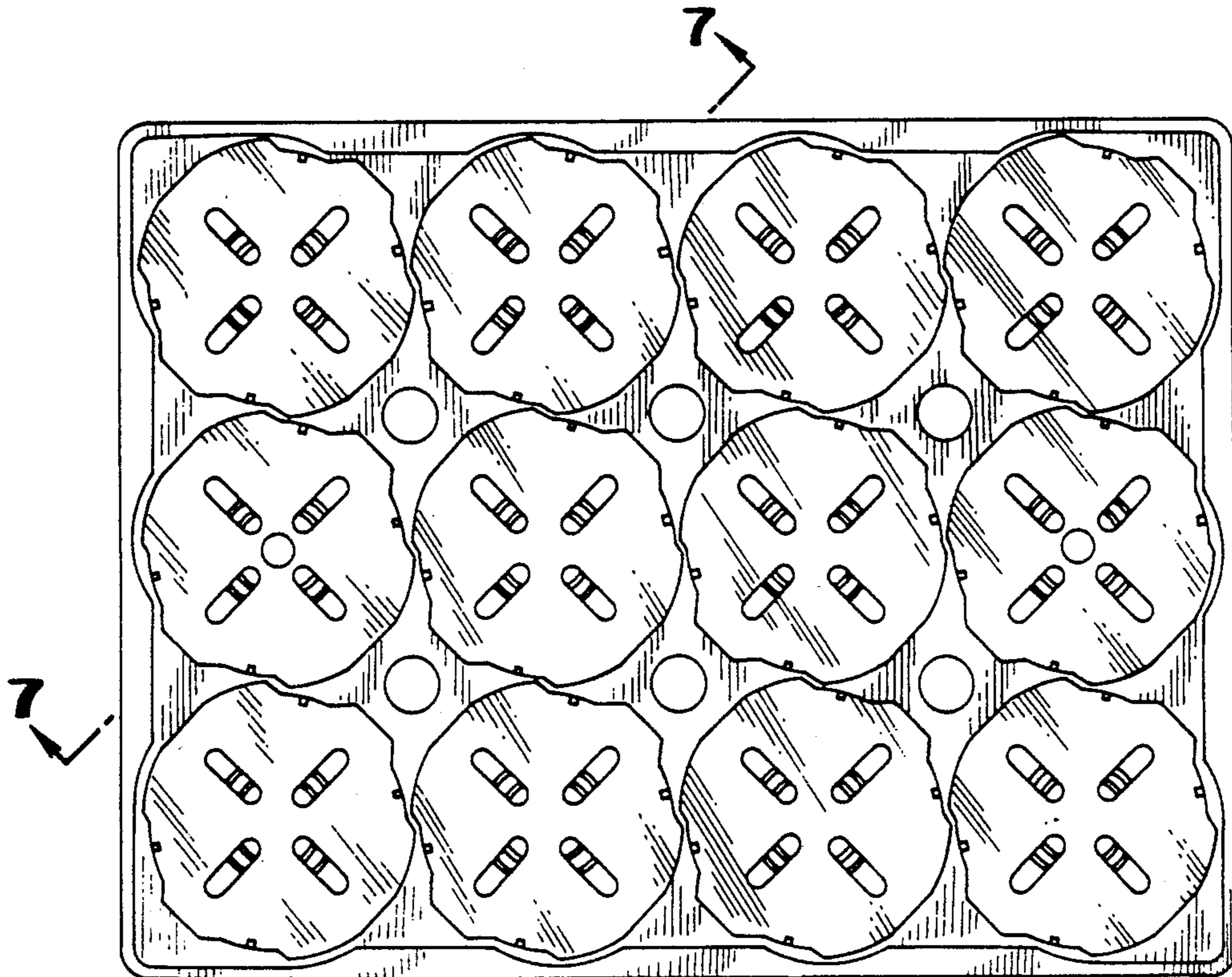

FIG. 4

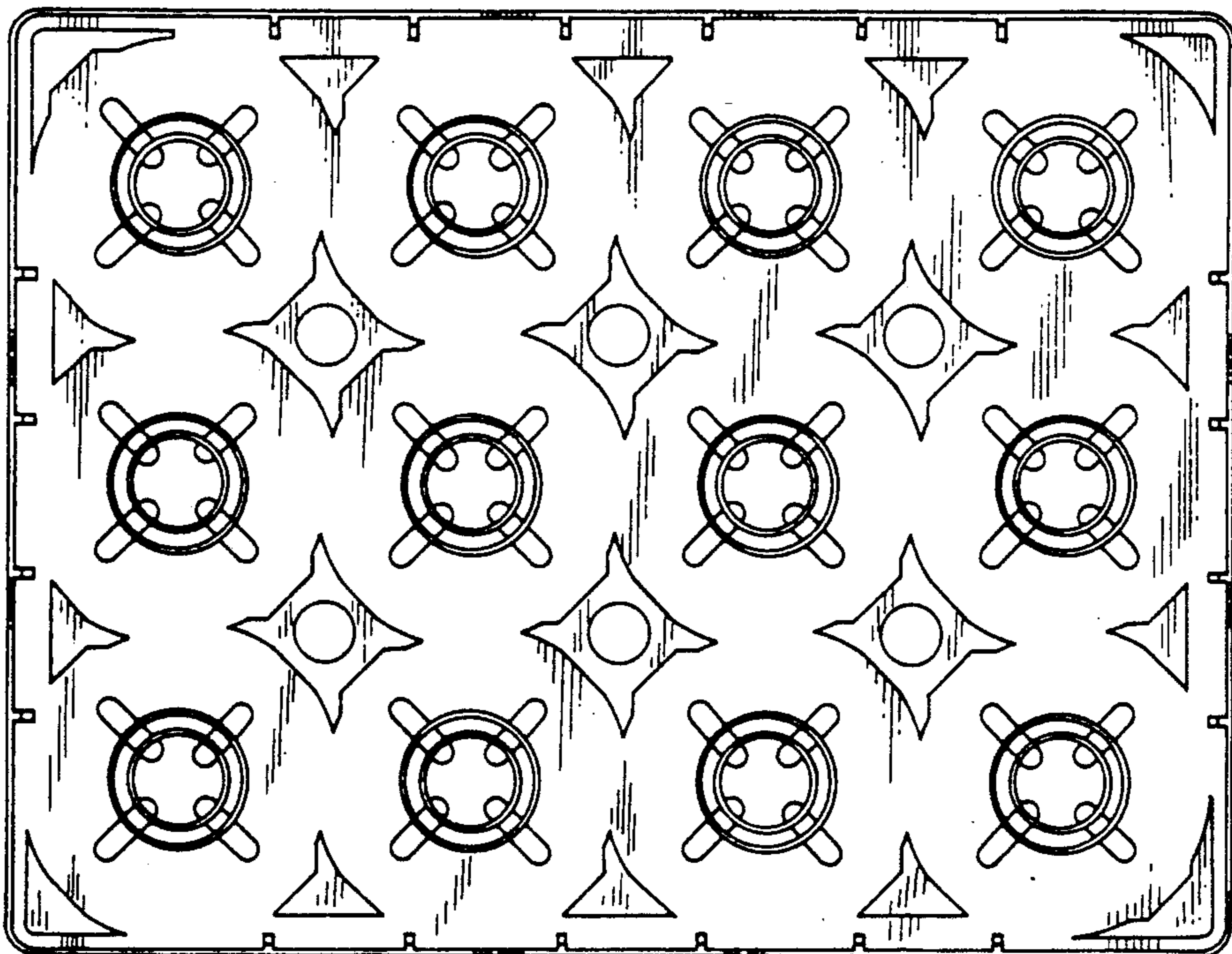

FIG. 5

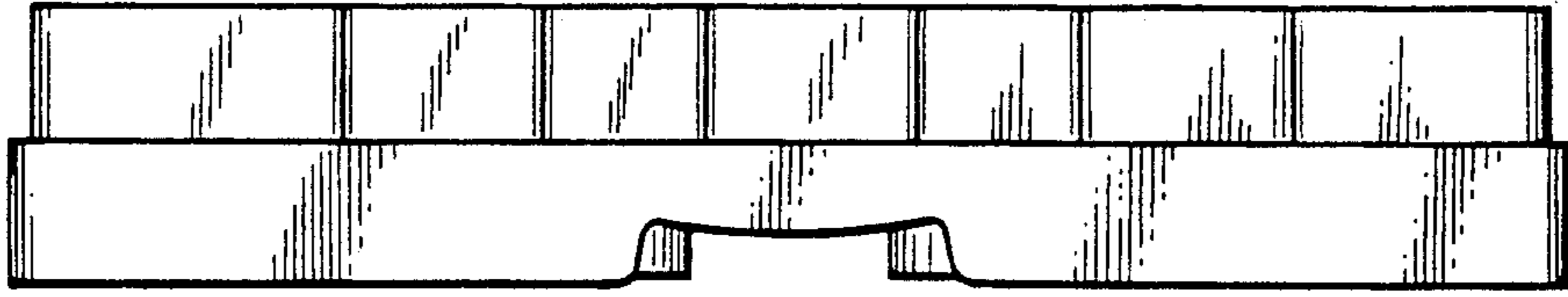

FIG. 6

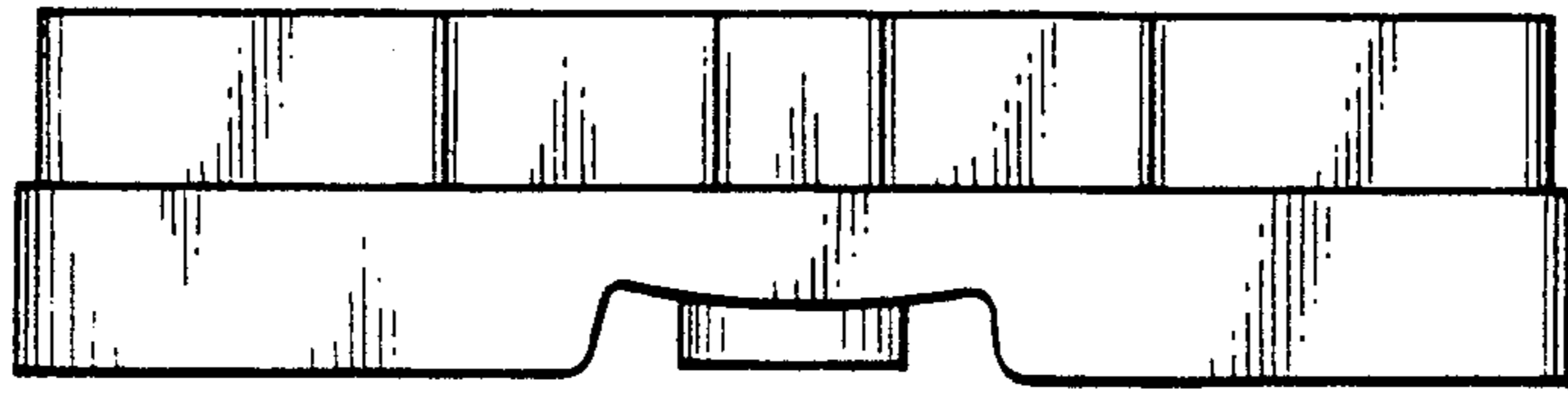

FIG. 7

