



US00D327812S

# United States Patent [19]

Thomas et al.

[11] Patent Number: Des. 327,812

[45] Date of Patent: \*\* Jul. 14, 1992

[54] FOOD BLENDER VESSEL

[75] Inventors: Richard K. Thomas, Elk Grove Village; Eleanor A. Bast, West Chicago, both of Ill.

[73] Assignee: Sunbeam Corporation, Downers Grove, Ill.

[\*\*] Term: 14 Years

[21] Appl. No.: 249,522

[22] Filed: Sep. 23, 1988

[52] U.S. Cl. .... D7/413; D7/415

[58] Field of Search ..... D7/378, 412-415, D7/384, 376, 377, 383

[56] References Cited

### U.S. PATENT DOCUMENTS

- D. 204,924 5/1966 Di Sesa ..... D7/378
- D. 209,493 12/1967 Le Sueur et al. .... D7/378
- D. 220,416 4/1971 Folden ..... D7/413

D. 242,302 11/1976 Madl ..... D7/413

Primary Examiner—Winifred E. Herrmann  
Attorney, Agent, or Firm—Arnold B. Silverman; David V. Radack

### [57] CLAIM

The ornamental design for a food blender vessel, as shown and described.

### DESCRIPTION

FIG. 1 is a front perspective view of a food blender vessel embodying our new design; FIG. 2 is a top plan view thereof; FIG. 3 is a front elevational view thereof; FIG. 4 is a rear elevational view thereof; FIG. 5 is a right side elevational view thereof; FIG. 6 is a bottom plan view thereof; FIG. 7 is a fragmentary sectional view taken substantially on line 7—7 of FIG. 5; and, FIG. 8 is a fragmentary sectional view taken on line 8—8 of FIG. 7.

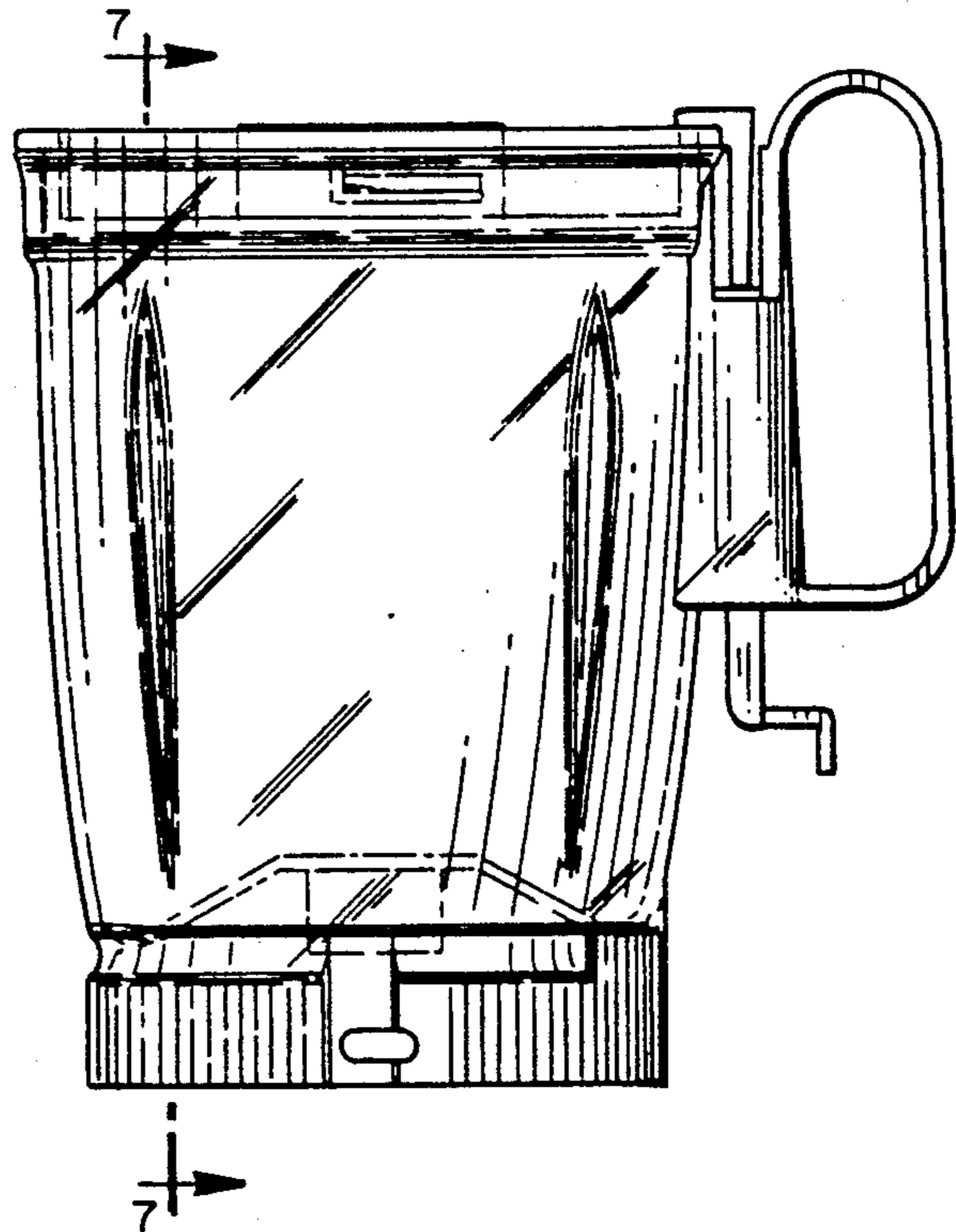
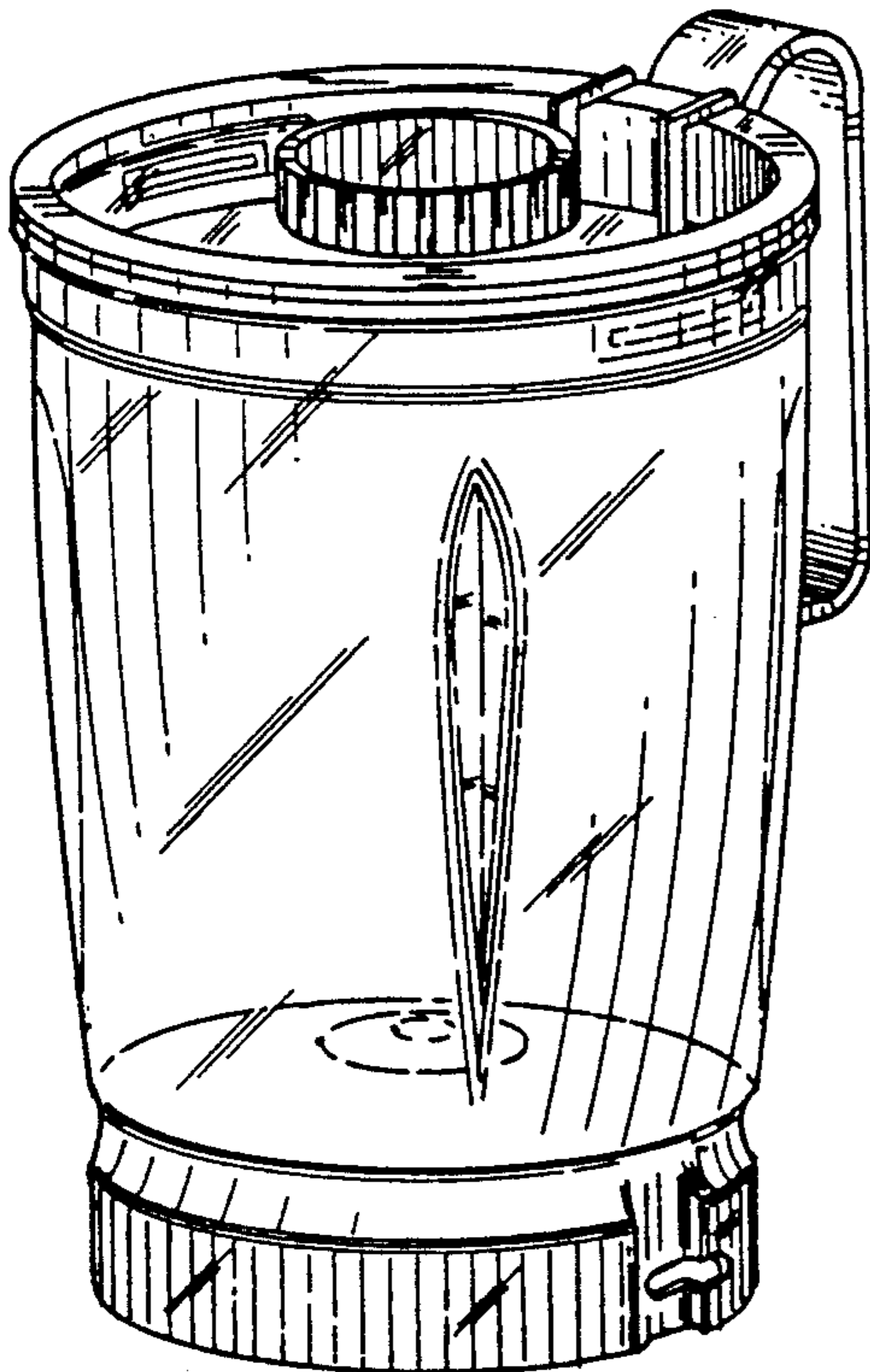

FIG. 1

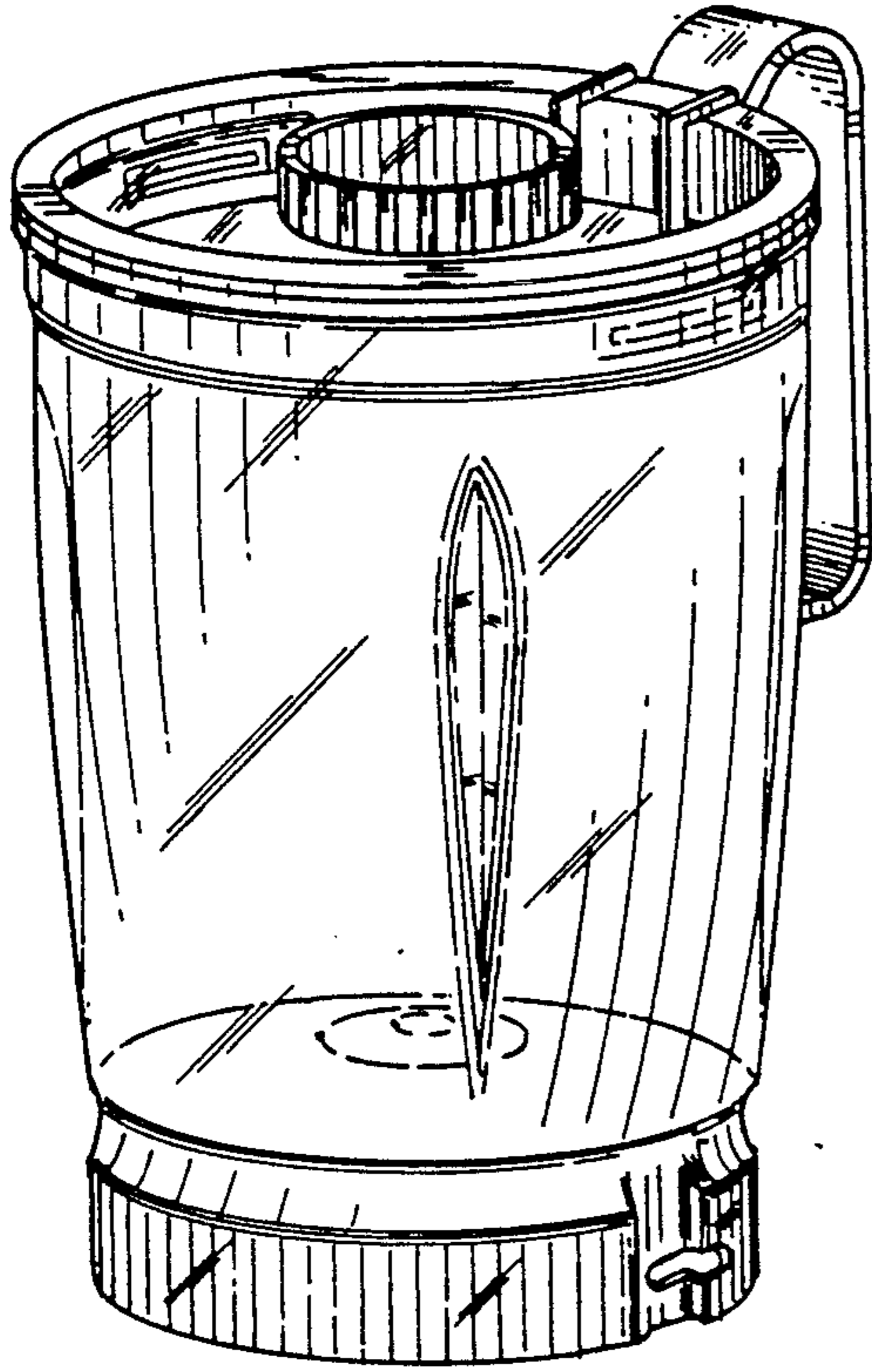

FIG. 2

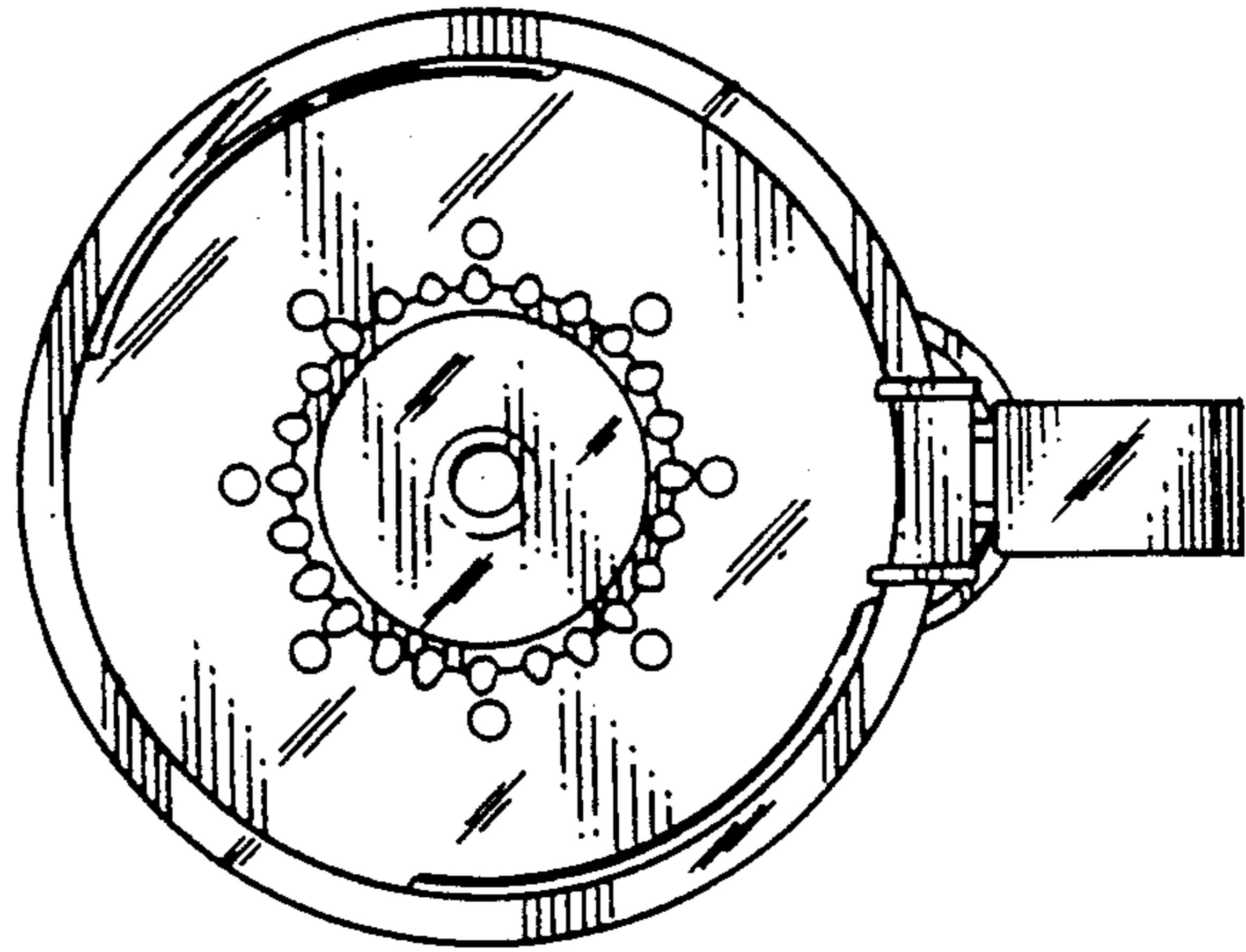

FIG. 3

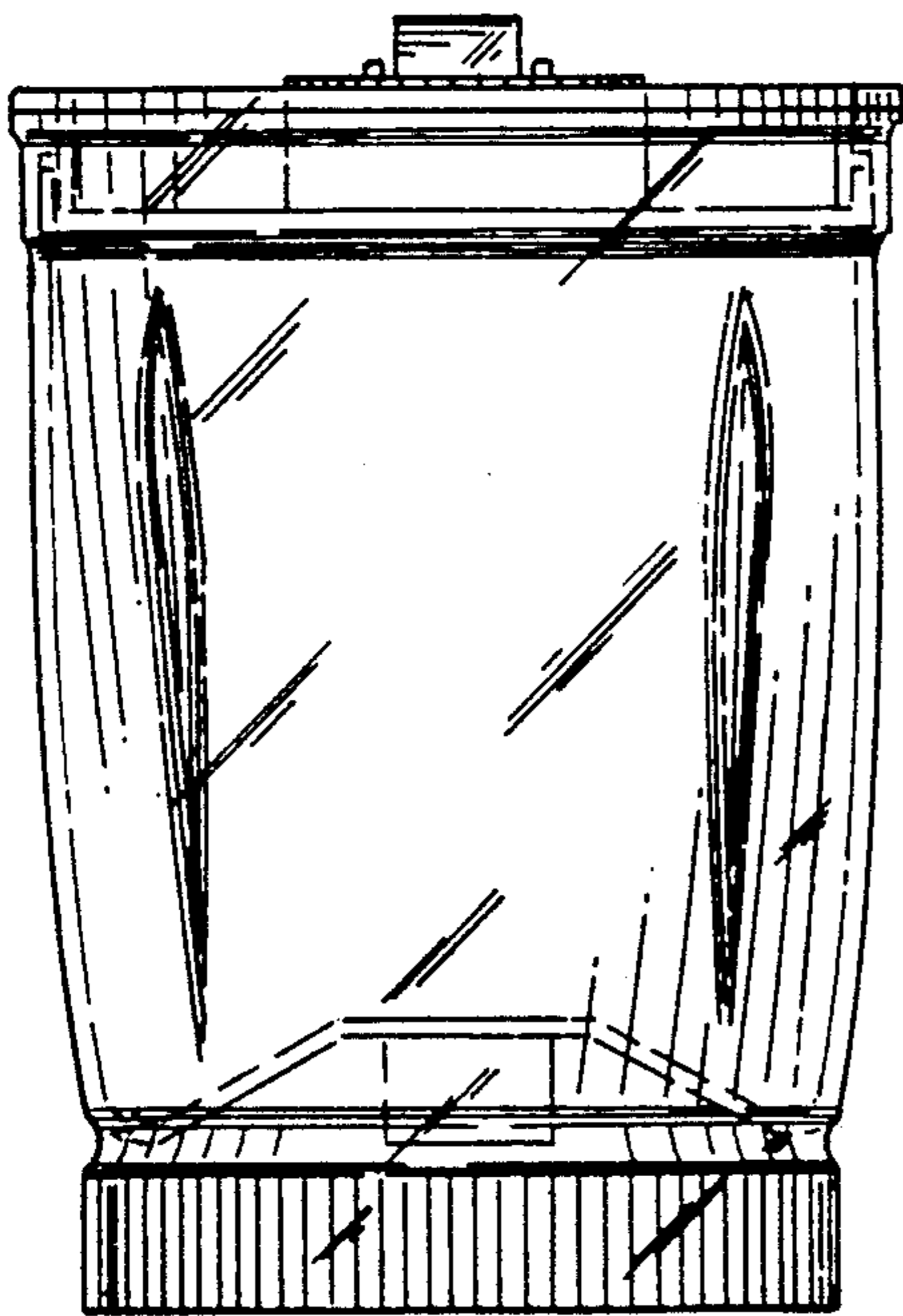

FIG. 4

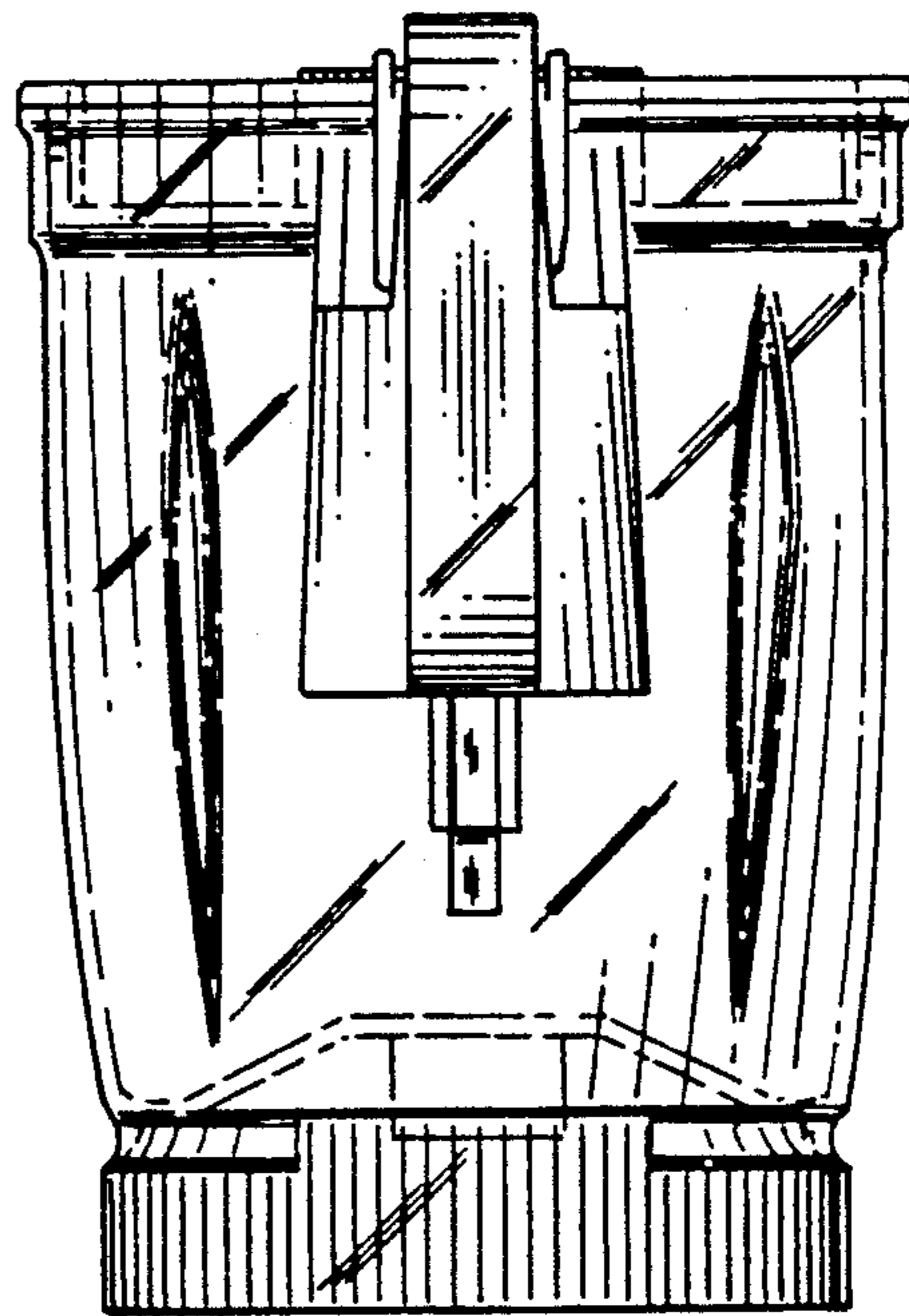

FIG. 5

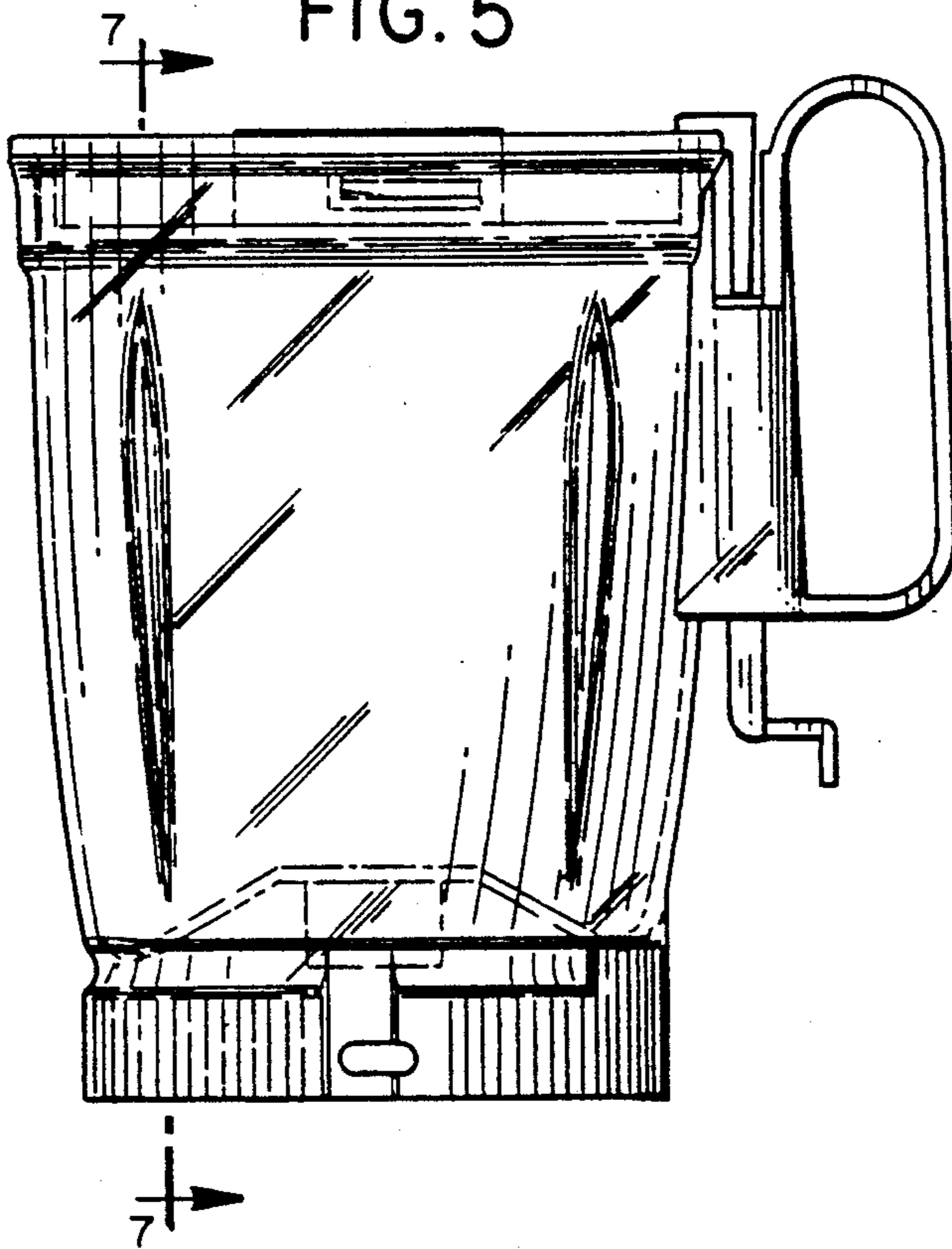

FIG. 7

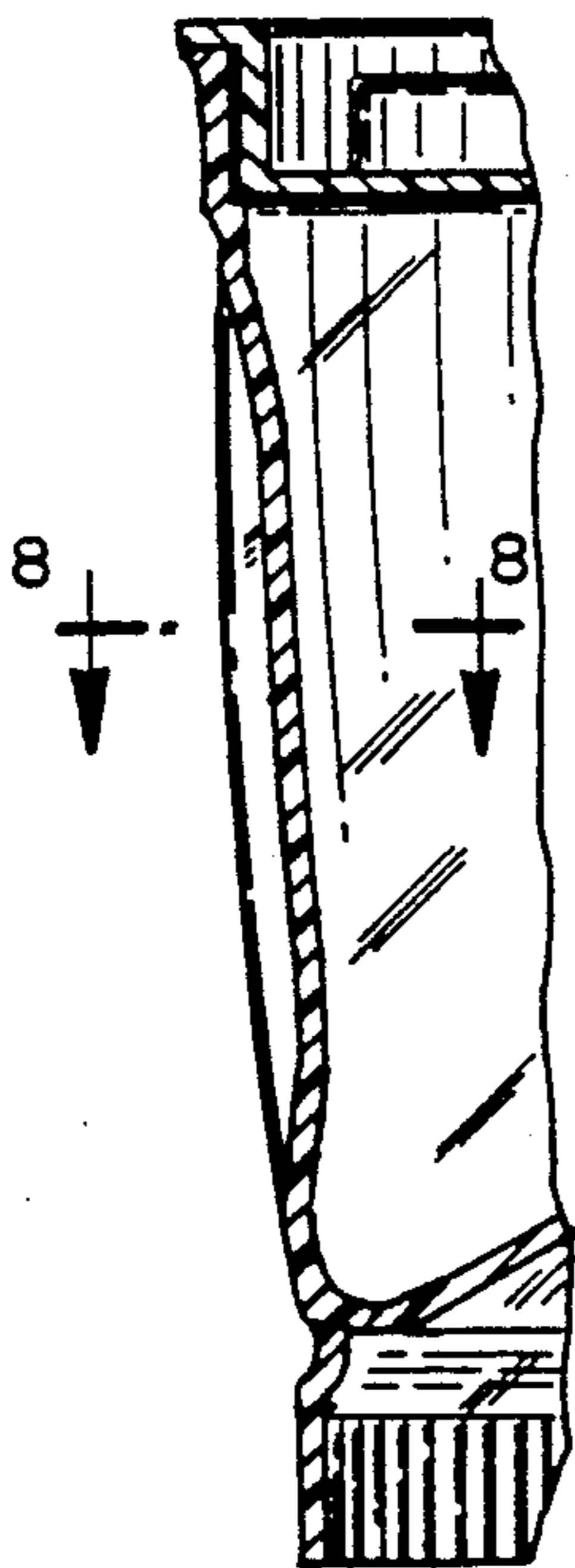

FIG. 8



FIG. 6

