



US00D327801S

United States Patent [19]

Lee

[11] Patent Number: **Des. 327,801**

[45] Date of Patent: **** Jul. 14, 1992**

[54] **COMBINATION SCREWDRIVER, FLASHLIGHT, AND HOLDER ASSEMBLY FOR USE IN EMERGENCIES**

[75] Inventor: **Peter K. C. Lee, Kowloon, Hong Kong**

[73] Assignee: **Hip Shing Fat Company Limited, Kowloon, Hong Kong**

[**] Term: **14 Years**

[21] Appl. No.: **383,147**

[22] Filed: **Jul. 19, 1989**

[30] **Foreign Application Priority Data**

Feb. 7, 1989 [GB] United Kingdom 1056941

[52] U.S. Cl. **D6/553**

[58] Field of Search **D6/553, 569, 572-573; D8/349, 354, 373, 380, 82-87; D26/37-38, 51; D3/30.1; 206/207, 485, 349, 372, 375; 211/13, 60.1, 70.6, 86-87, 89; 248/309.1, 316.1, 316.2, 316.8; 10/109, 121**

[56] **References Cited**

U.S. PATENT DOCUMENTS

D. 244,498	5/1977	Greenlee	D6/571
D. 264,521	5/1982	Parr	D3/30.1
D. 303,774	10/1989	Motazedi	D6/569 X
3,978,984	9/1976	Cowley	211/69 X
4,586,615	5/1986	Quitmann	211/70.6
4,653,637	3/1987	Wallace	211/60.1 X
4,852,930	8/1989	Agee	211/70.6 X

Primary Examiner—Brian N. Vinson
Attorney, Agent, or Firm—Wenderoth, Lind & Ponack

[57] **CLAIM**

The ornamental design for a combination screwdriver, flashlight, and holder assembly for use in emergencies, as shown and described.

DESCRIPTION

FIG. 1 is a front elevational view of a combination screwdriver, flashlight, and holder assembly for use in emergencies showing my new design; FIG. 2 is a top plan view thereof; FIG. 3 is a right side elevational view thereof; FIG. 4 is a left side elevational view thereof; FIG. 5 is a bottom plan view thereof; and, FIG. 6 is a reduced bottom, front, and left side perspective view thereof.

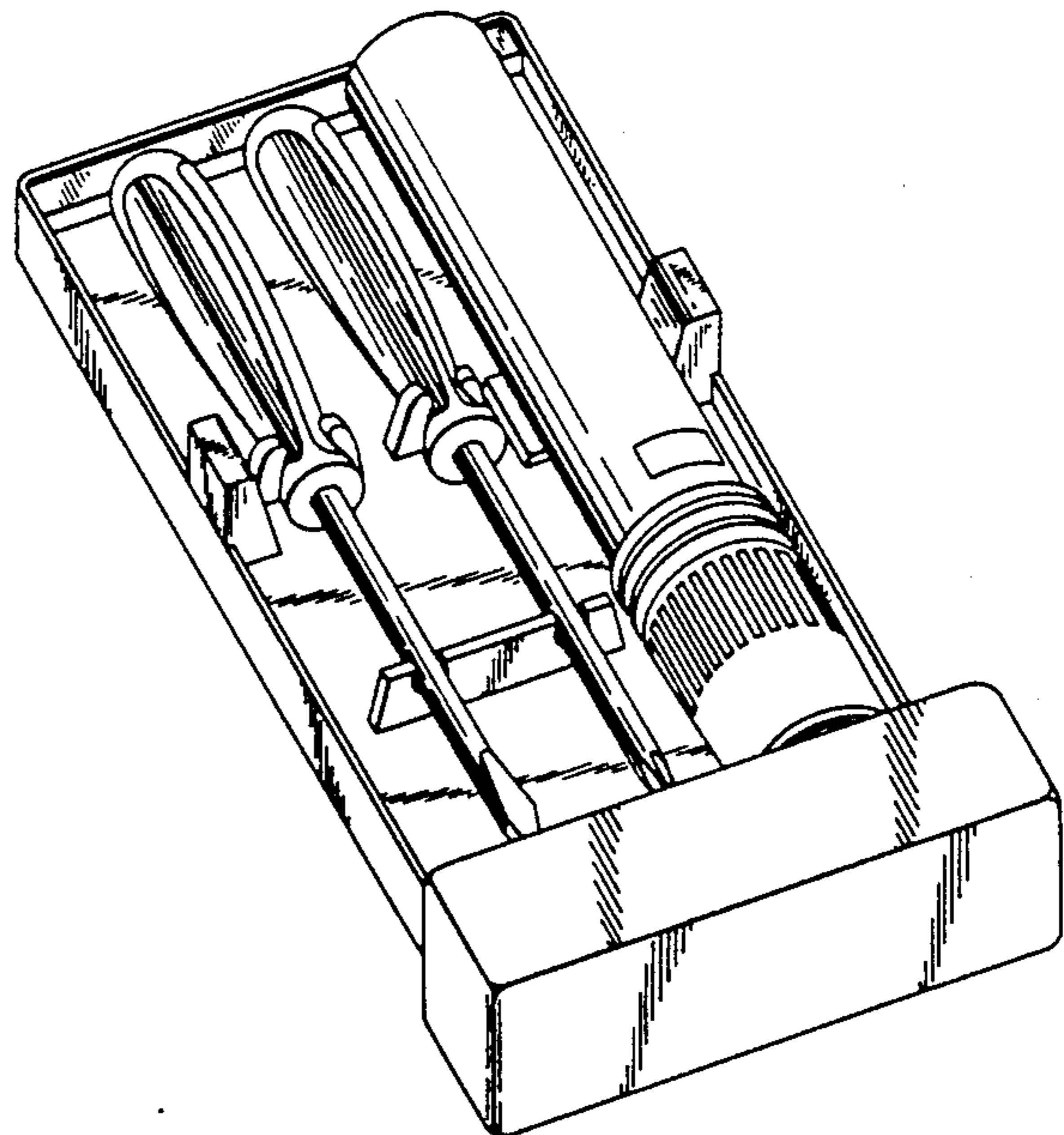
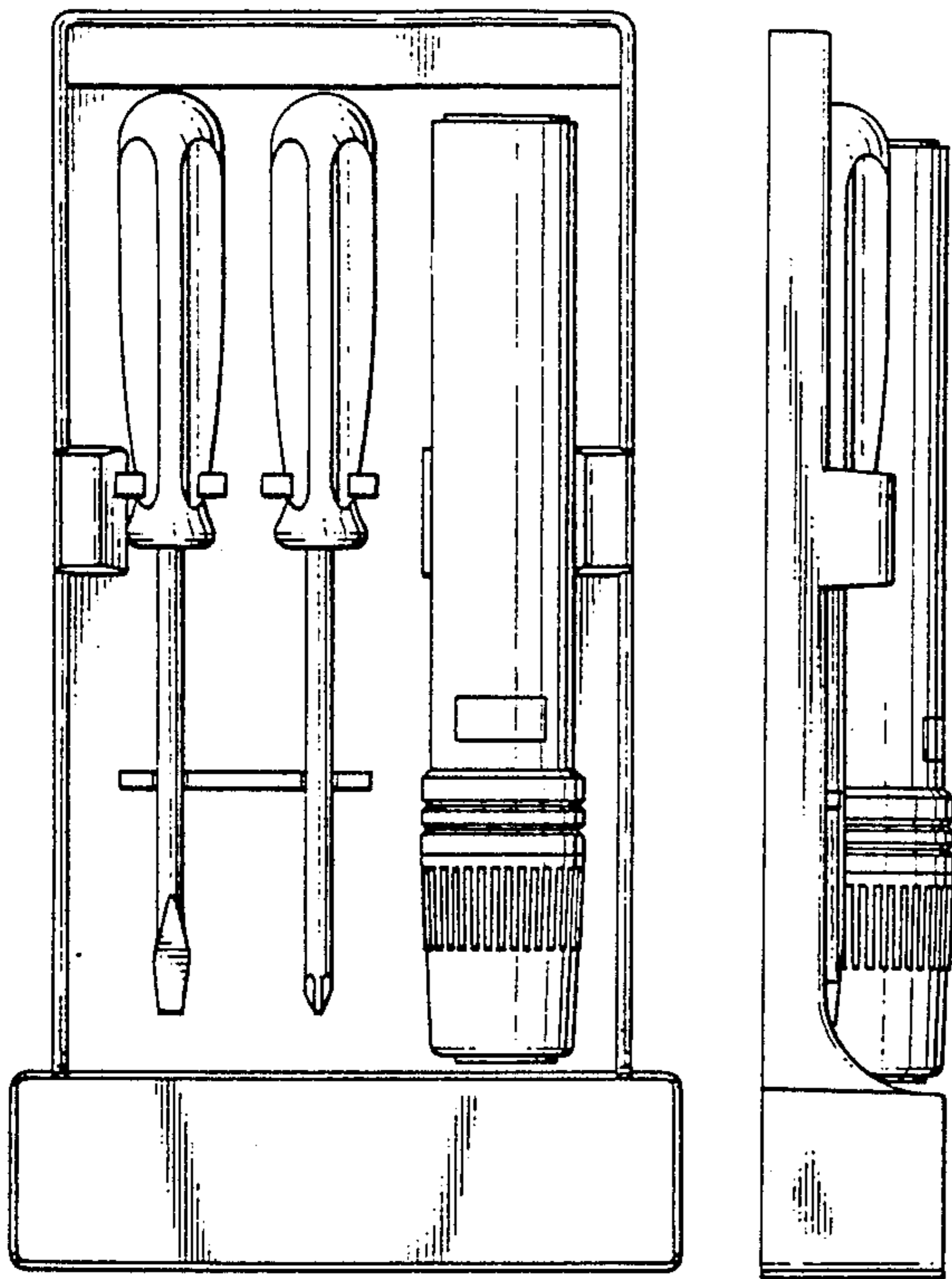

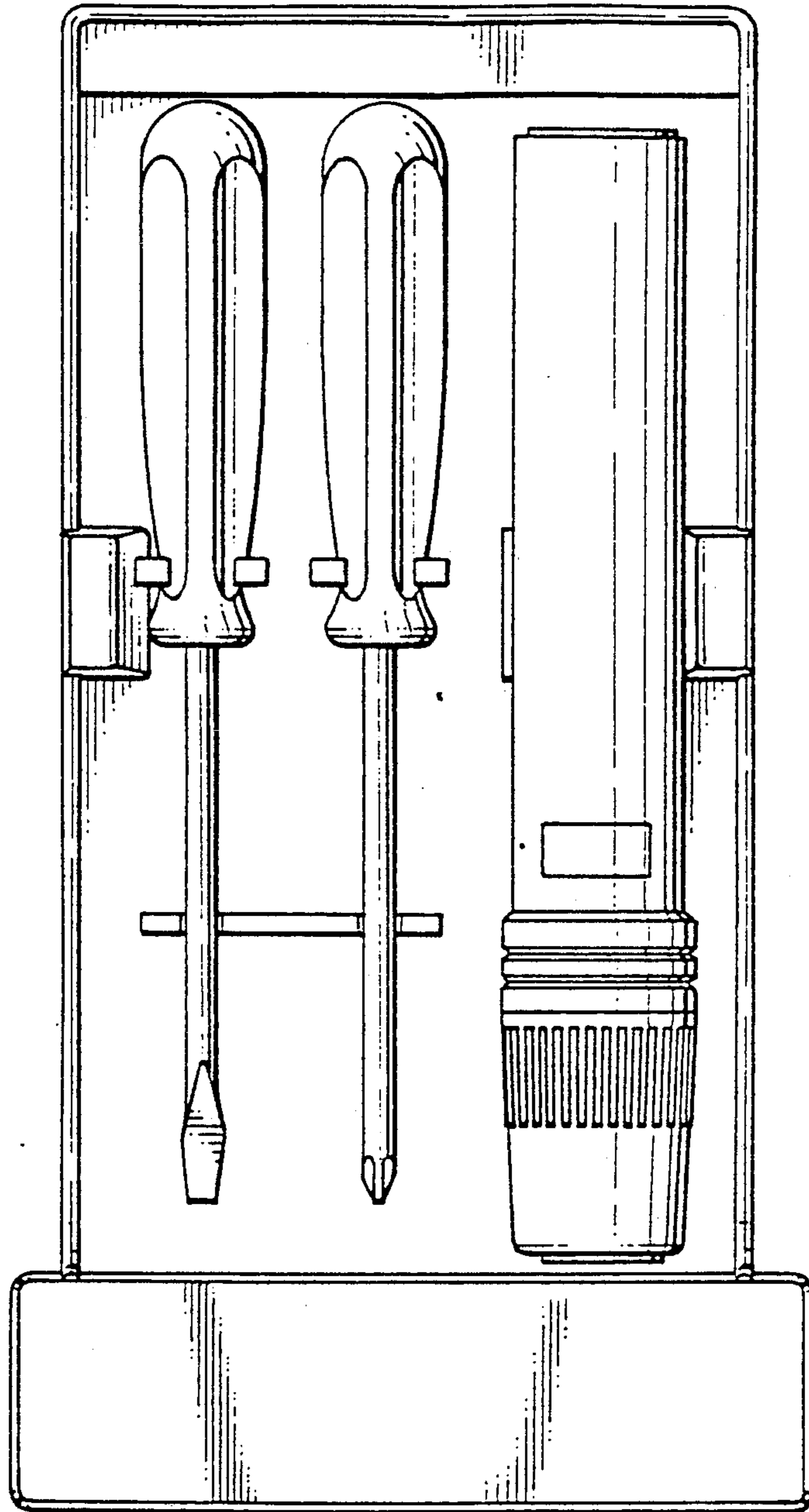

FIG. 1

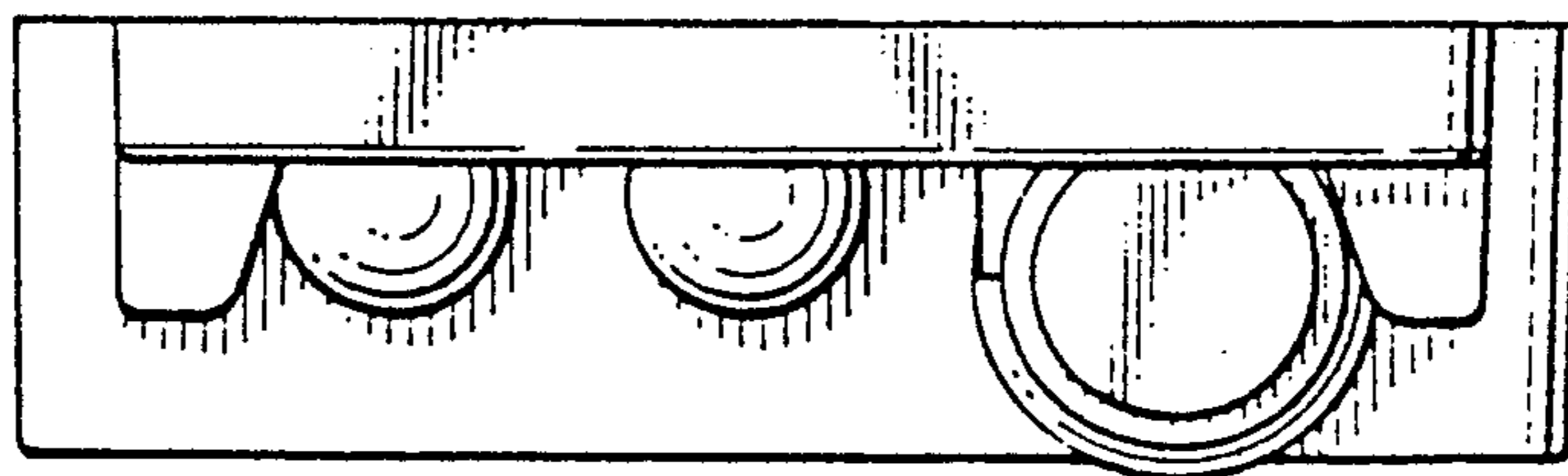

FIG. 2

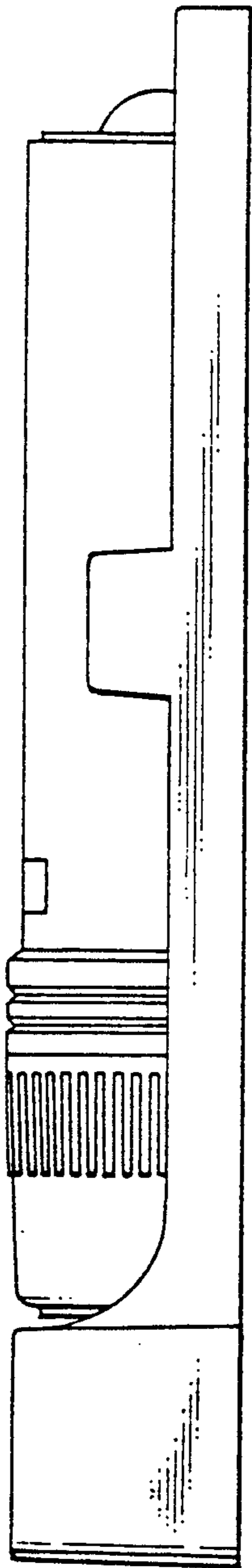

FIG. 3

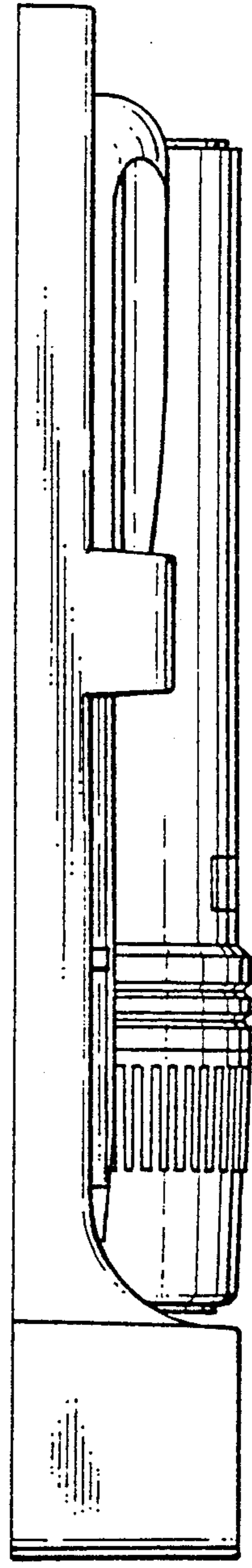

FIG. 4

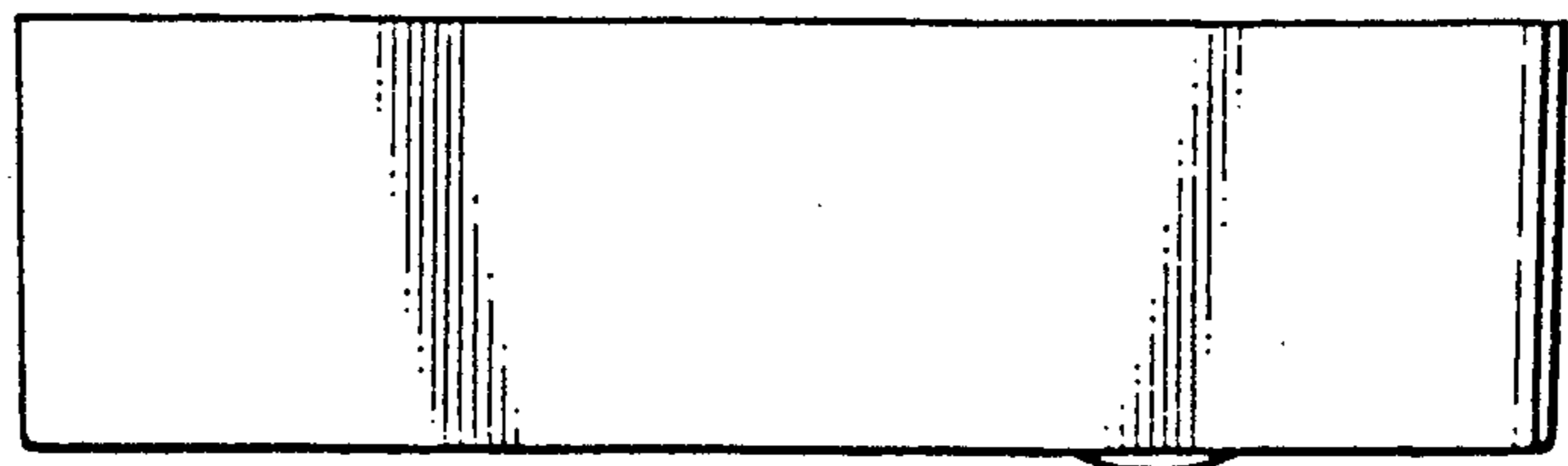

FIG. 5

FIG. 6

