



US00D327758S

# United States Patent [19]

Farrell

[11] Patent Number: **Des. 327,758**

[45] Date of Patent: **\*\* Jul. 7, 1992**

[54] TRASH CONTAINER CART

4,017,092 4/1977 Boomer ..... 248/98

[76] Inventor: **Thomas P. Farrell**, 97 Cedar Hill Rd., Northboro, Mass. 01532

*Primary Examiner*—Kay H. Chin  
*Attorney, Agent, or Firm*—Leon Gilden

[\*\*] Term: **14 Years**

[57] **CLAIM**

[21] Appl. No.: **538,481**

The ornamental design for a trash container cart, as shown and described.

[22] Filed: **Jun. 15, 1990**

[52] U.S. Cl. .... **D34/5; D34/25**

[58] Field of Search ..... **D34/1, 5, 12, 24, 25, D34/26; 248/95, 97, 98, 99, 100, 101; 280/47.19, 47.26; 220/908, 909**

### DESCRIPTION

FIG. 1 is a front elevational view of a trash container cart with the lid in open condition showing my new design;

FIG. 2 is a rear elevational view thereof;

FIG. 3 is a left side elevational view thereof;

FIG. 4 is a right side elevational view thereof;

FIG. 5 is a top plan view thereof;

FIG. 6 is a bottom plan view thereof; and,

FIG. 7 is a top front perspective view thereof.

### [56] References Cited

#### U.S. PATENT DOCUMENTS

D. 297,378	8/1988	Briscoe	.....	D34/5
D. 303,306	9/1989	Briscoe	.....	D34/5
3,191,960	6/1965	Turner	.....	280/47.19

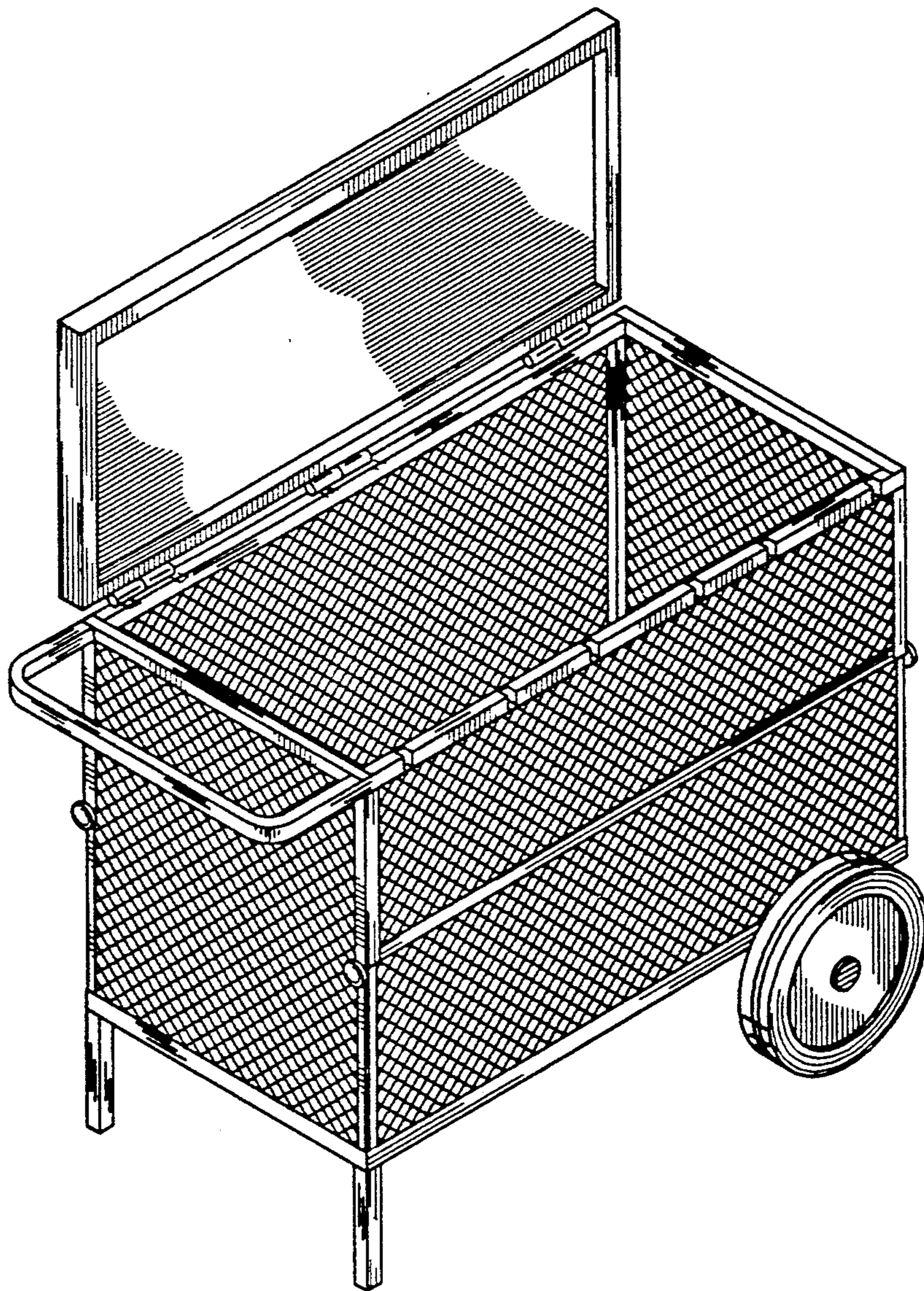

FIG. 1

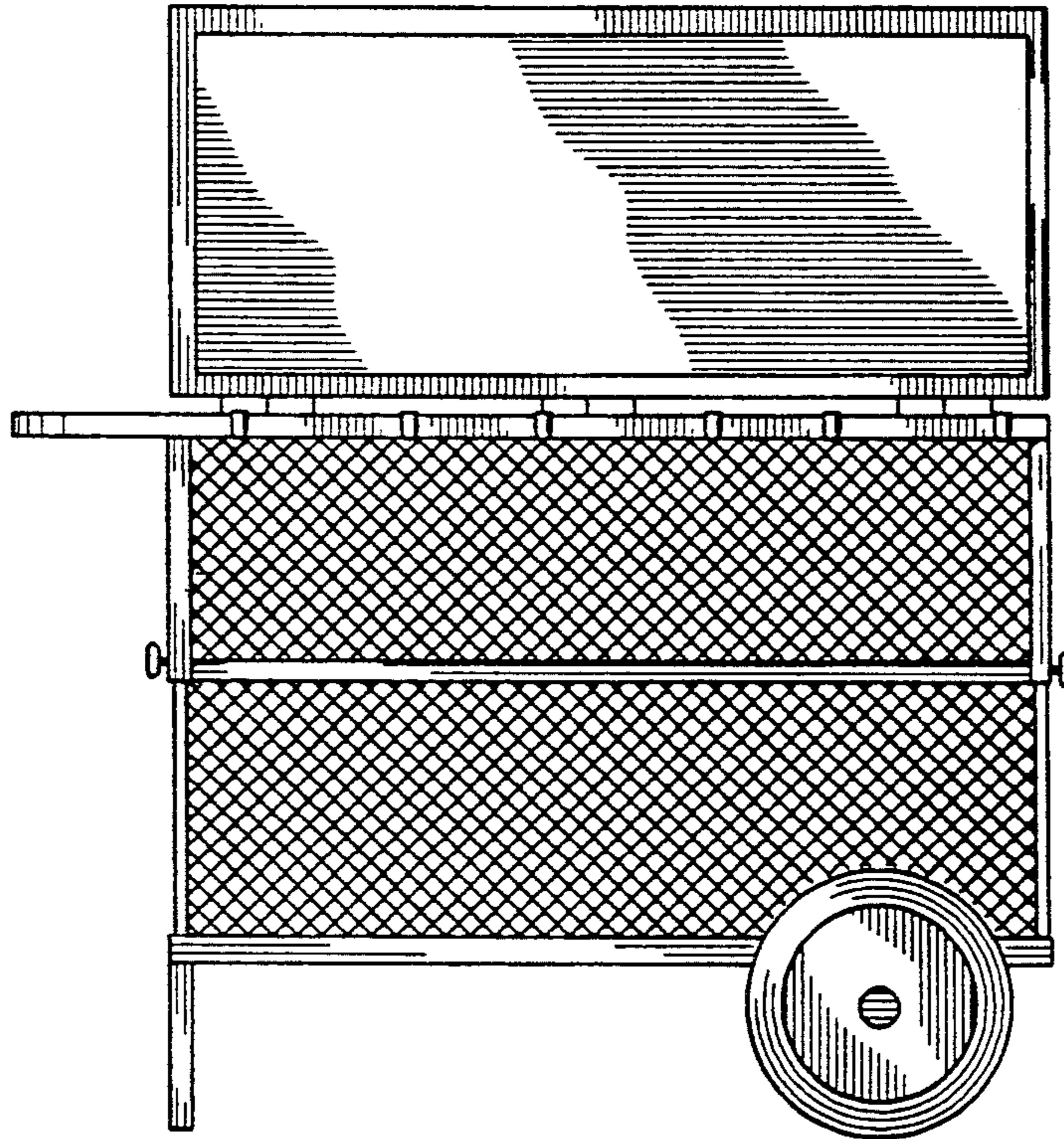

FIG. 2

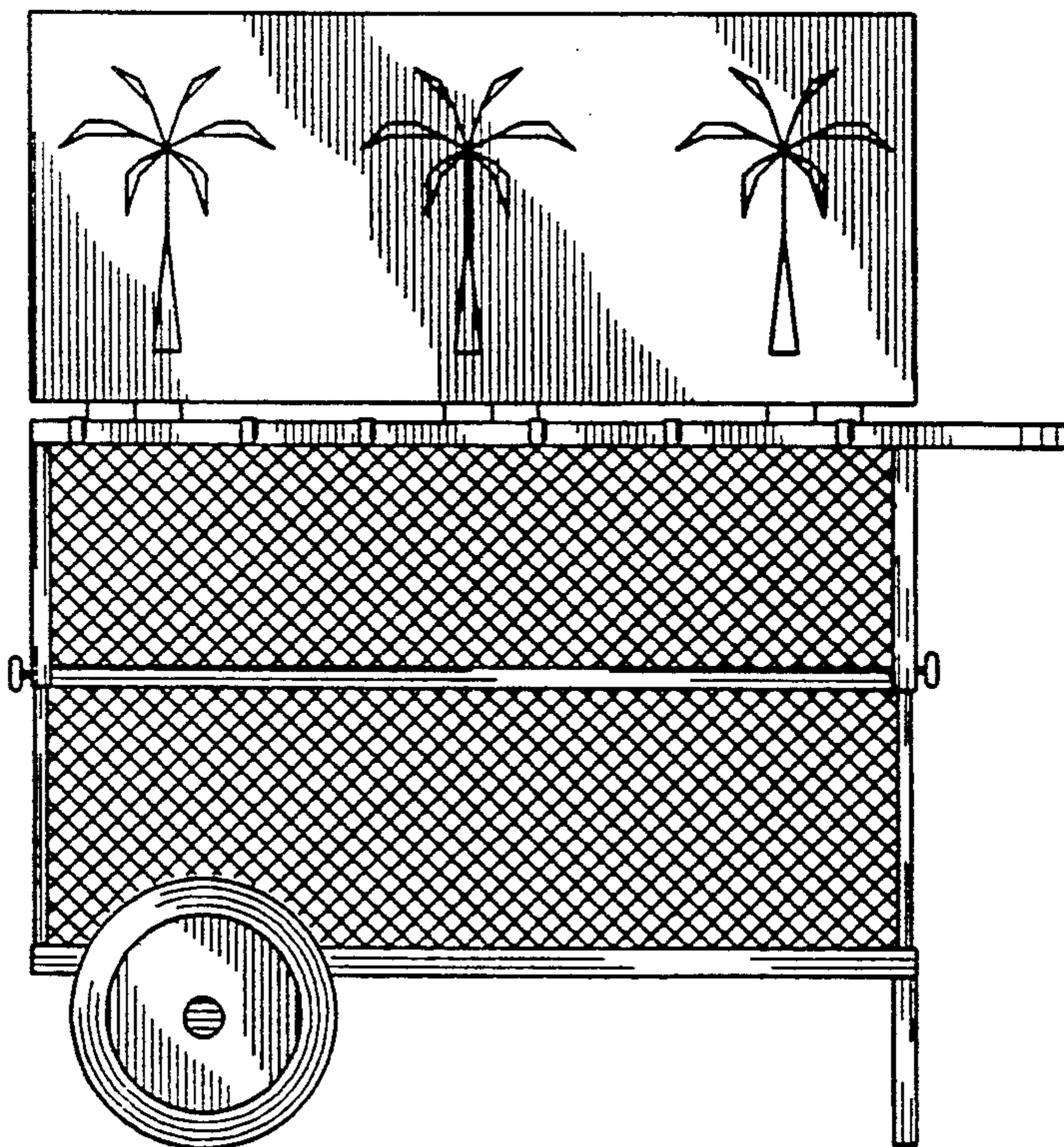

FIG. 3

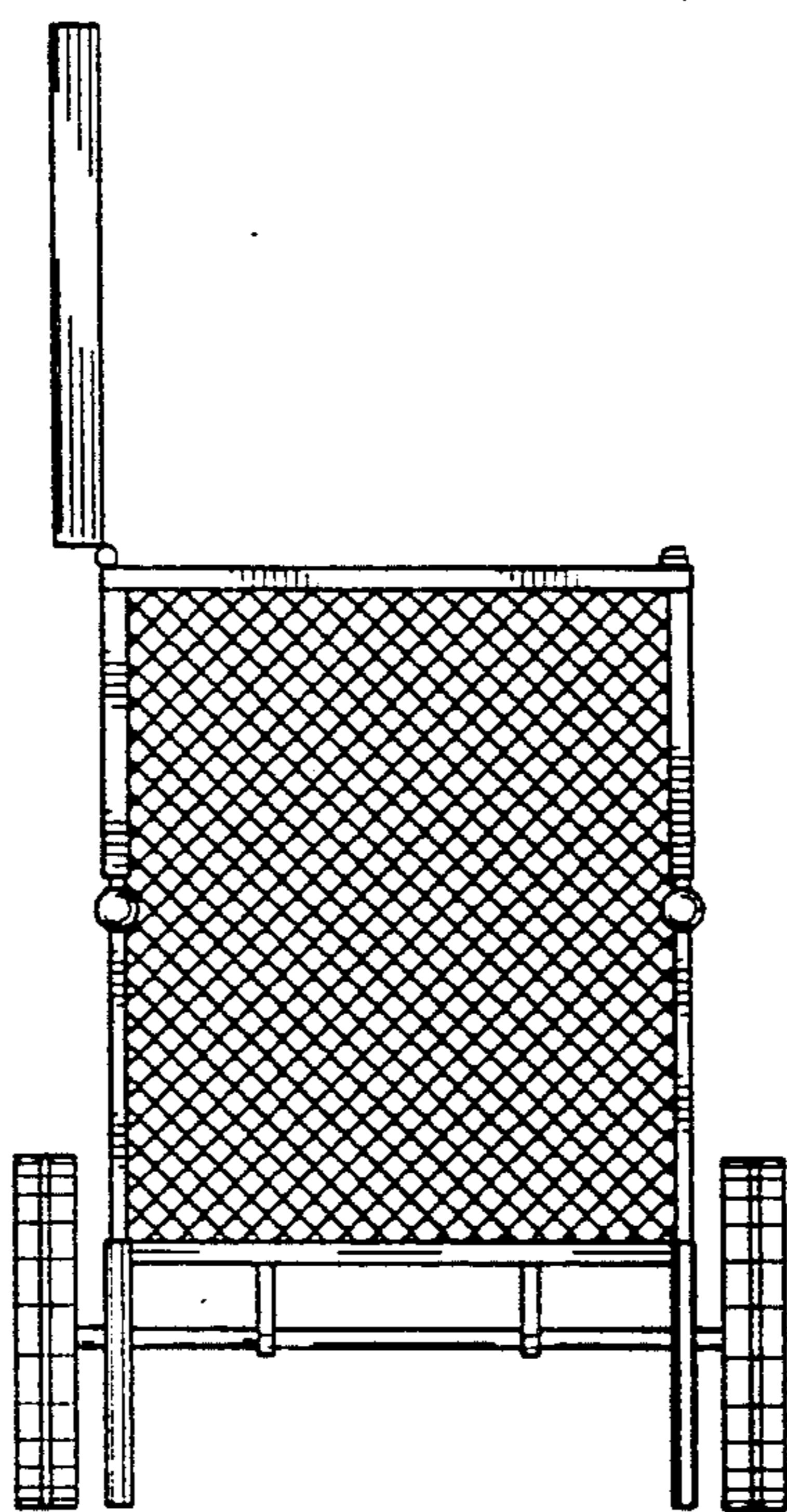
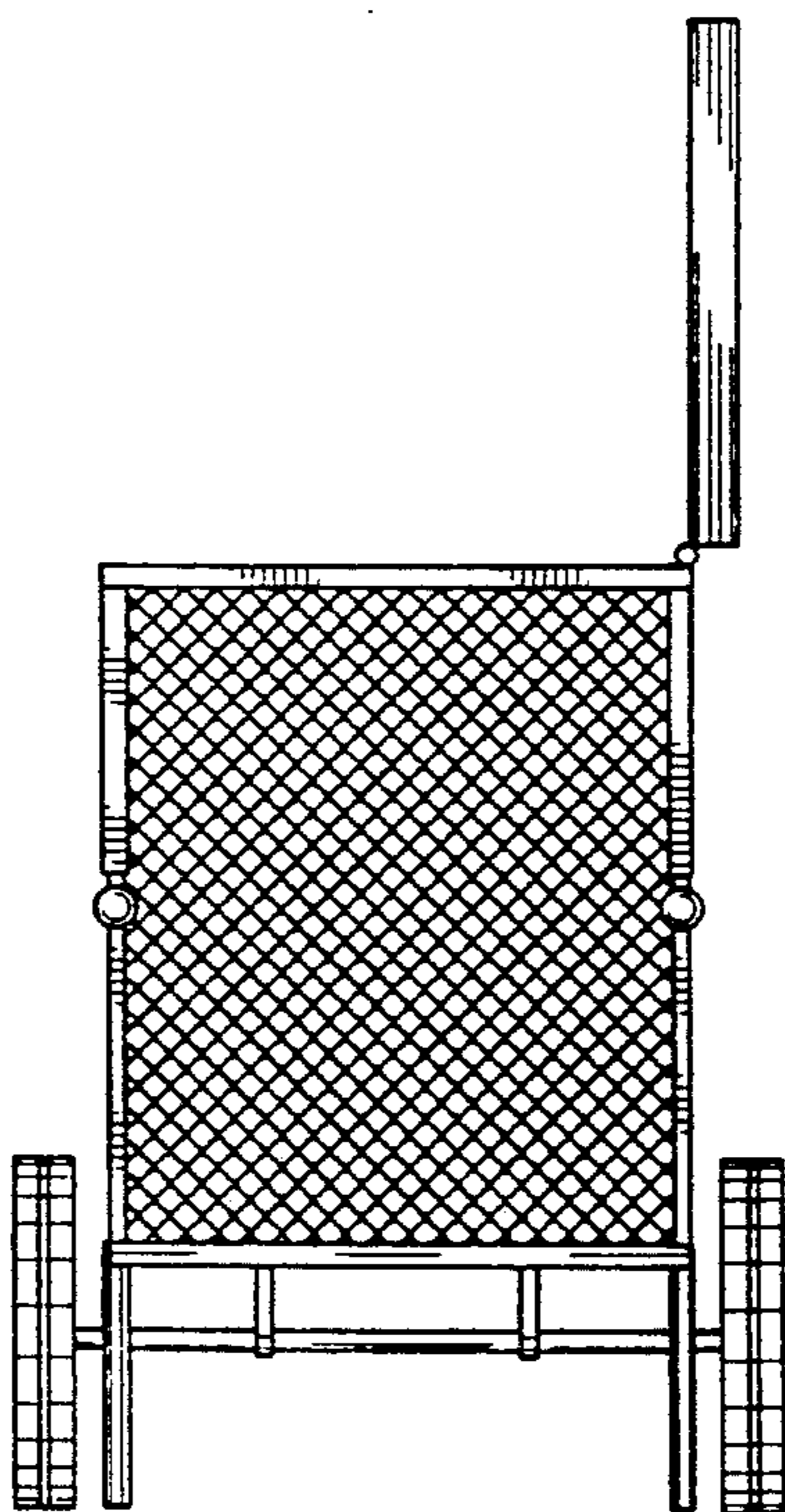
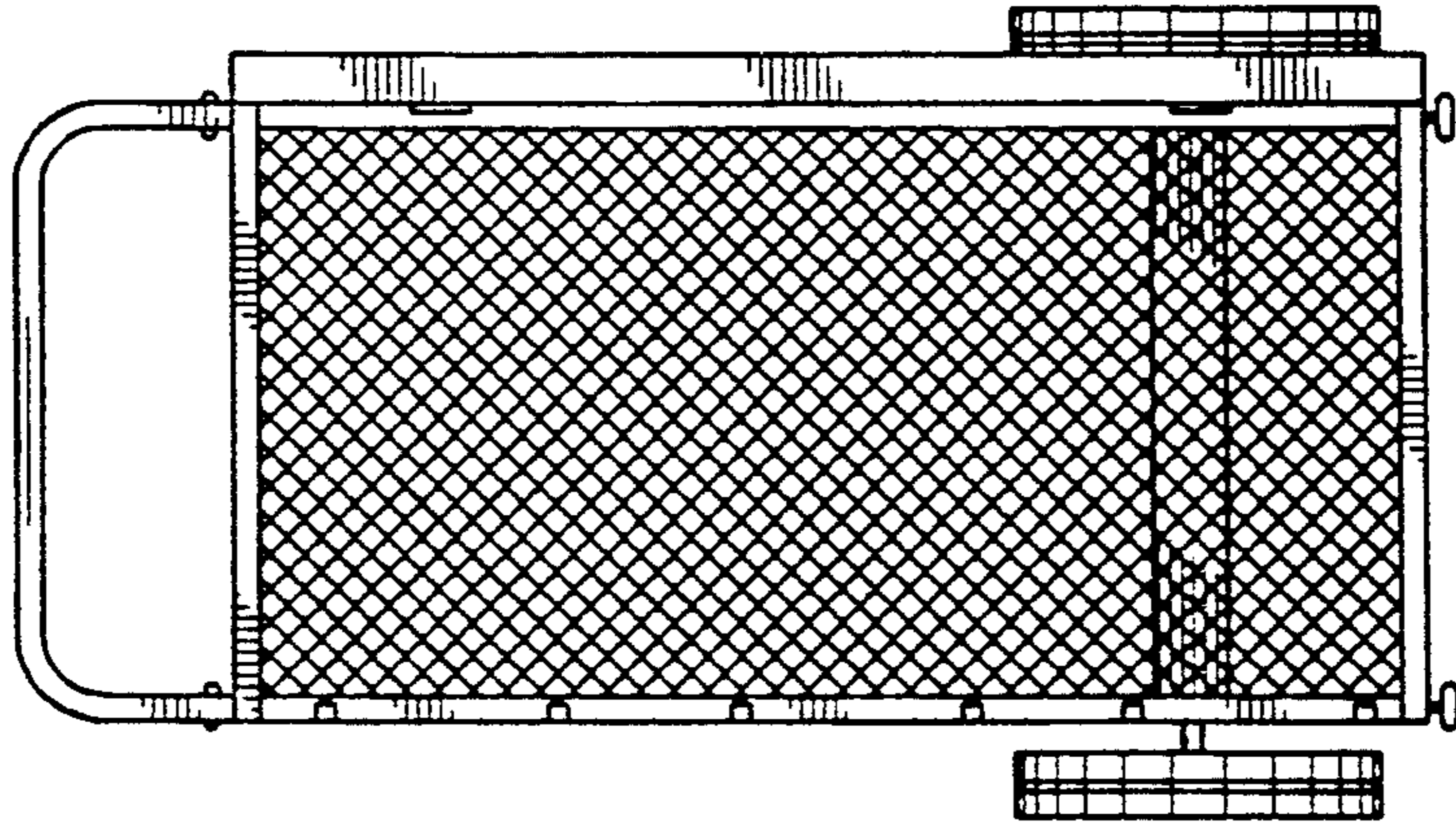

FIG. 4



*FIG. 5*



*FIG. 6*

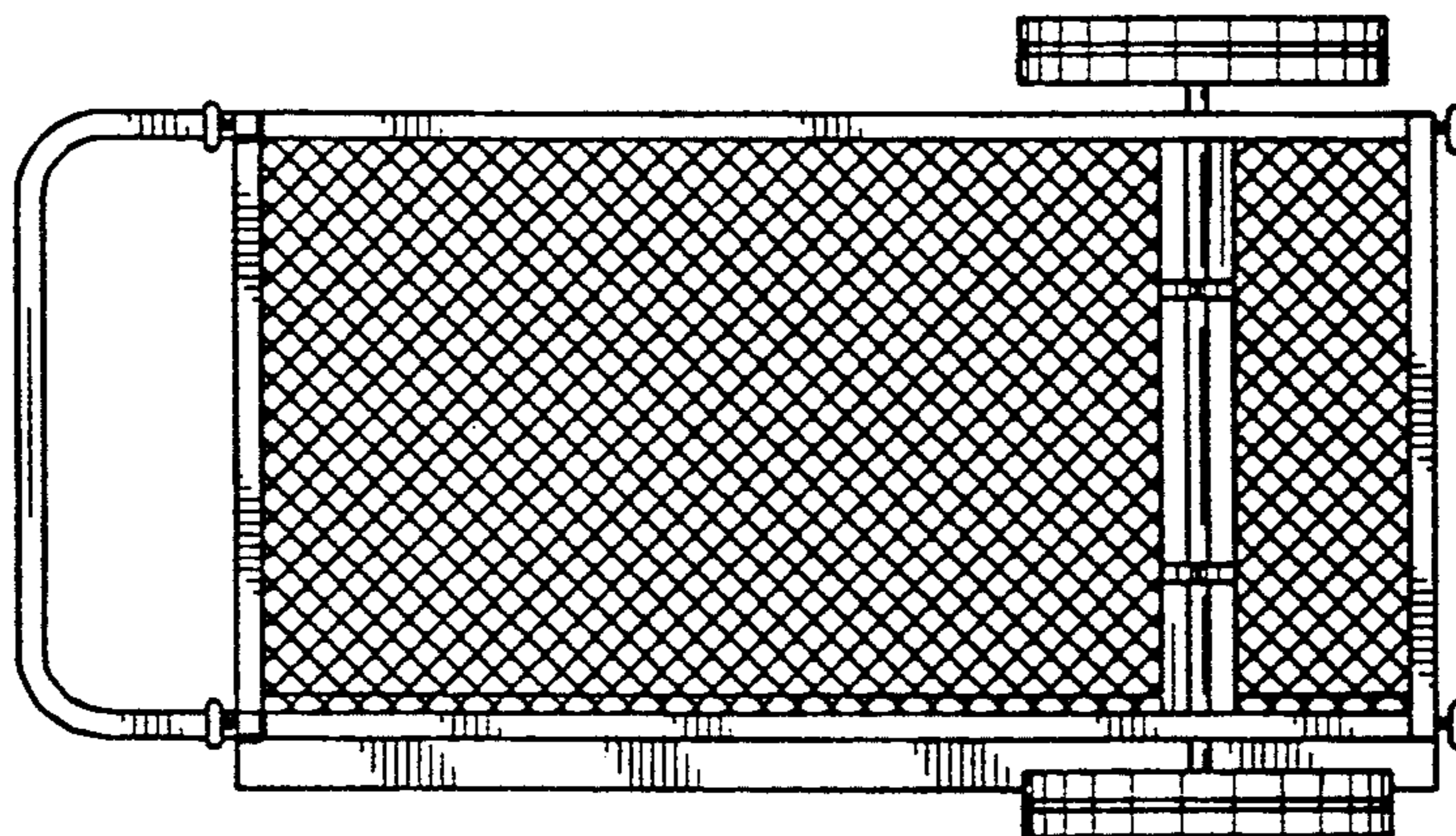

FIG. 7

