



US00D327755S

United States Patent [19]

[11] Patent Number: **Des. 327,755**

Boyer

[45] Date of Patent: **** Jul. 7, 1992**

[54] **COMBINED PAINT ROLLER TRAY AND COVER THEREFOR**

3,909,092	9/1975	Kiernan	220/555
4,445,250	5/1984	Seidl	15/257.06
4,547,926	10/1985	Kern	15/257.06
4,651,379	3/1987	Kern	15/257.06

[76] Inventor: **Jerry D. Boyer**, P.O. Box 121, Andrews, Tex. 79714

Primary Examiner—Wallace R. Burke
Assistant Examiner—Lavone D. Tabor
Attorney, Agent, or Firm—Terry M. Gernstein

[**] Term: **14 Years**

[21] Appl. No.: **436,228**

[57] **CLAIM**

[22] Filed: **Nov. 14, 1989**

[52] U.S. Cl. **D32/53.1**

The ornamental design for a combined paint brush roller tray and cover therefor, as shown and described.

[58] Field of Search **D32/53, 53.1, 54; D9/424-425; 15/257.05, 257.06; 206/518, 557; 220/555, 570-571; D6/453**

DESCRIPTION

[56] **References Cited**

U.S. PATENT DOCUMENTS

D. 100,240	6/1936	Wright	D6/453
D. 227,305	6/1973	Wilke	D9/425
D. 289,456	4/1987	Florentino	D32/53.1
D. 293,144	12/1987	Papke	D32/53.1
D. 307,867	5/1990	Lewis	D9/424

FIG. 1 is a perspective view of a combined paint roller tray and cover therefor showing my new design; FIG. 2 is a front end elevational view thereof; FIG. 3 is a rear end elevational view thereof; FIG. 4 is a side elevational view thereof; FIG. 5 is a side elevational view thereof; FIG. 6 is a top plan view thereof; and FIG. 7 is a bottom plan view thereof.

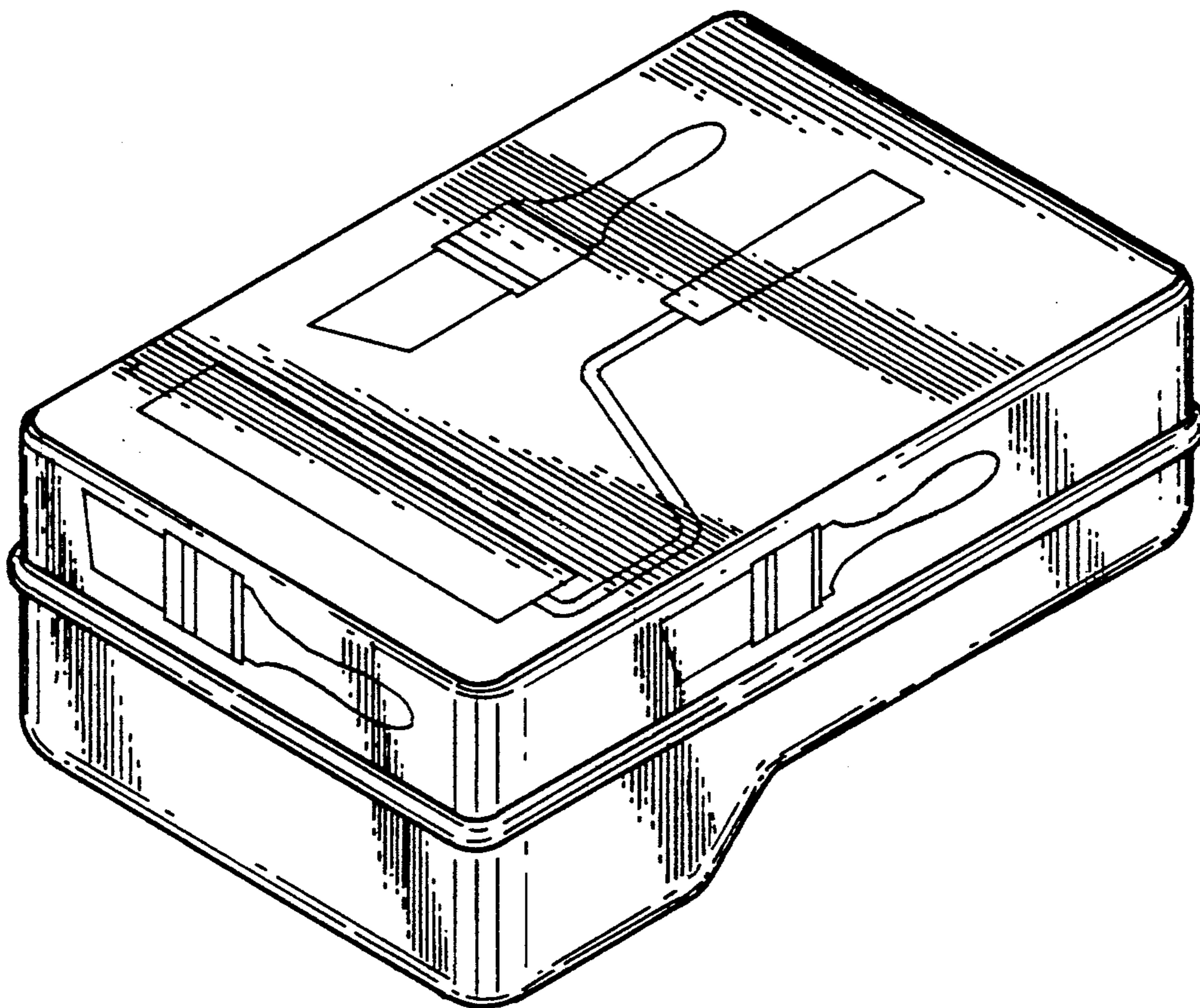

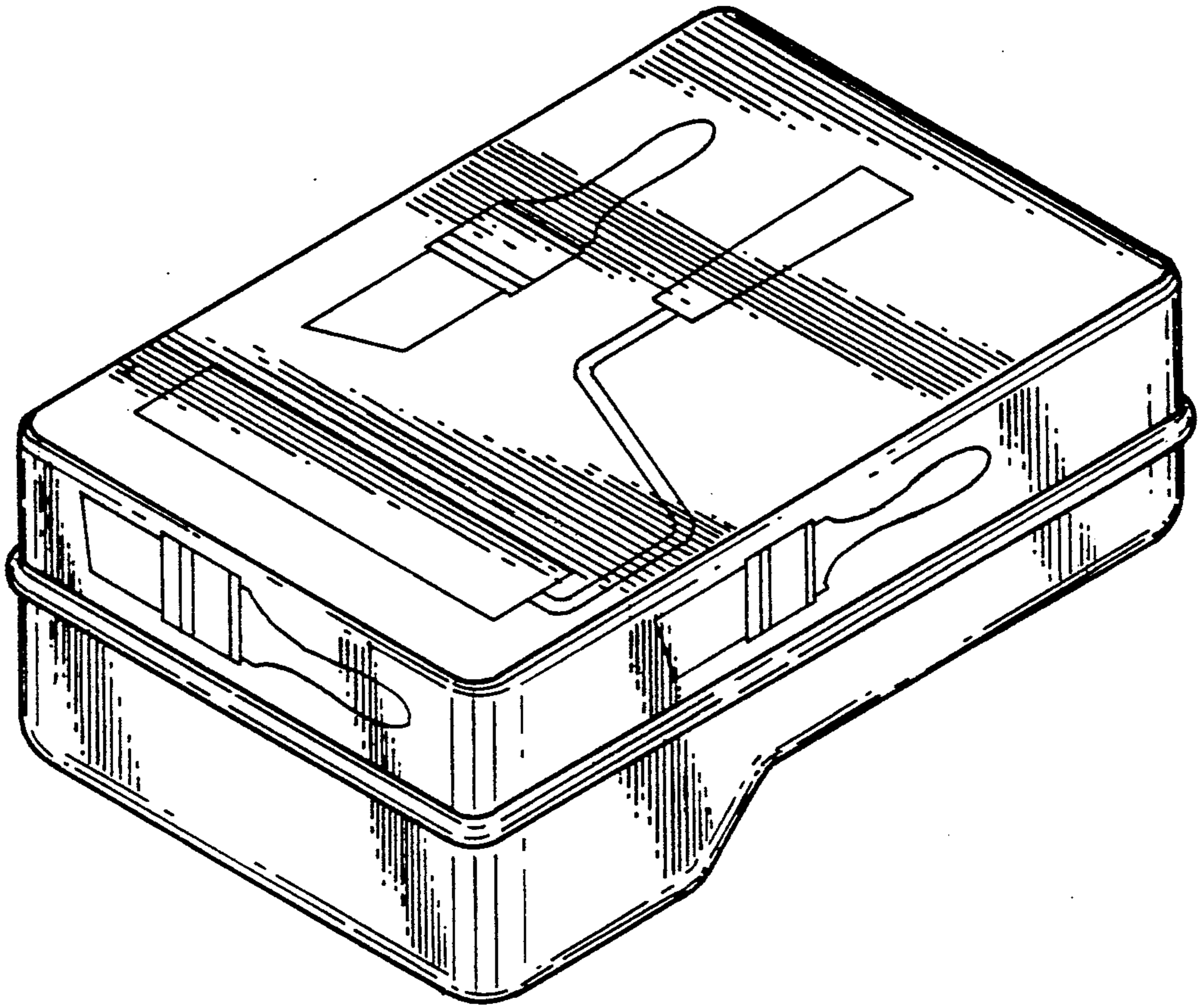
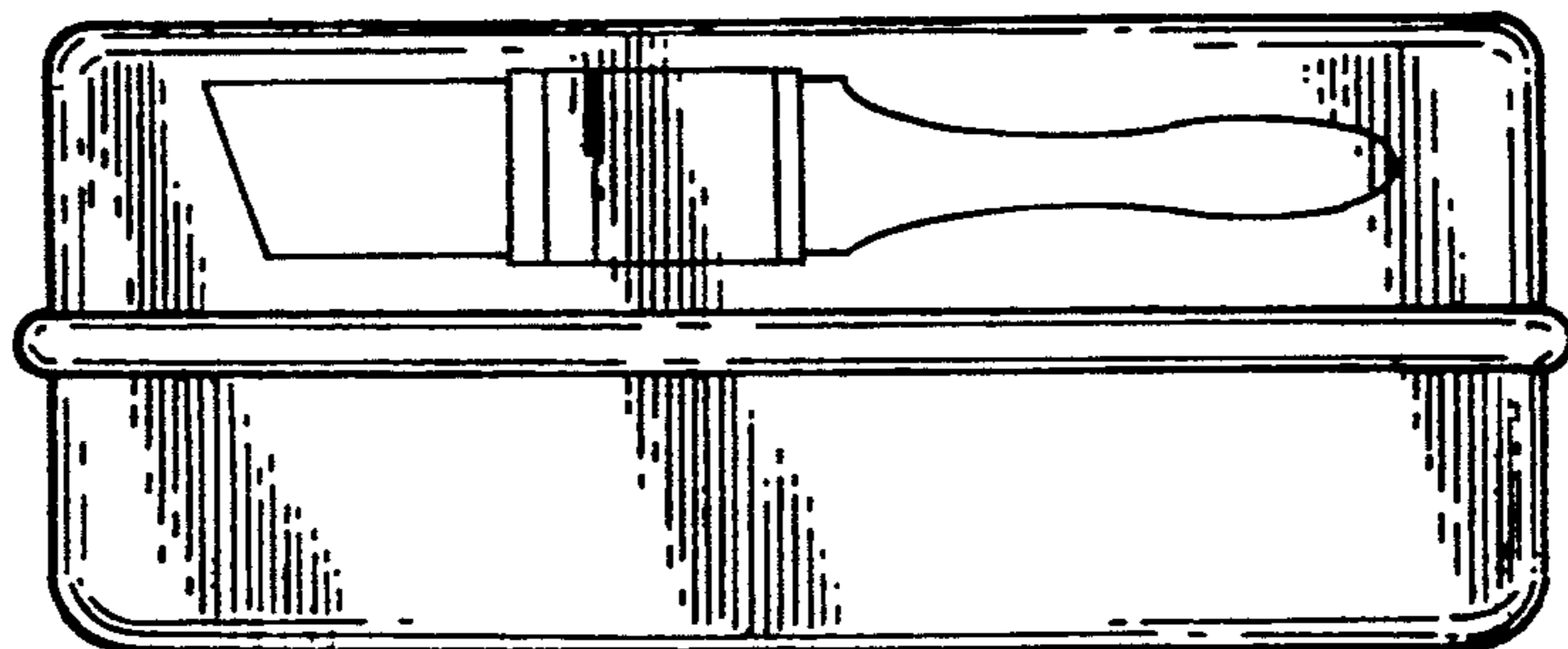

FIG. 1

FIG. 2



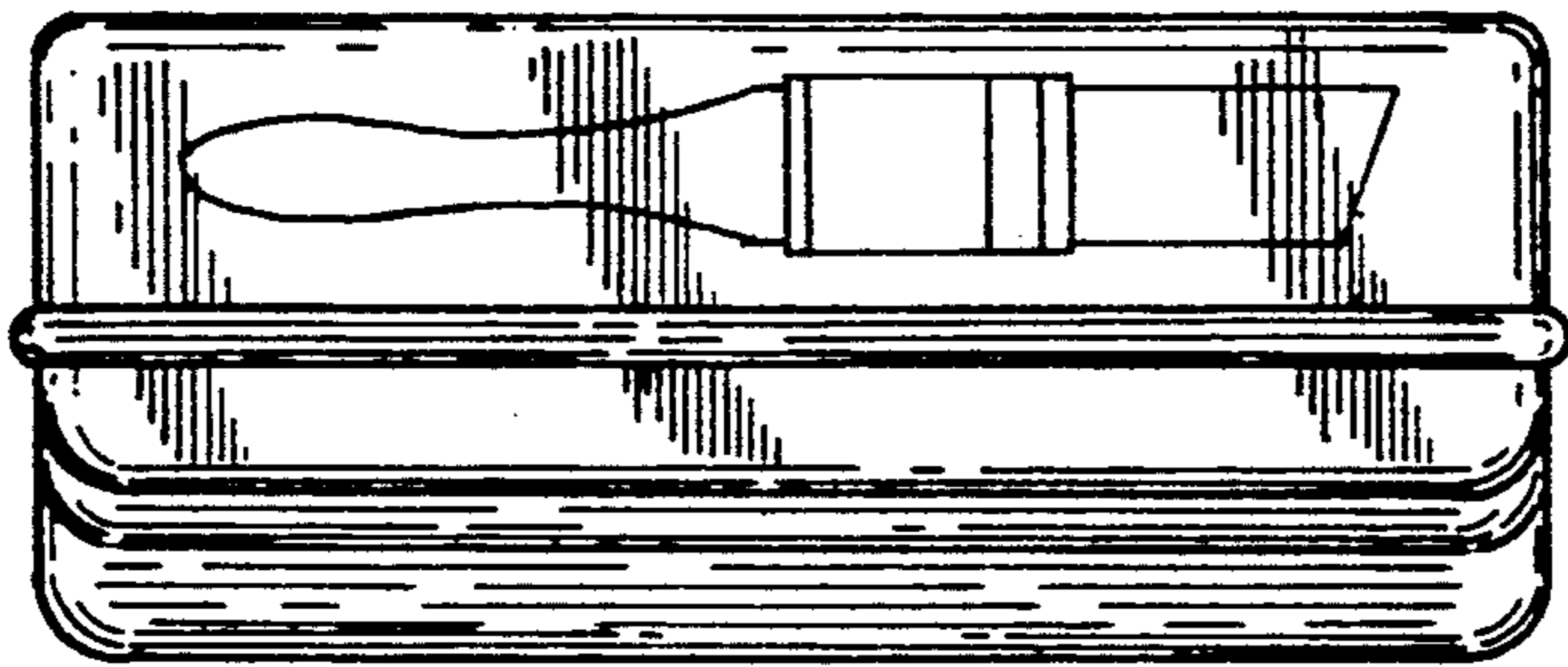

FIG. 3

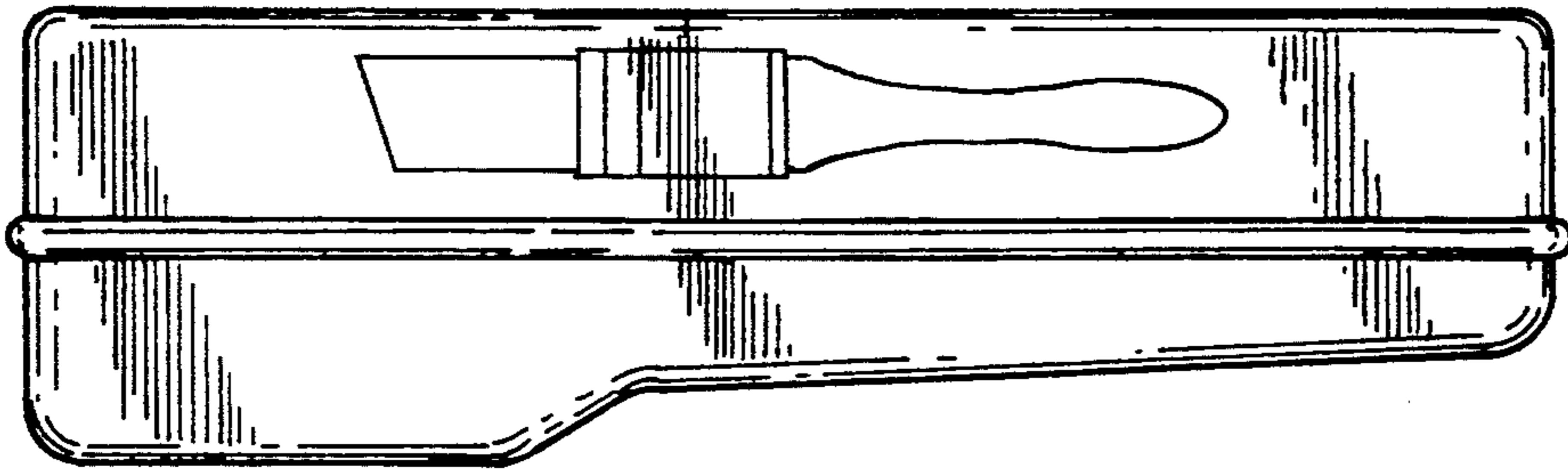

FIG. 4

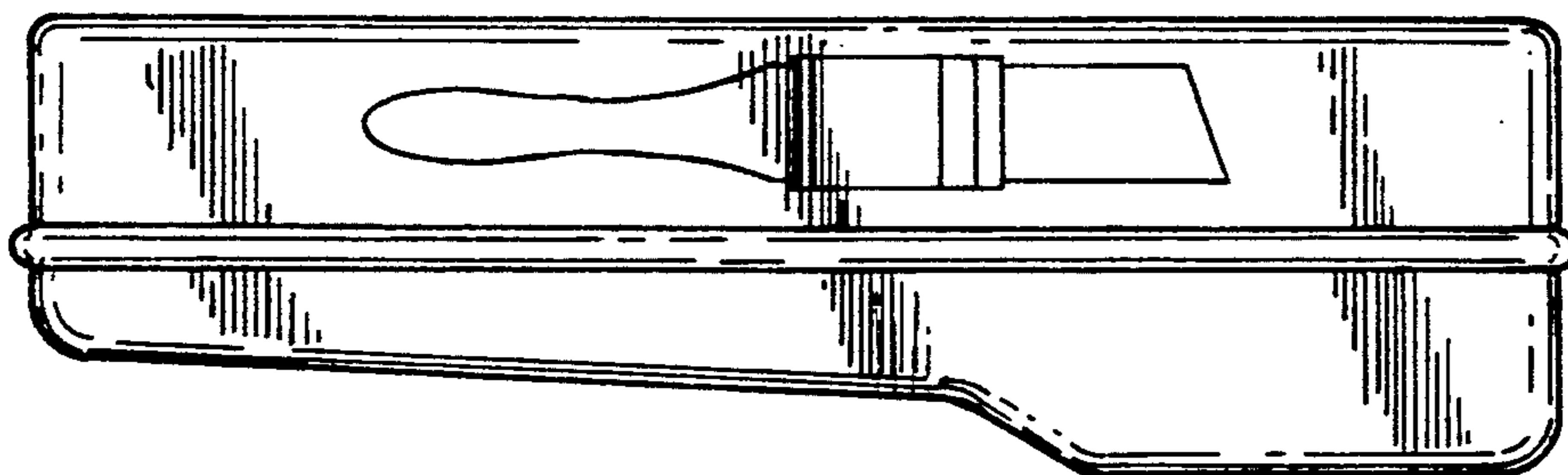

FIG. 5

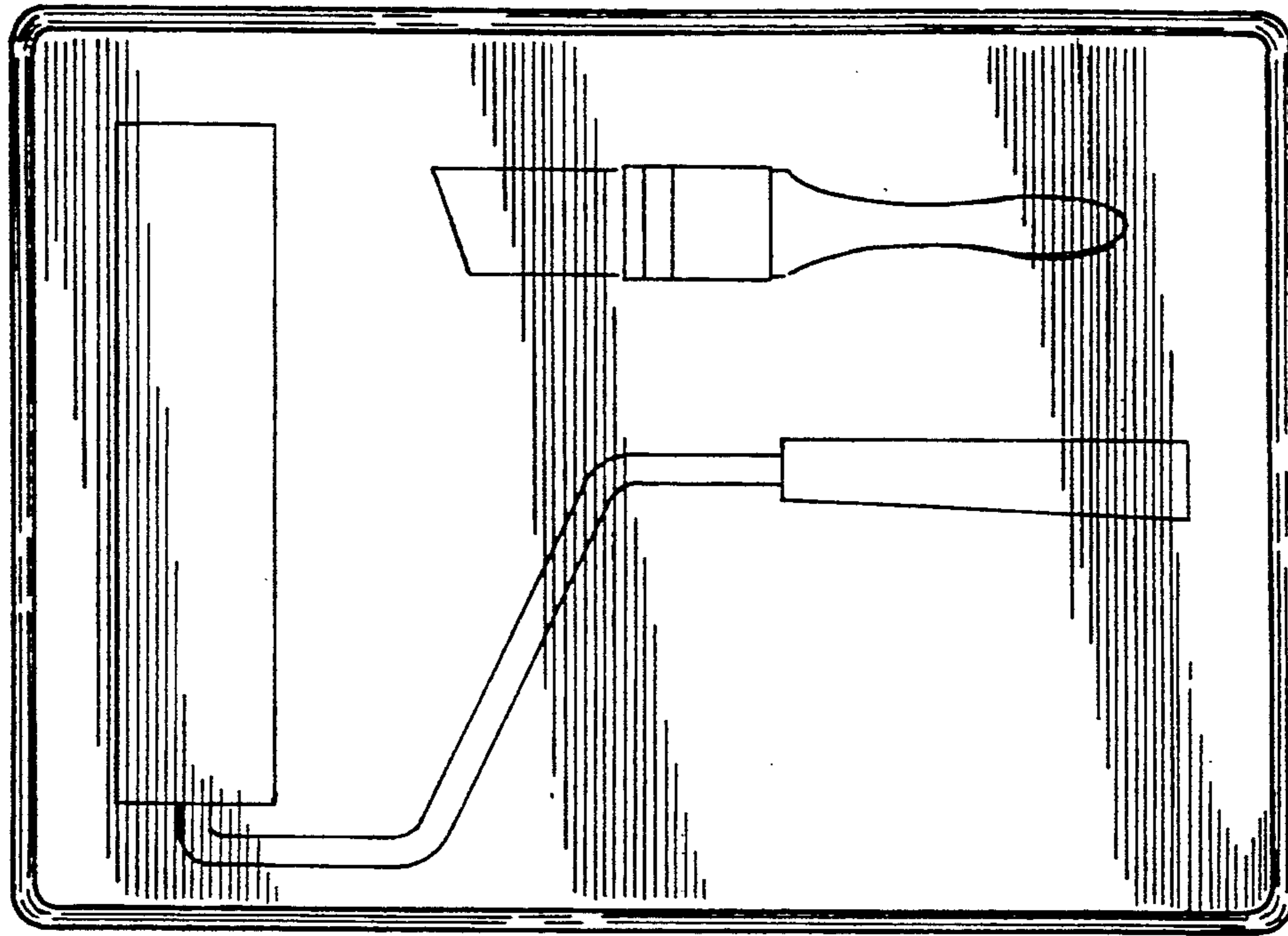

FIG. 6

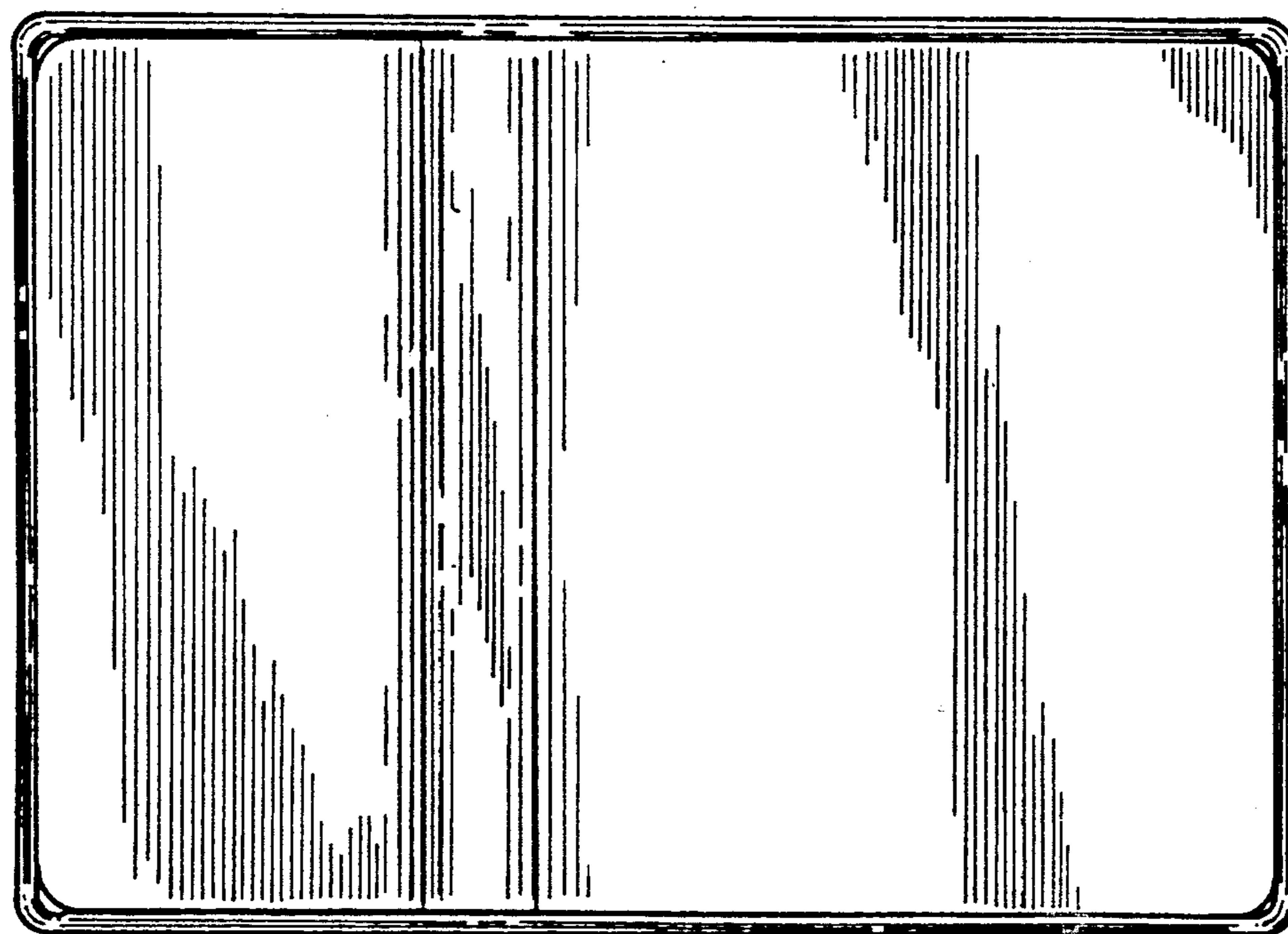

FIG. 7