



US00D327729S

United States Patent [19]

[11] Patent Number: **Des. 327,729**

Rogers

[45] Date of Patent: **** Jul. 7, 1992**

[54] **HAND HELD SHOWER**

[75] Inventor: **Daniel G. Rogers, Homer, Mich.**

[73] Assignee: **Alsons Corporation, Hillsdale, Mich.**

[**] Term: **14 Years**

[21] Appl. No.: **616,295**

[22] Filed: **Nov. 20, 1990**

[52] U.S. Cl. **D23/223**

[58] Field of Search **D23/213, 223-229;**
239/276, 280-281, 282-283, 288.5, 310,
443-449, 456-460, 525, 567, 581.1, 581.2, 583;
4/191-192, 567-570, 599-603, 596, 615

[56] **References Cited**

U.S. PATENT DOCUMENTS

D. 238,672	2/1976	McNari	D23/223
D. 245,856	9/1977	Grobe	D23/223
D. 261,300	10/1981	Kloze	D23/223
D. 289,545	4/1987	Koch	D23/223

D. 295,437	4/1988	Fabian	D23/223
D. 309,773	8/1990	Huen	D23/223
4,224,700	9/1980	Bloys	4/603
4,674,687	6/1987	Smith et al.	239/525 X

Primary Examiner—Susan J. Lucas
Assistant Examiner—M. H. Tung
Attorney, Agent, or Firm—Myron B. Kapustij; Edgar A. Zarins; Malcolm L. Sutherland

[57] CLAIM

The ornamental design for a hand held shower, as shown and described.

DESCRIPTION

FIG. 1 is a bottom, front, right side perspective view of a hand held shower showing my new design; FIG. 2 is a right side elevational view thereof, the left side being a mirror image; FIG. 3 is a top plan view thereof; FIG. 4 is a bottom plan view thereof; FIG. 5 is a front elevational view thereof; and, FIG. 6 is a rear elevational view thereof.

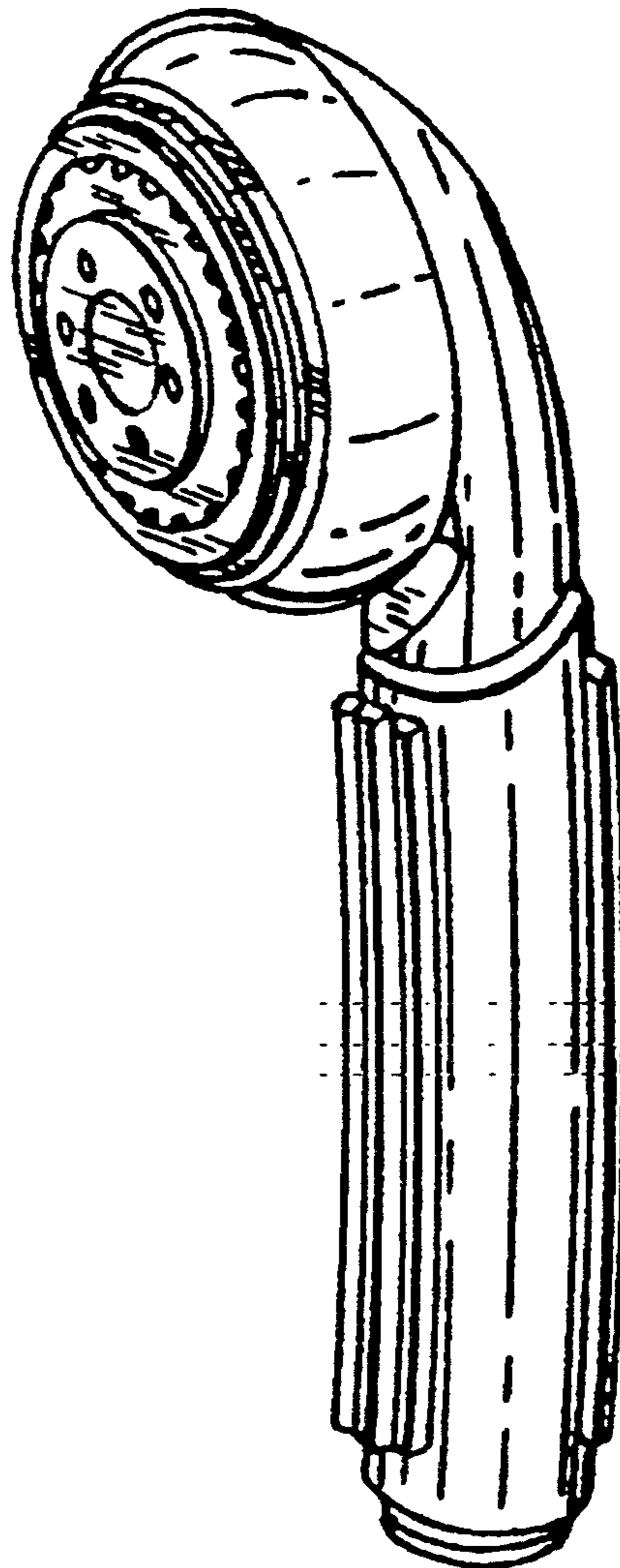

FIG. 1.

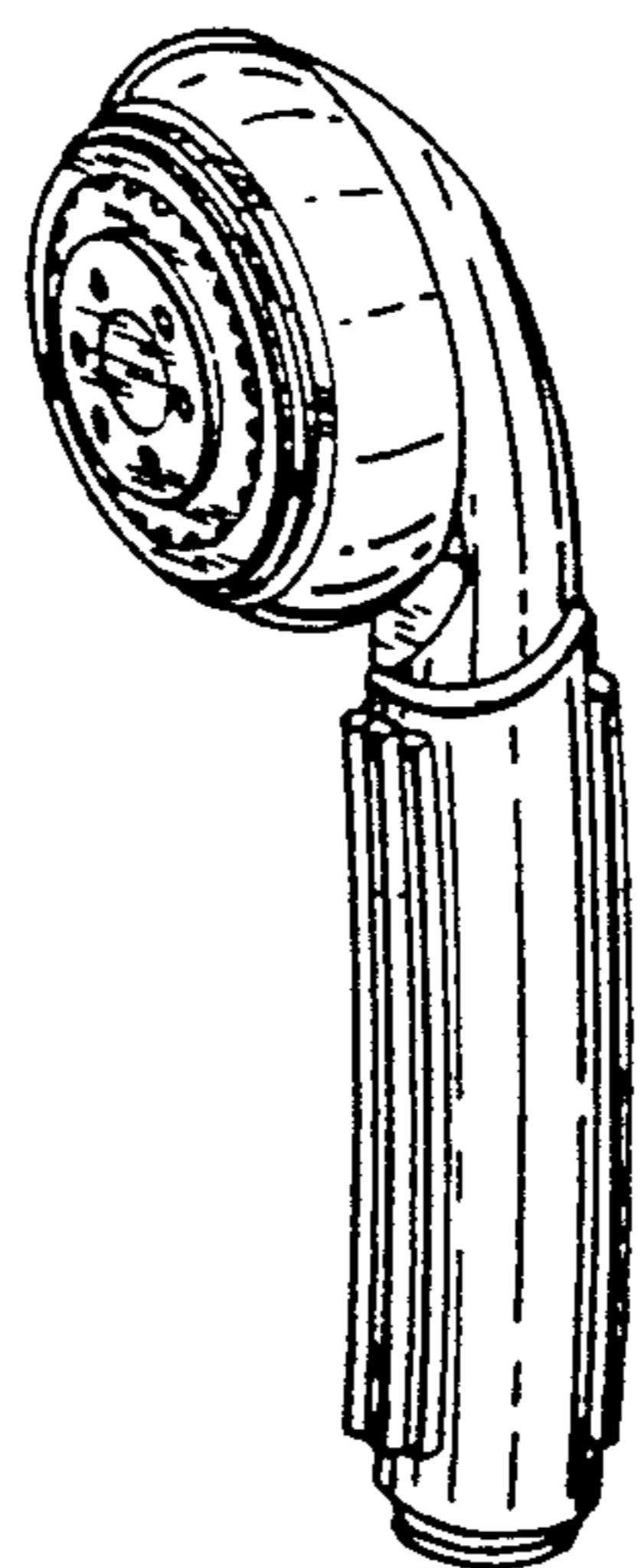

FIG. 2.

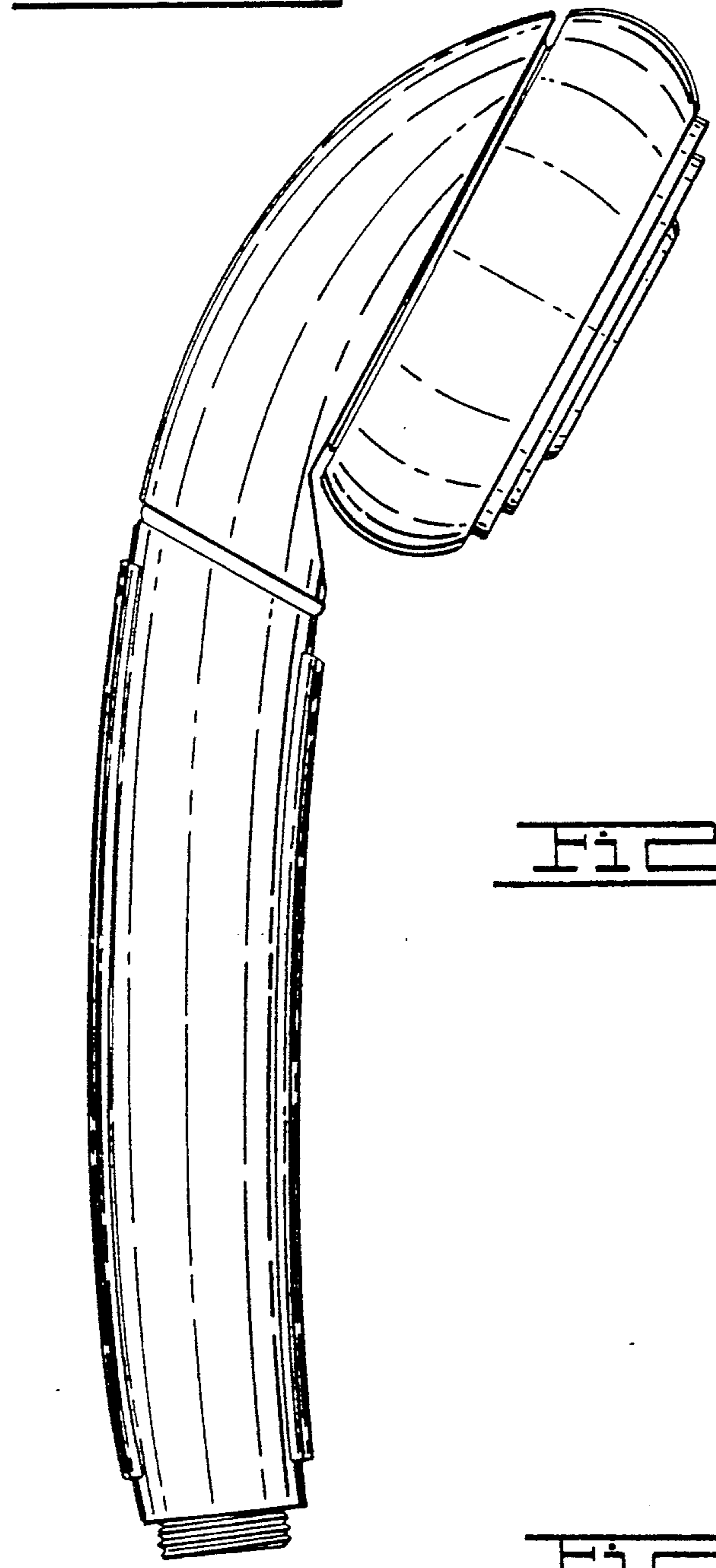

FIG. 3.

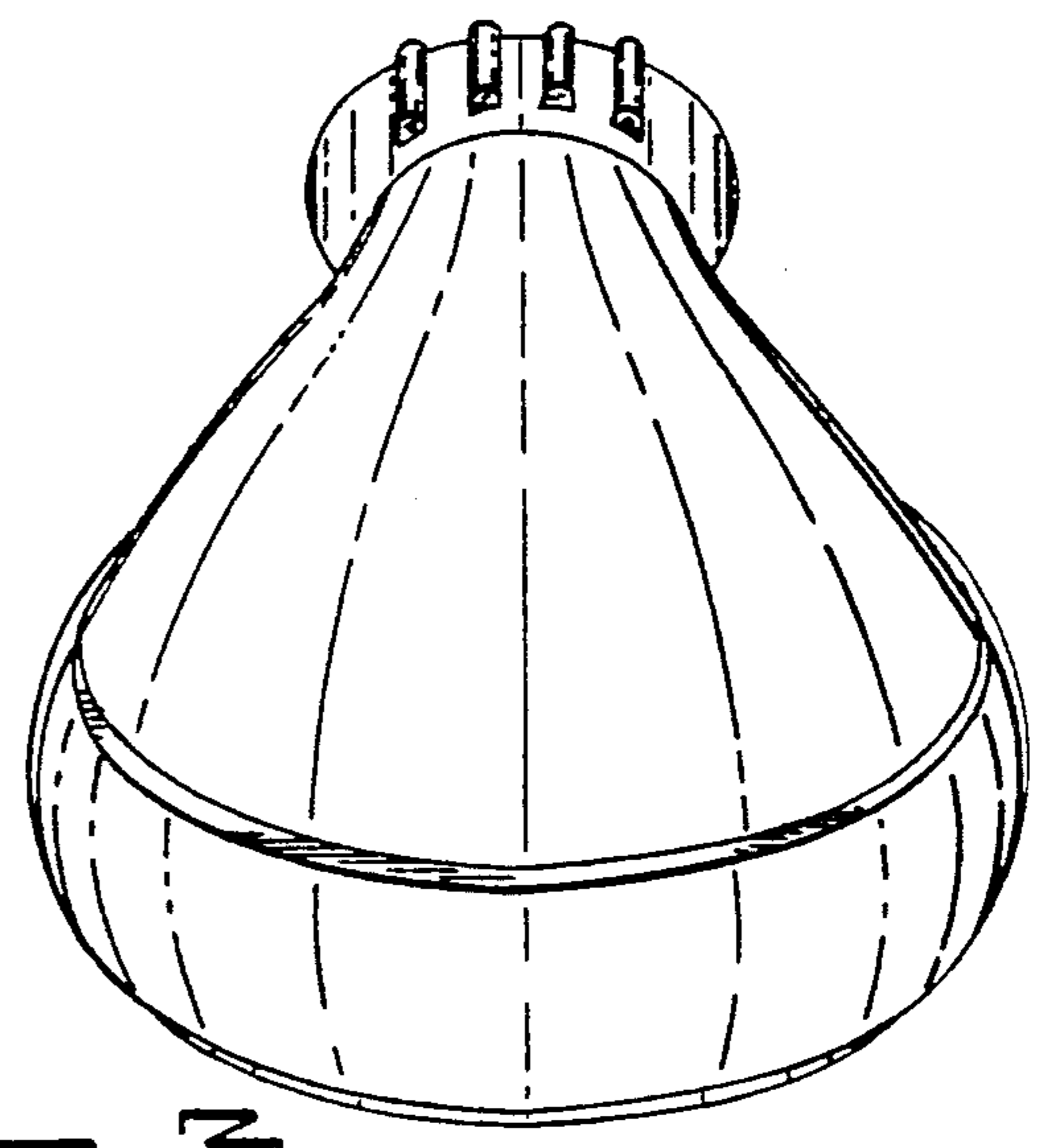
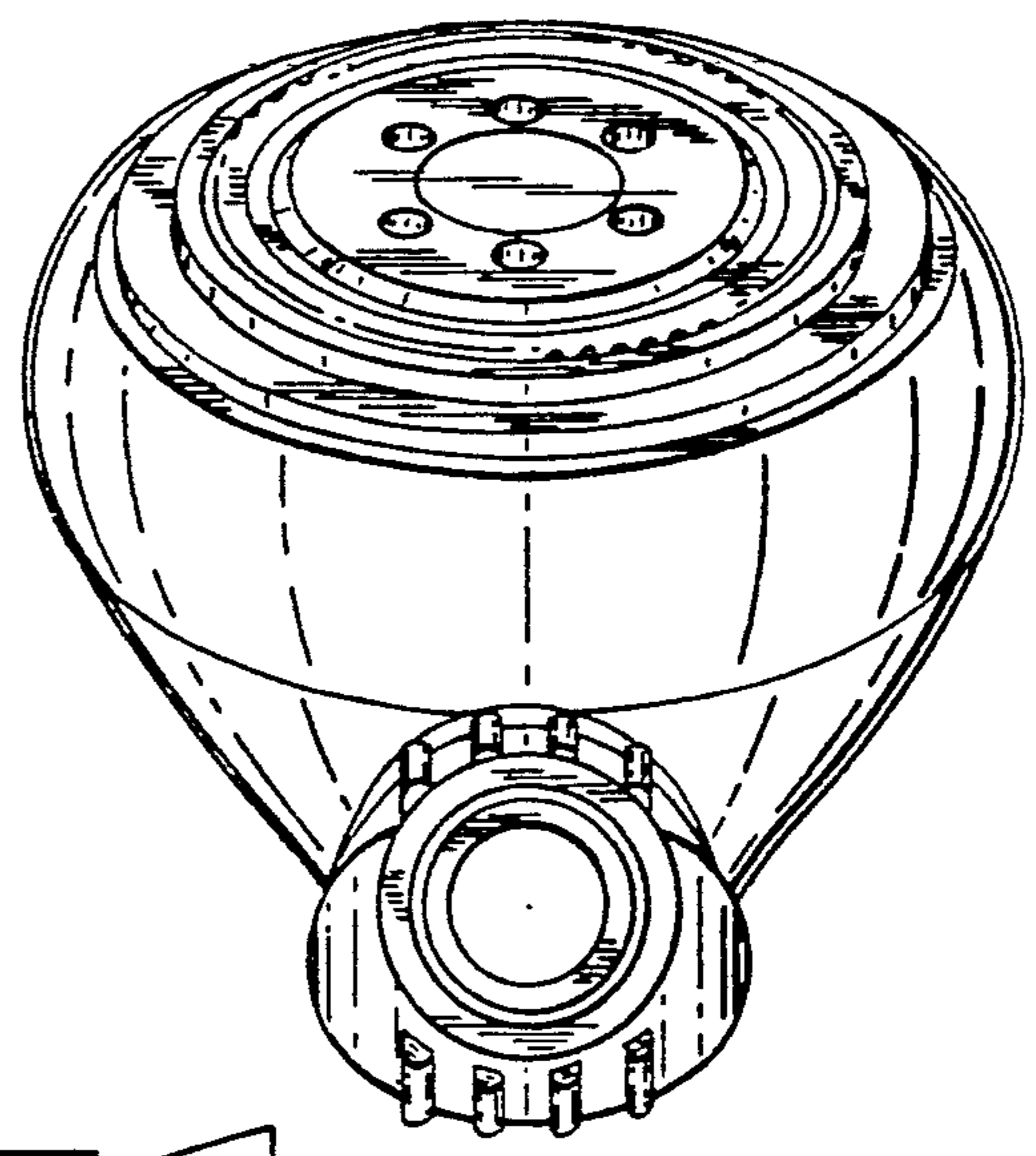

FIG. 4.



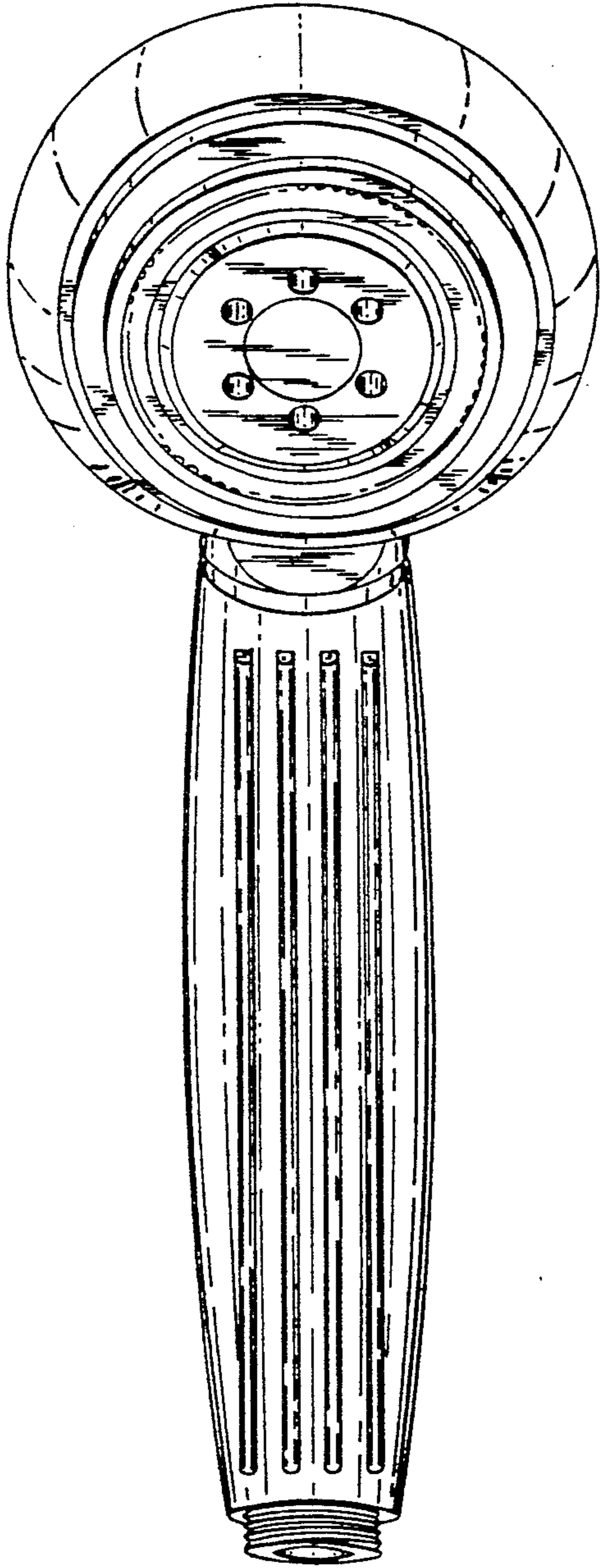

FIG. 5.

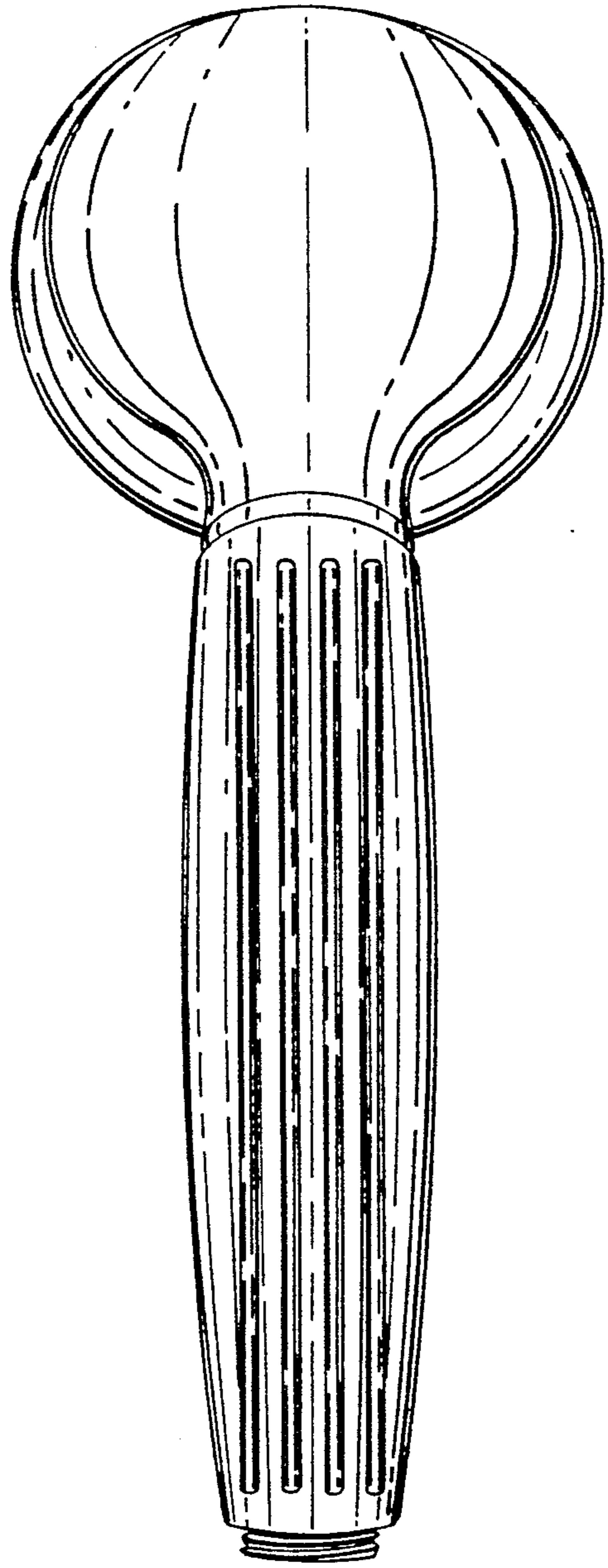

FIG. 6.