



US00D327592S

# United States Patent [19]

Kerem

[11] Patent Number: **Des. 327,592**

[45] Date of Patent: **\*\* Jul. 7, 1992**

[54] TABLE

[75] Inventor: **Eitan Kerem, Western Galilee, Israel**

[73] Assignees: **Bitro International Marketing, Inc., Lakewood, N.J.; Polyziv, Israel**

[\*\*] Term: **14 Years**

[21] Appl. No.: **310,711**

[22] Filed: **Feb. 15, 1989**

[52] U.S. Cl. .... **D6/480; D6/484**

[58] Field of Search ..... **D6/480, 482-489, D6/495-499, 429, 430**

[56] **References Cited**

**U.S. PATENT DOCUMENTS**

- D. 178,621 8/1956 van Koert ..... D6/480
- D. 215,858 11/1969 Hamilten ..... D6/485
- D. 239,584 4/1976 Vrignaud ..... D6/484

D. 312,736 12/1990 Grosfillex ..... D6/349

*Primary Examiner*—Donald P. Walsh  
*Assistant Examiner*—Janice E. Seeger  
*Attorney, Agent, or Firm*—Arthur L. Plevy

[57] **CLAIM**

The ornamental design for a table, as shown and described.

**DESCRIPTION**

FIG. 1 is a perspective view of a table, showing my new design;

FIG. 2 is an end elevational view;

FIG. 3 is a side elevational view;

FIG. 4 is a top plan view;

FIG. 5 is a bottom plan view; and,

FIG. 6 is a cross-sectional view, taken along line 6—6 in FIG. 5.

FIGS. 2-6 have been drawn to an enlarged scale with respect to FIG. 1.

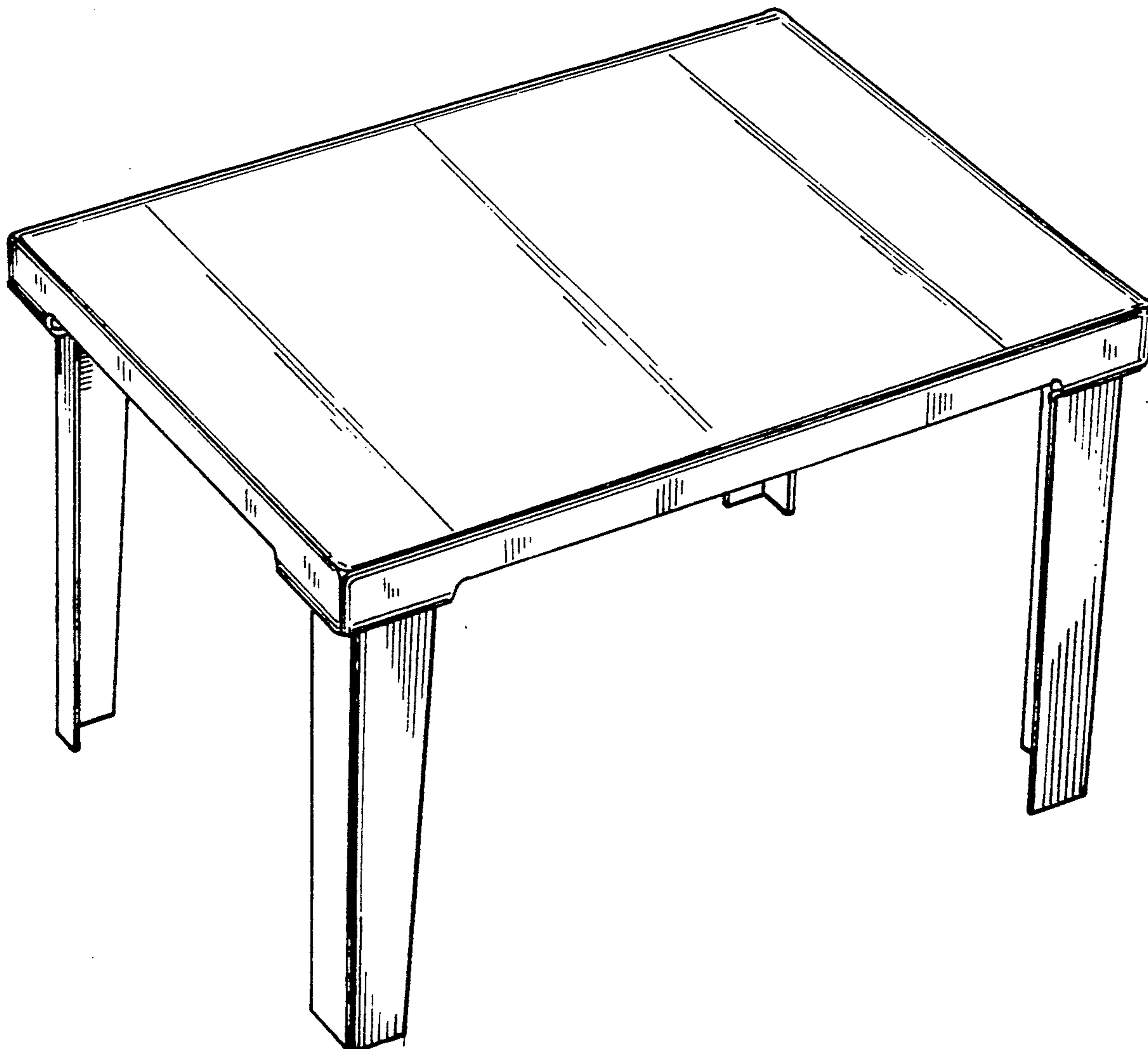

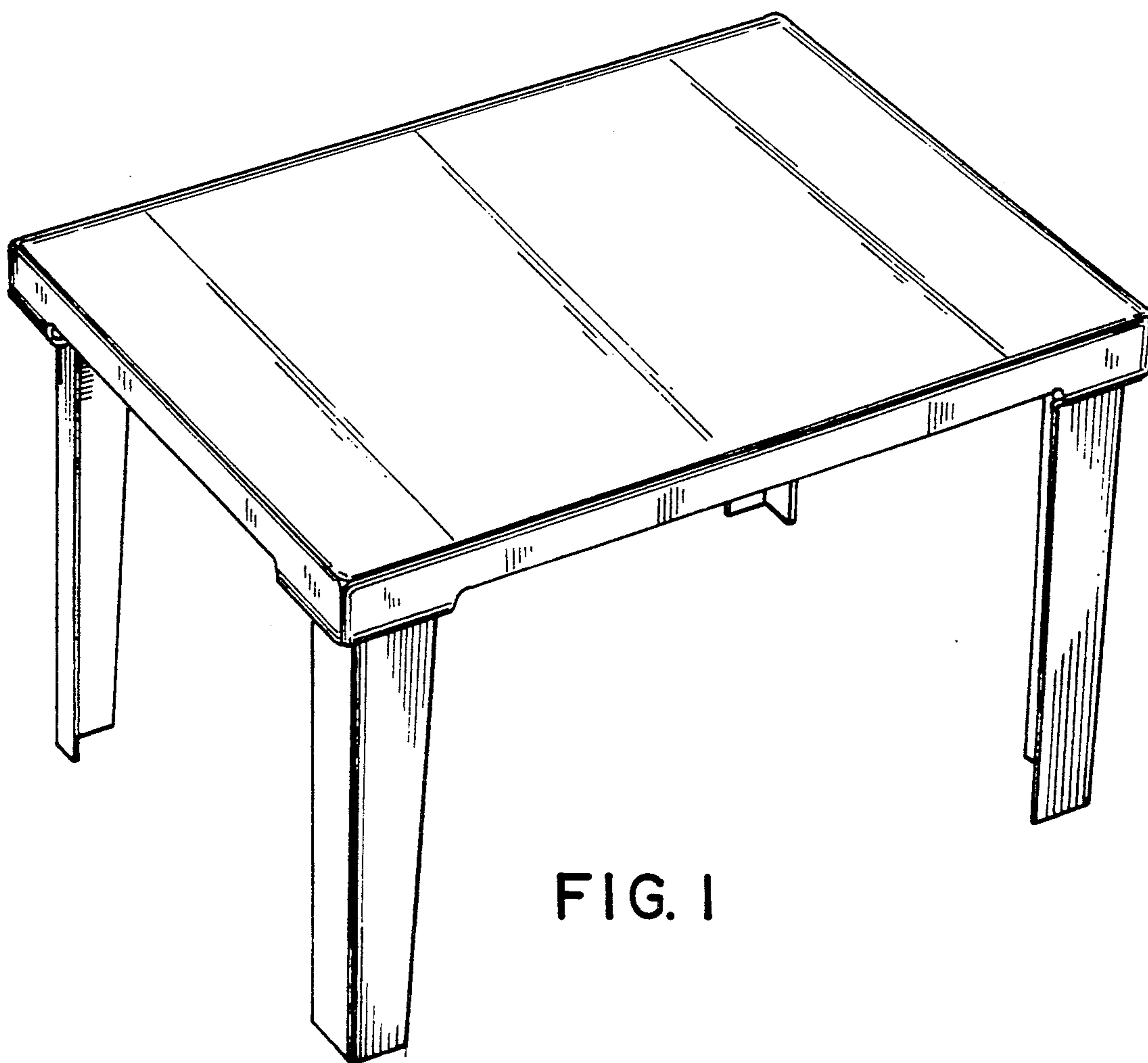

FIG. 1

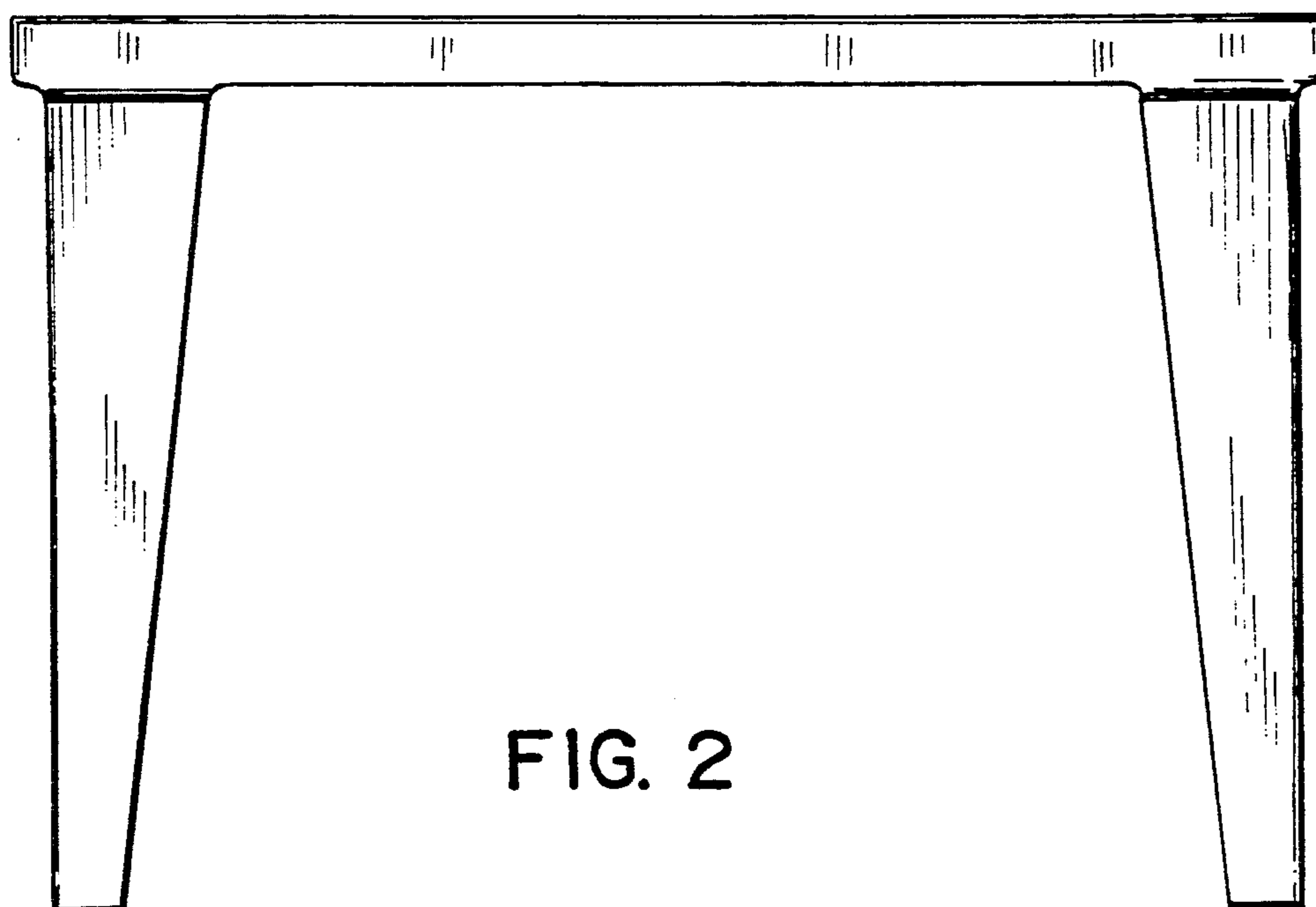

FIG. 2

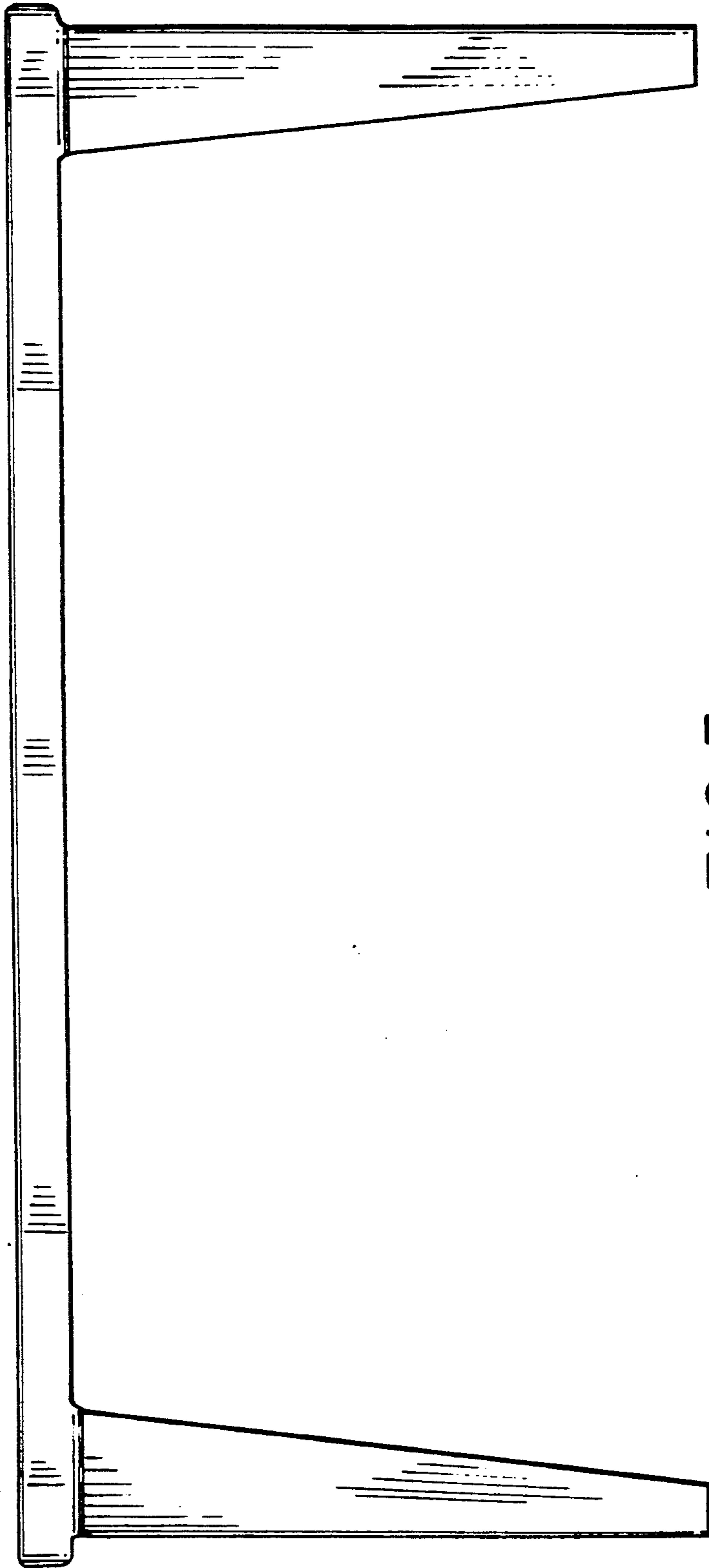

FIG. 3

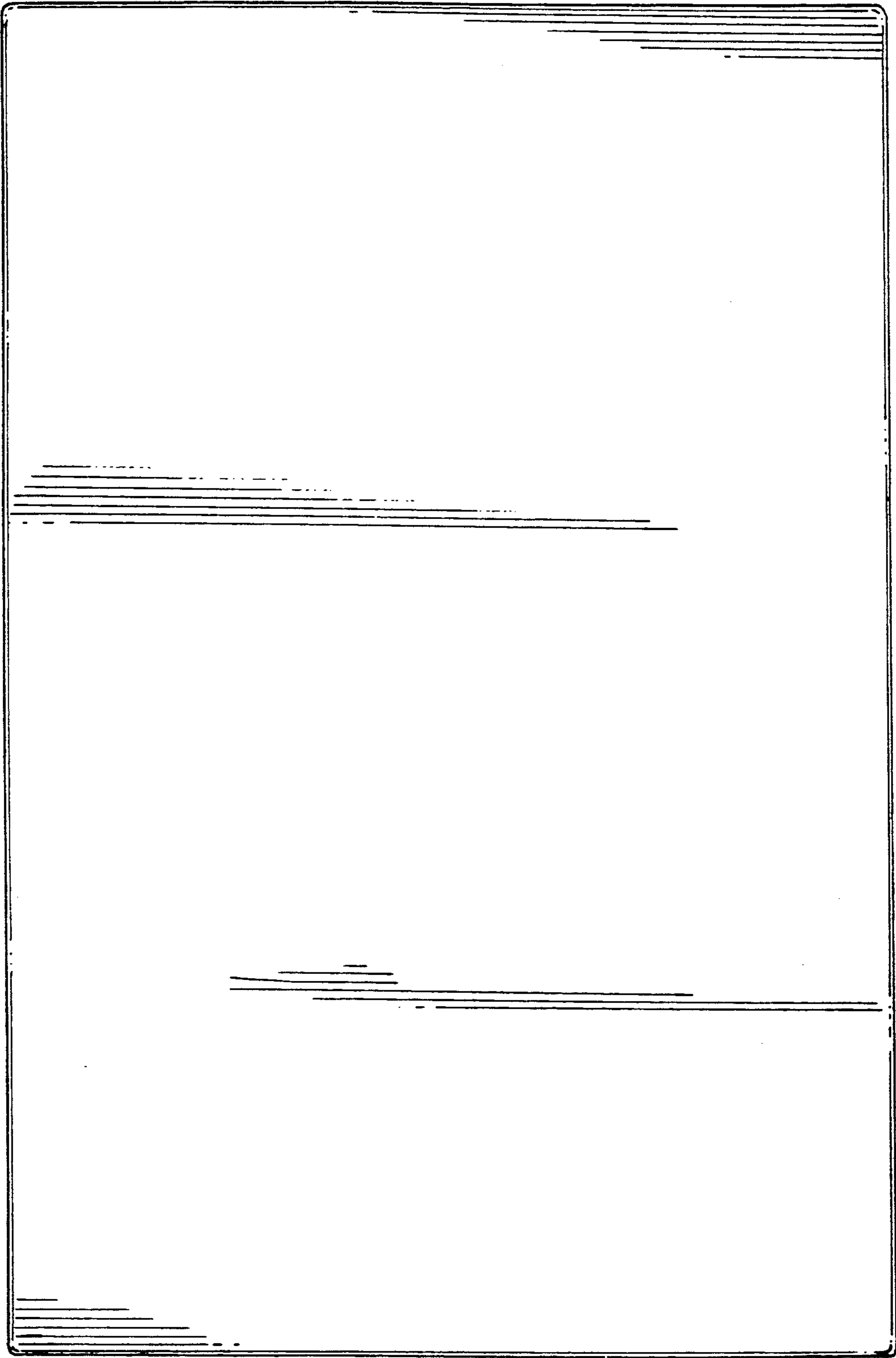
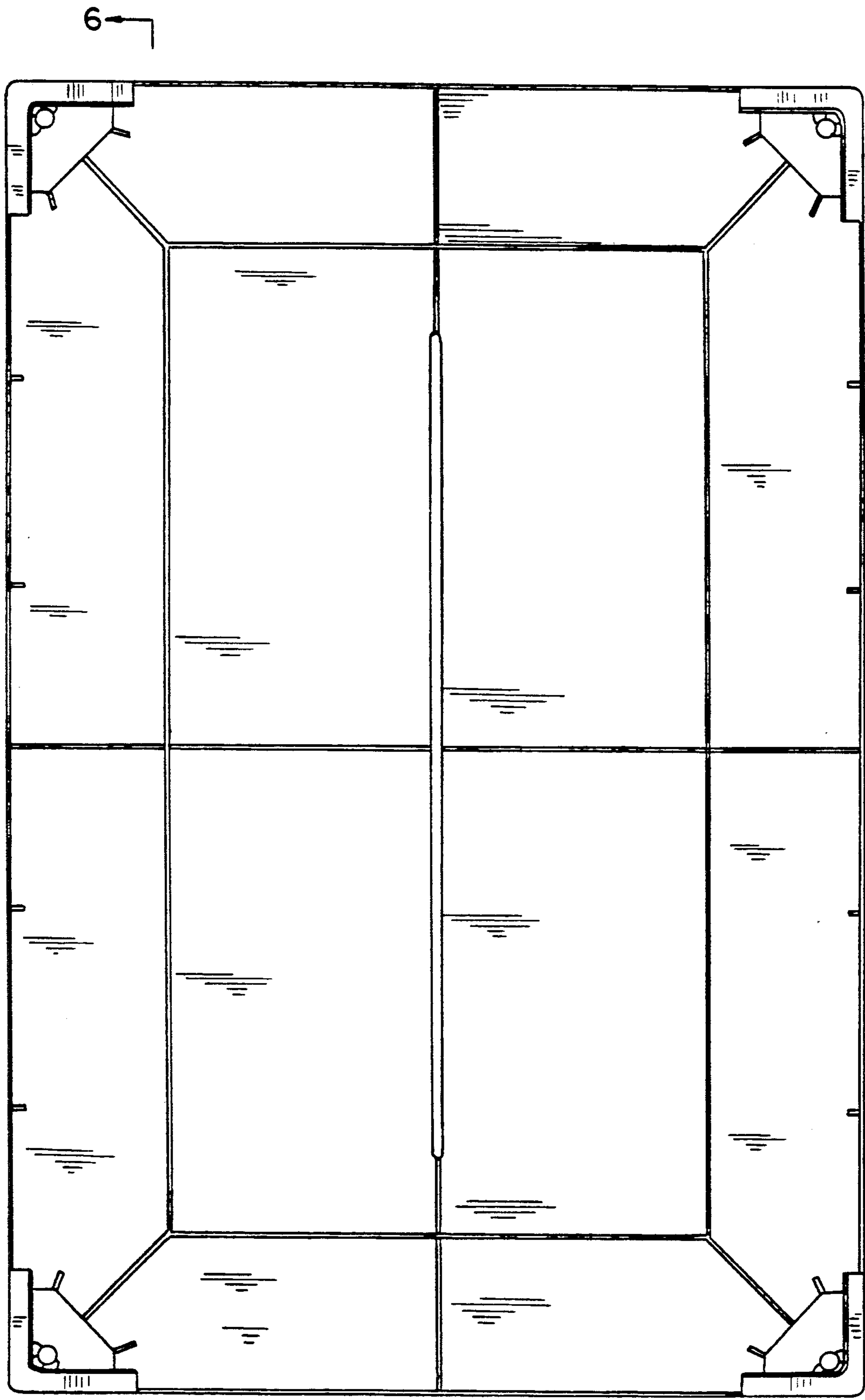

FIG. 4



6 ←

FIG. 5

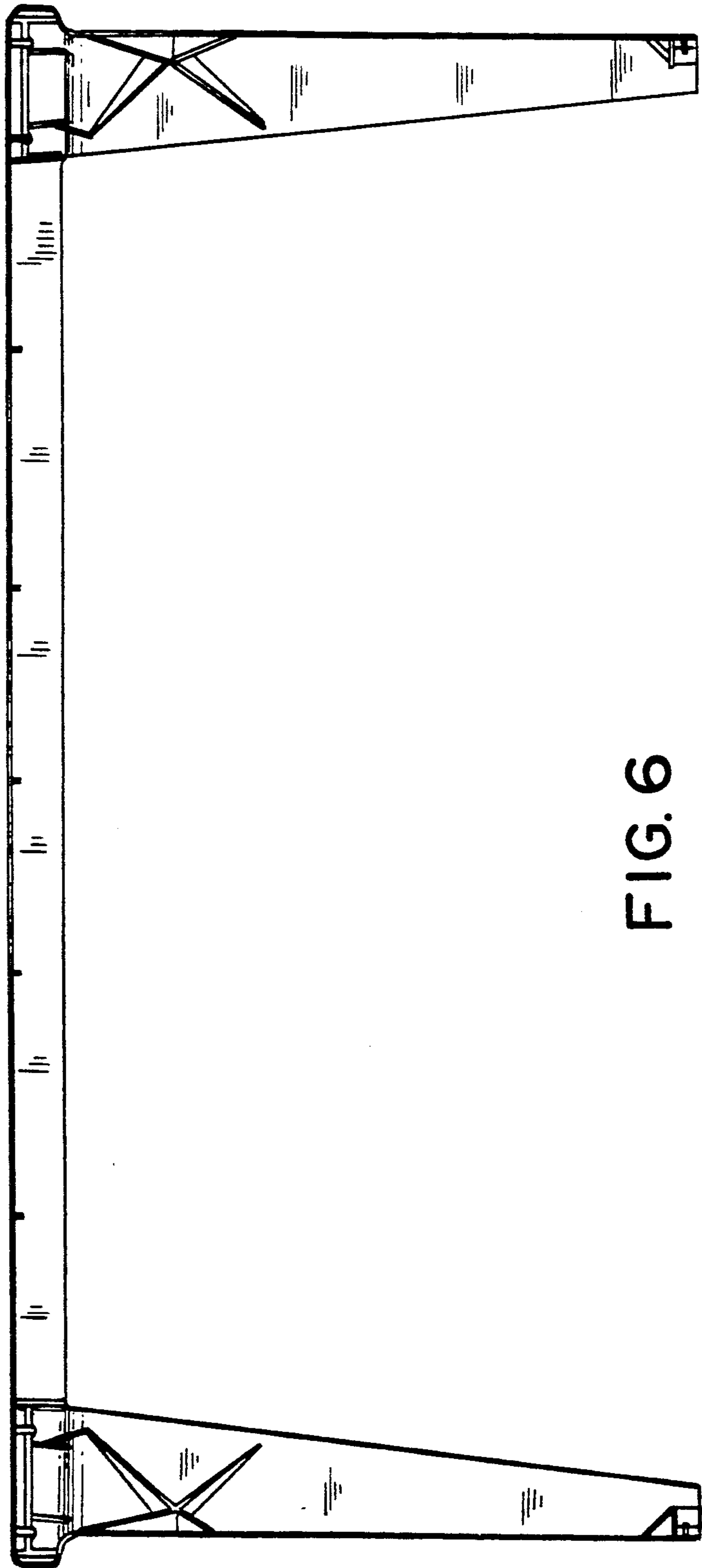

FIG. 6