



US00D327583S

United States Patent [19]

[11] Patent Number: **Des. 327,583**

Dettinger

[45] Date of Patent: **** Jul. 7, 1992**

[54] SEAT

[76] Inventor: **Ernst M. Dettinger, Maria Eich**
Strasse 52A, D-8032 Graefelfing B.
Munchen, Fed. Rep. of Germany

[**] Term: **14 Years**

[21] Appl. No.: **327,957**

[22] Filed: **Mar. 23, 1989**

[52] U.S. Cl. **D6/334; D6/381**

[58] Field of Search **D6/334, 335, 375, 381,**
D6/500

[56] **References Cited**

U.S. PATENT DOCUMENTS

D. 80,599	3/1930	Bernhard	D6/381
D. 132,944	7/1942	Jackson	D6/381
D. 245,953	10/1977	Mathur	D6/334
D. 252,484	7/1979	Petersilie	D6/381
D. 255,846	7/1980	Bick	D6/334
D. 303,326	9/1989	Heimberger	D6/334
D. 314,473	2/1991	Culler	D6/381 X
3,002,787	10/1961	Ziegenfuss	D6/381 X

OTHER PUBLICATIONS

Carsons, Chair #57155 at left.
Interiors, Jul. 1986, p. 182, Chair at bottom left.
Schoner Wohnen, Jun. 1987, p. 20, Chair at mid-page left.

Primary Examiner—Donald P. Walsh
Assistant Examiner—Gary D. Watson
Attorney, Agent, or Firm—Rhodes, Coats & Bennett

[57] **CLAIM**

The ornamental design for a seat, as shown and described.

DESCRIPTION

FIG. 1 is a perspective view of a seat showing my new design in the form of a chair;
FIG. 2 is a front elevational view;
FIG. 3 is a left side elevational view, the right side being a mirror image thereof;
FIG. 4 is a rear elevational view;
FIG. 5 is a left side perspective view of a seat showing my new design in the form of a loveseat, the right side being a mirror image thereof;
FIG. 6 is a front elevational view of FIG. 5; and,
FIG. 7 is a rear elevational view of FIG. 5.

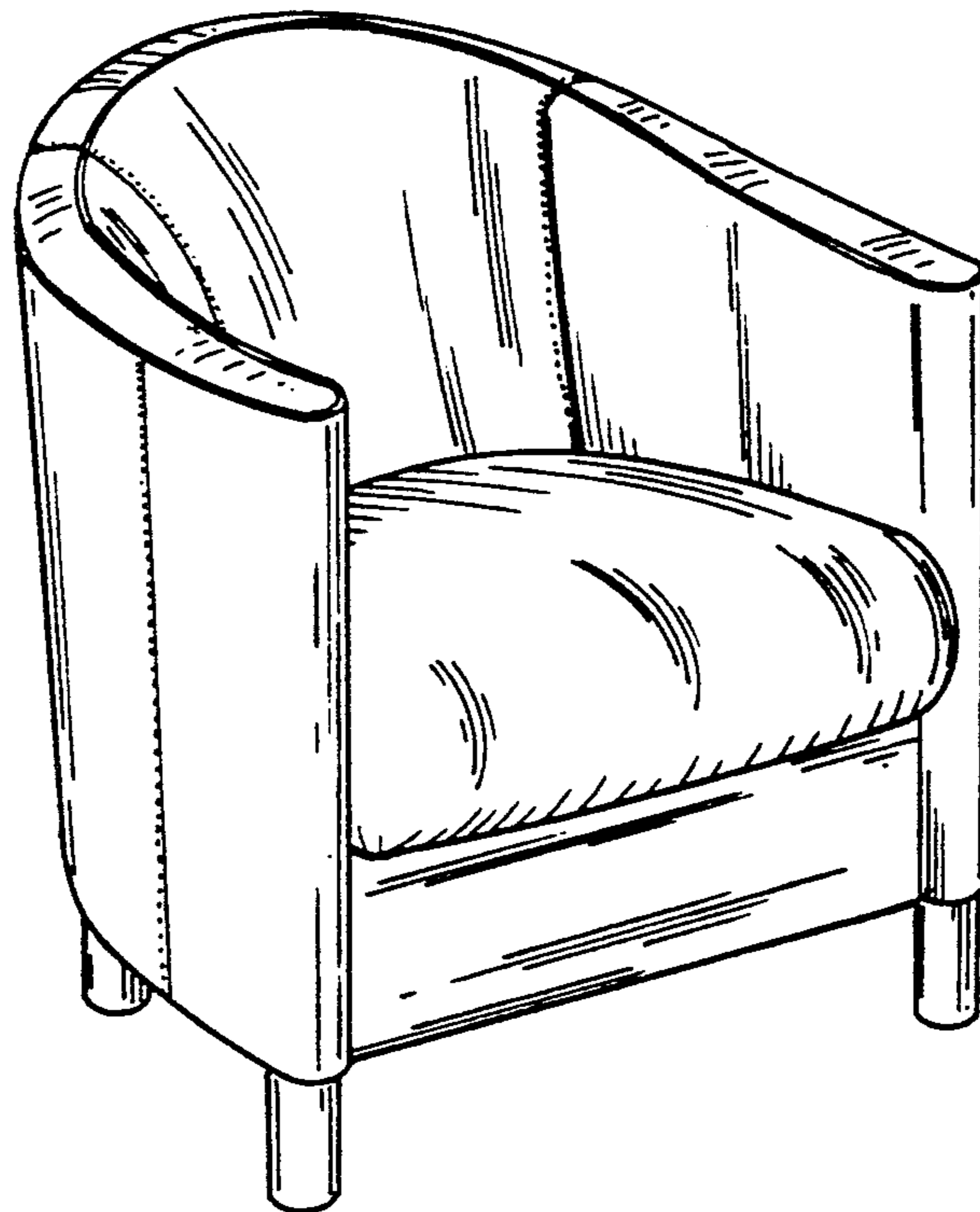

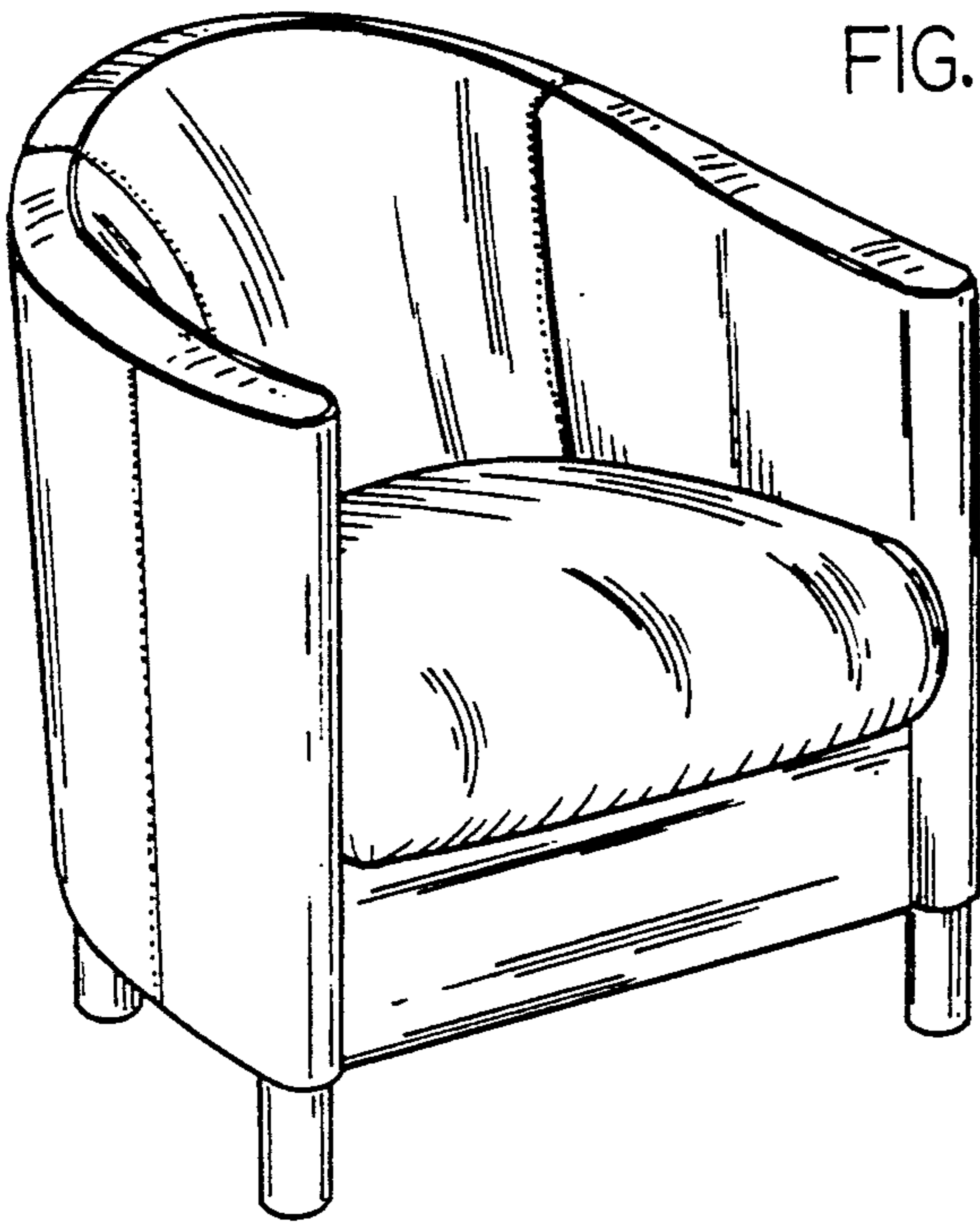

FIG. 1

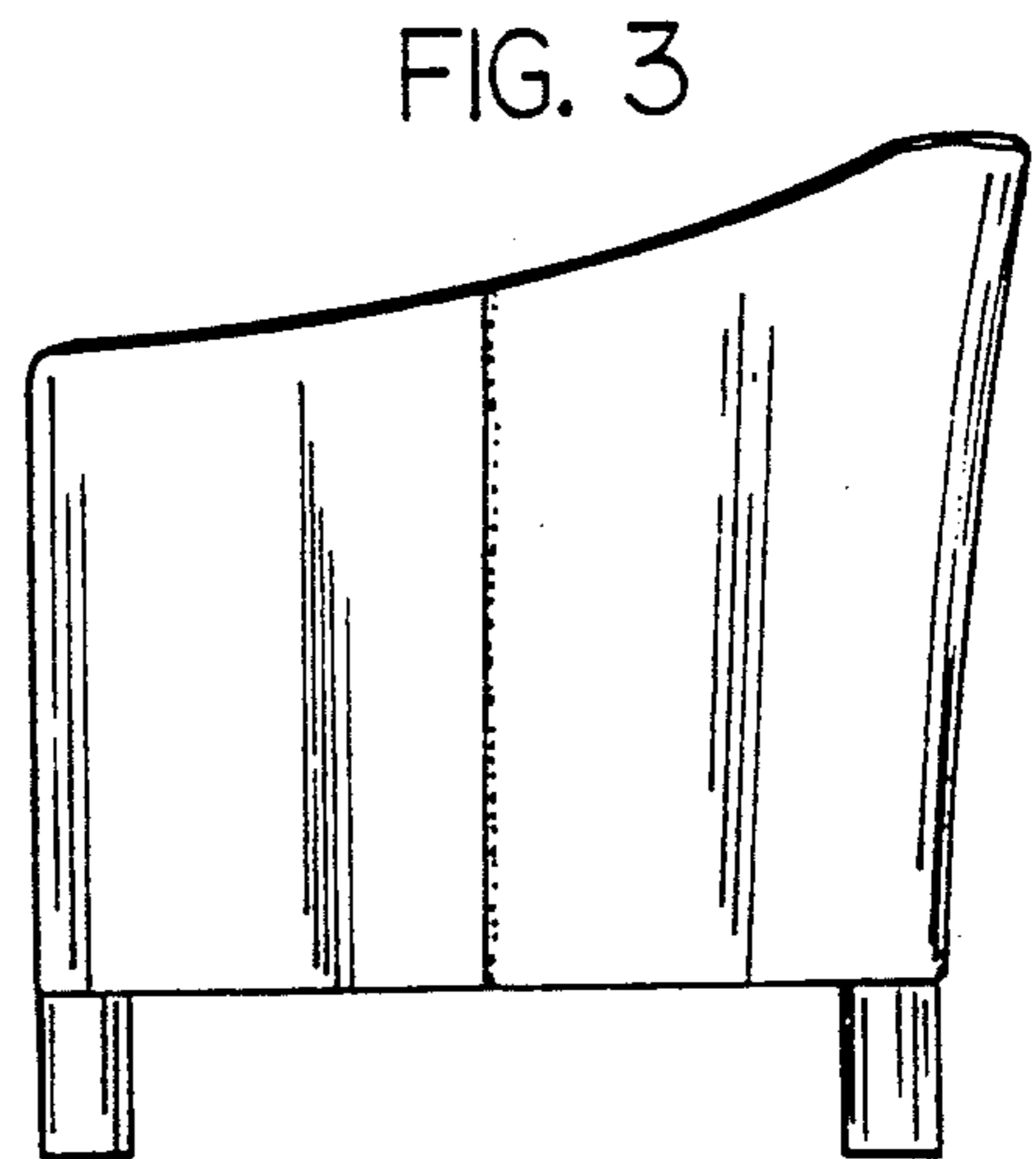

FIG. 3

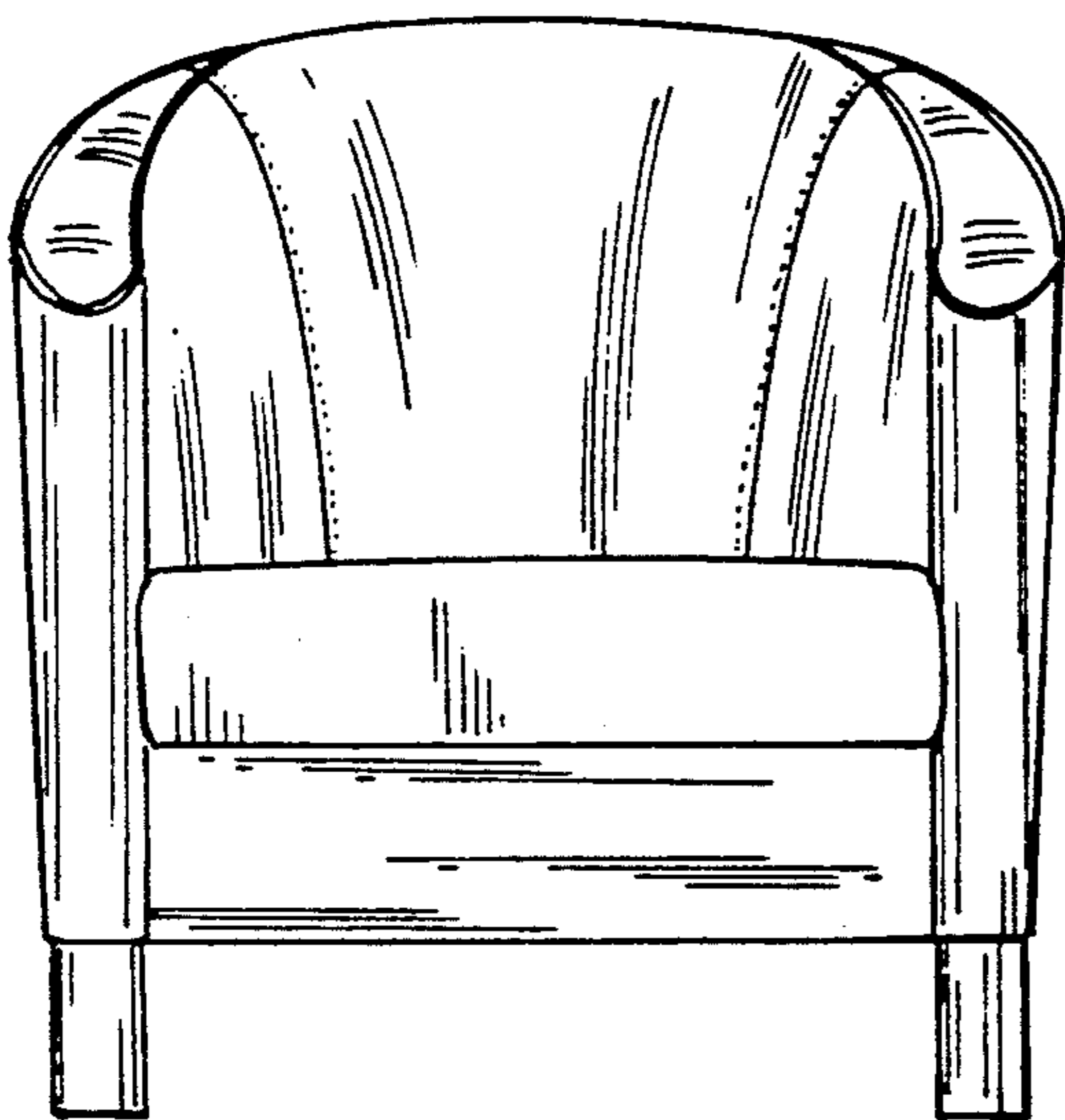

FIG. 2

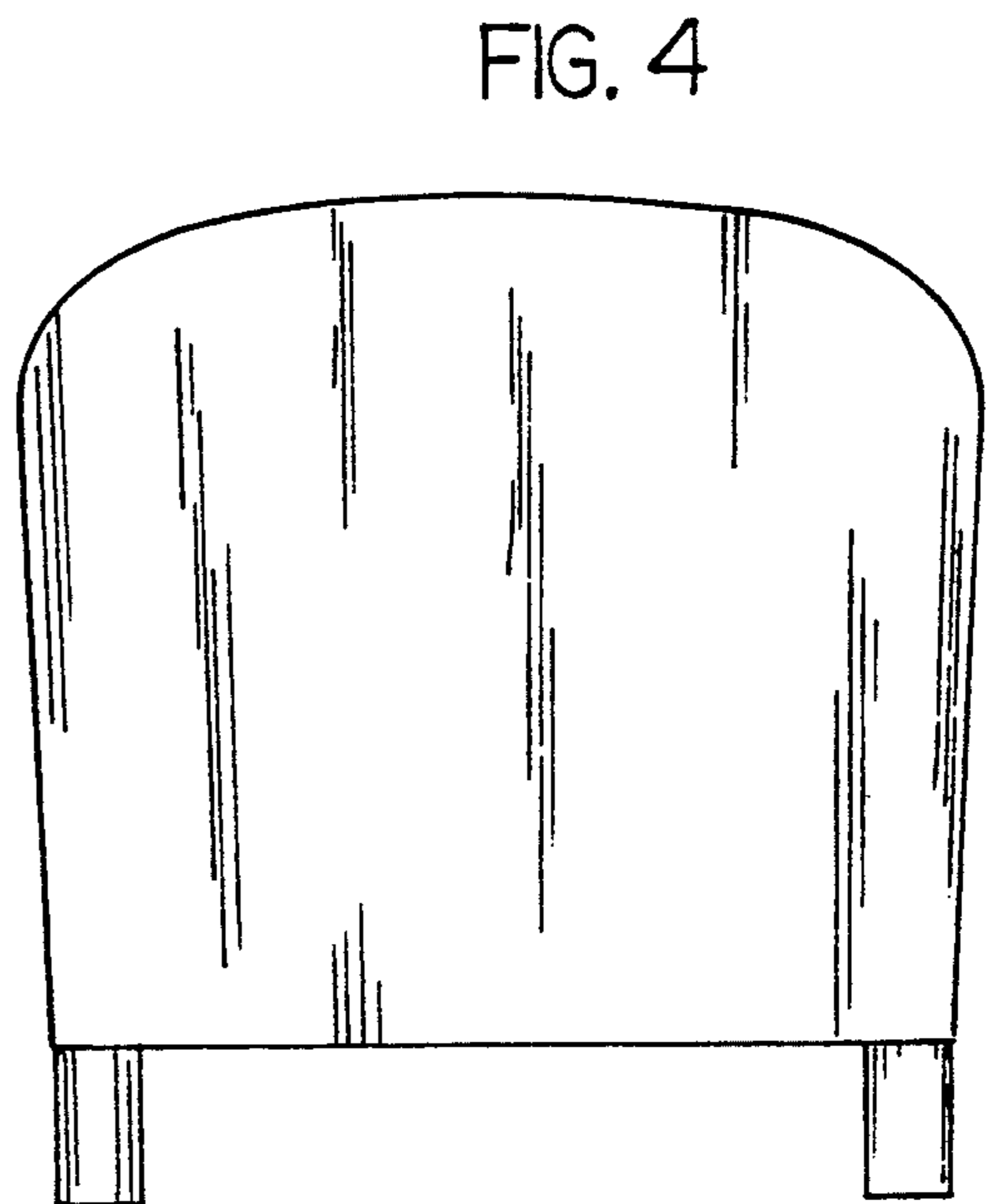

FIG. 4

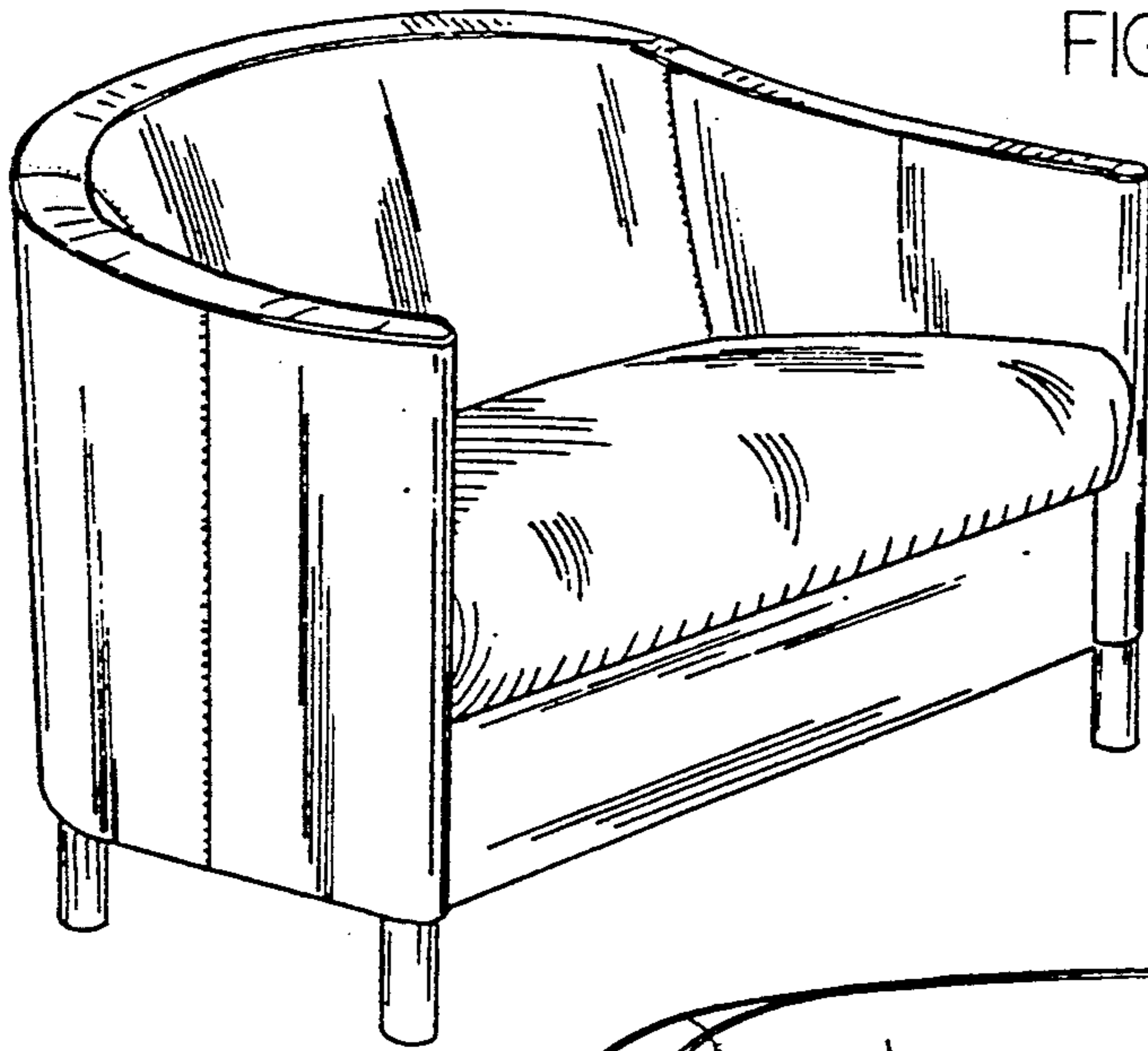

FIG. 5

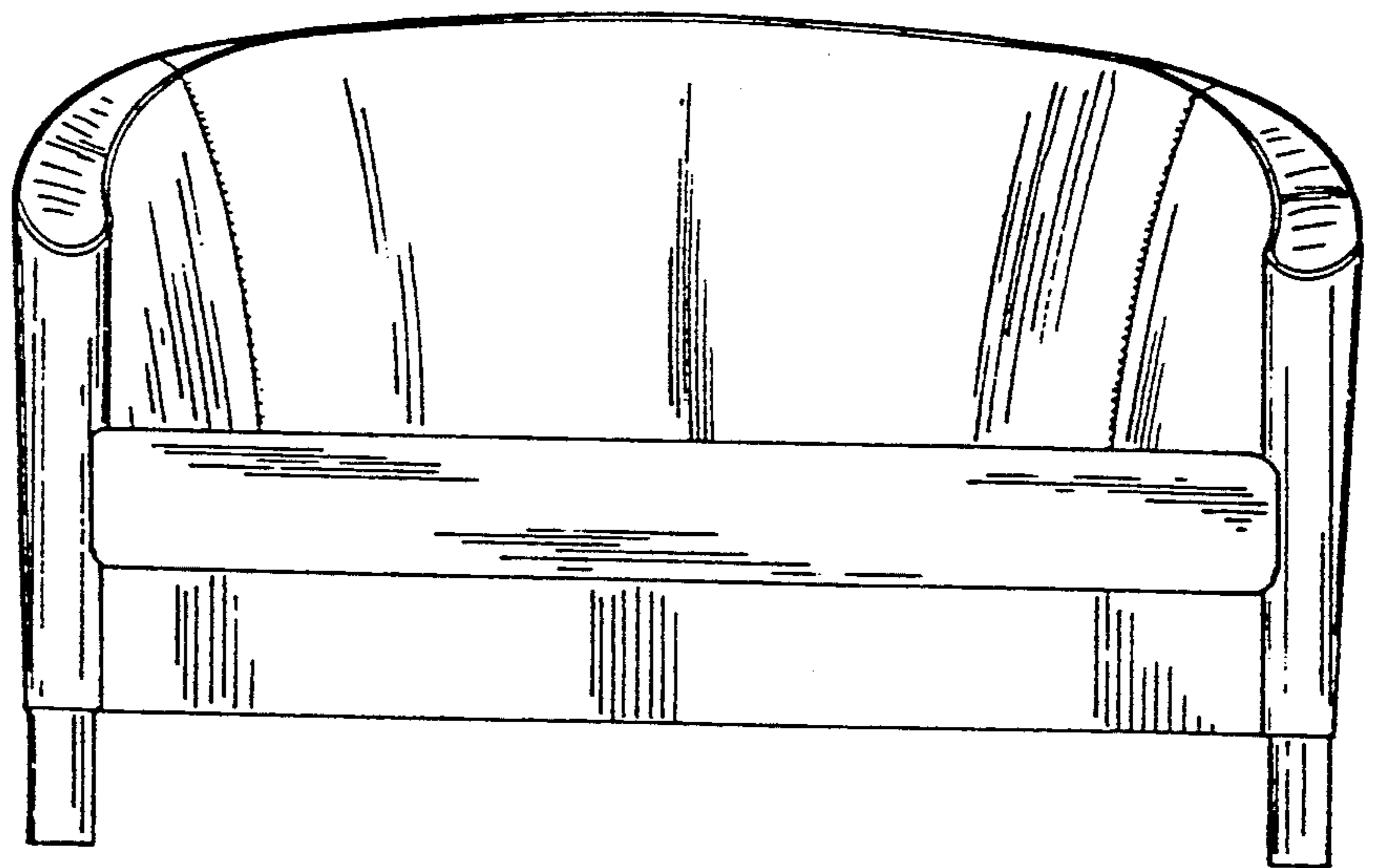

FIG. 6

FIG. 7

