



US00D327524S

**United States Patent** [19]  
**Kim**

[11] **Patent Number: Des. 327,524**

[45] **Date of Patent: \*\* Jun. 30, 1992**

[54] **COMBINED TENT SHELTER AND MAT THEREFOR**

[76] **Inventor: Min S. Kim**, Suite 602, Yoohwa Bldg., 996-16 Daechi-Dong, Kangnam-ku, Seoul, Rep. of Korea

[\*\*] **Term: 14 Years**

[21] **Appl. No.: 453,457**

[22] **Filed: Dec. 19, 1989**

[30] **Foreign Application Priority Data**

Oct. 24, 1989 [KR] Rep. of Korea ..... 14251

[52] **U.S. Cl. .... D21/253**

[58] **Field of Search .... D21/253-255; 135/87, 95, 99, 117, DIG. 8**

[56] **References Cited**

**U.S. PATENT DOCUMENTS**

D. 304,966	12/1989	Eppenbach	.....	D21/253
2,167,219	7/1939	Sankey	.....	D21/253
2,475,515	7/1949	Potter	.....	D21/253
3,699,986	10/1972	Kirkham	.....	135/87
3,726,294	4/1973	Huddle	.....	135/117
4,128,104	12/1978	Corey	.....	135/117
4,784,172	11/1988	Yacoboni	.....	135/87
4,858,635	8/1989	Eppenbach	.....	135/117

**OTHER PUBLICATIONS**

Photocopies of four photographs of sun shelters bearing "LARK", SONY and COCA-COLA trademarks.

*Primary Examiner*—Charles A. Rademaker  
*Attorney, Agent, or Firm*—Barrigar & Oyen

[57] **CLAIM**

The ornamental design for a combined tent shelter and mat therefor, as shown and described.

**DESCRIPTION**

FIG. 1 is a front perspective view of a combined tent shelter and mat therefor showing my new design;  
 FIG. 2 is another front perspective view thereof with the flaps in an open condition;  
 FIG. 3 is another front perspective view thereof with the front flap in a rolled-up condition;  
 FIG. 4 is a top plan view of the design as shown in FIG. 1;  
 FIG. 5 is a bottom plan view thereof;  
 FIG. 6 is a front elevation view thereof;  
 FIG. 7 is an end elevational view thereof;  
 FIG. 8 is a cross-sectional view thereof taken along line 8—8 of FIG. 4; and,  
 FIG. 9 is a cross-sectional view thereof taken along line 9—9 of FIG. 4.

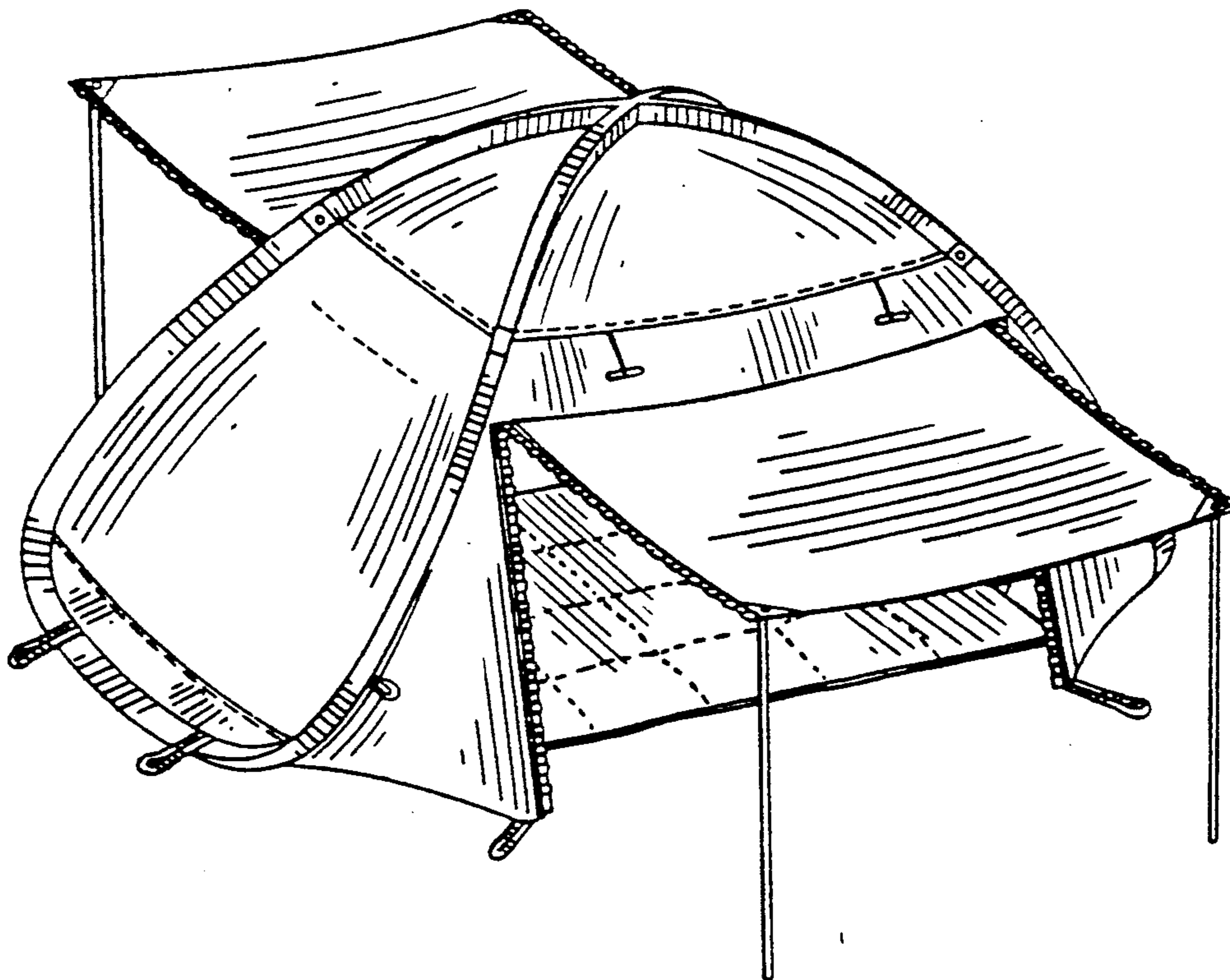

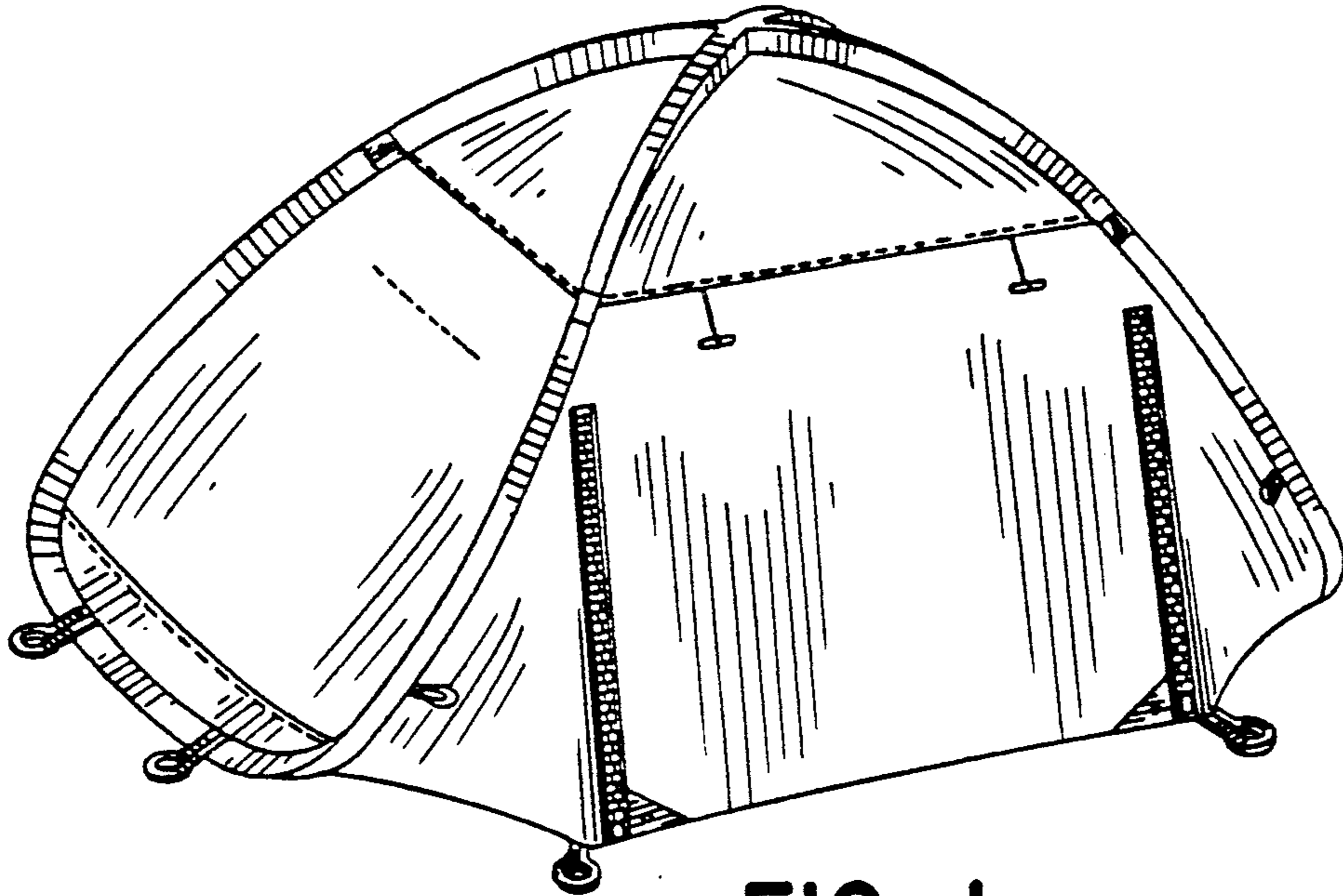

FIG. 1

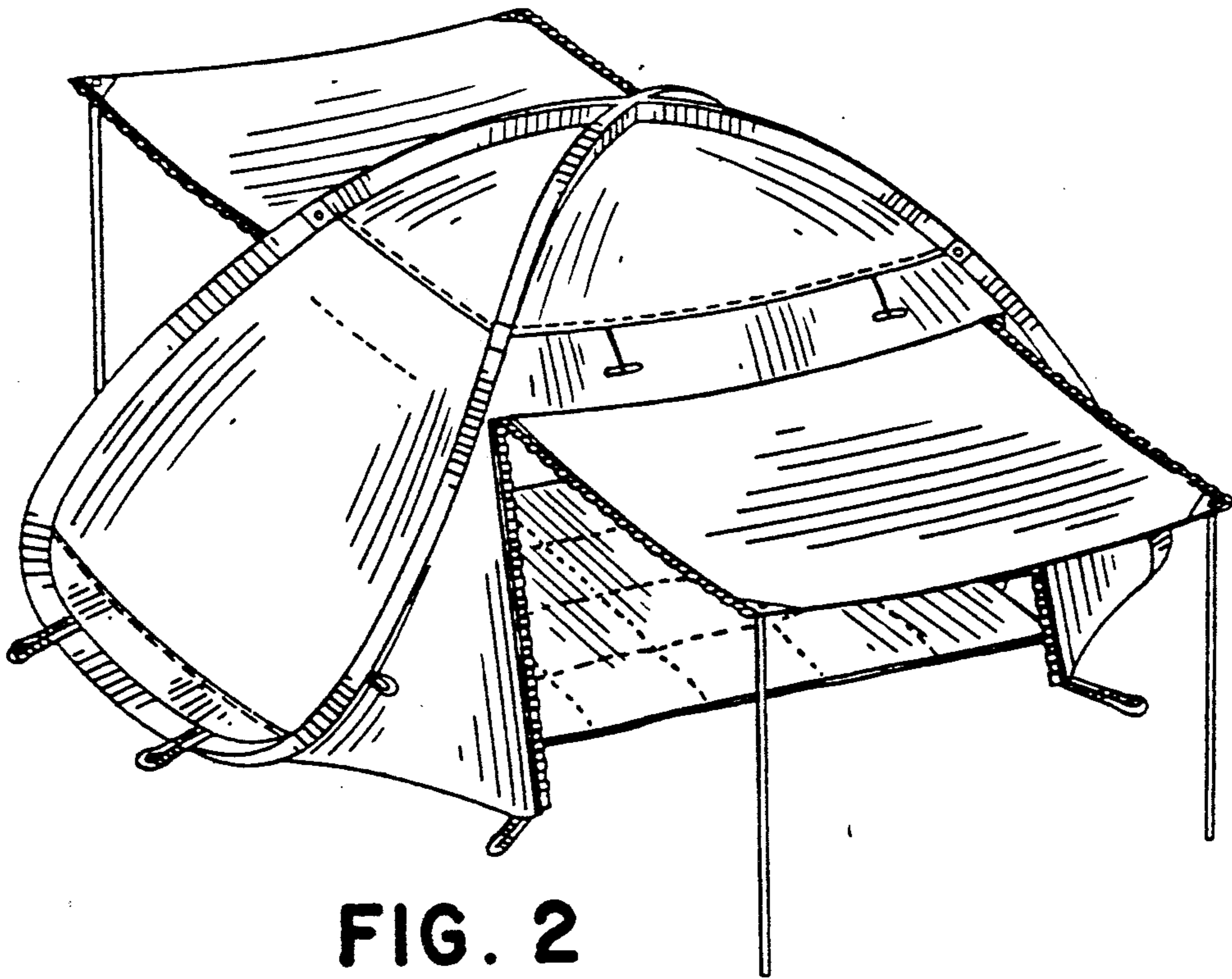

FIG. 2

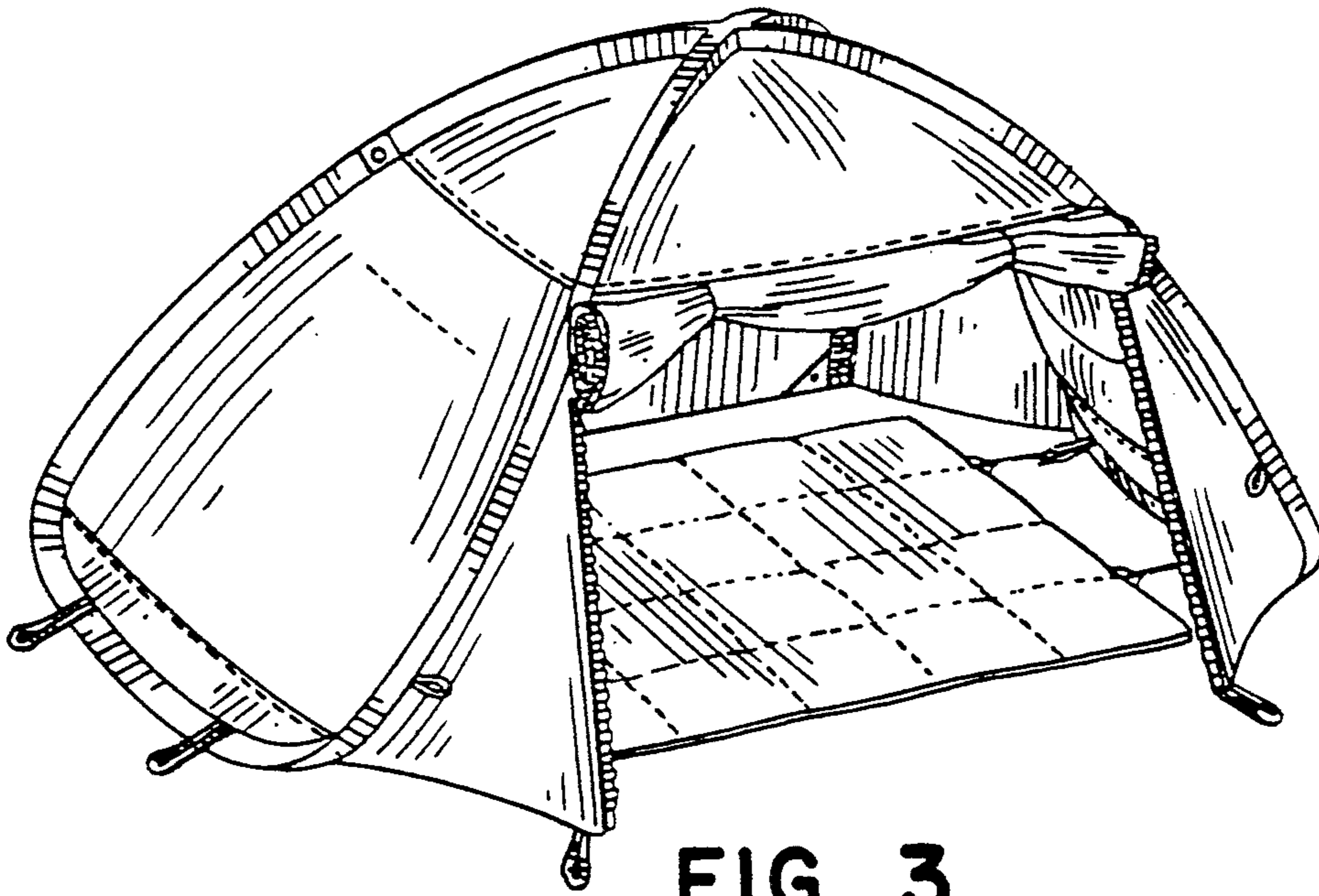

FIG. 3

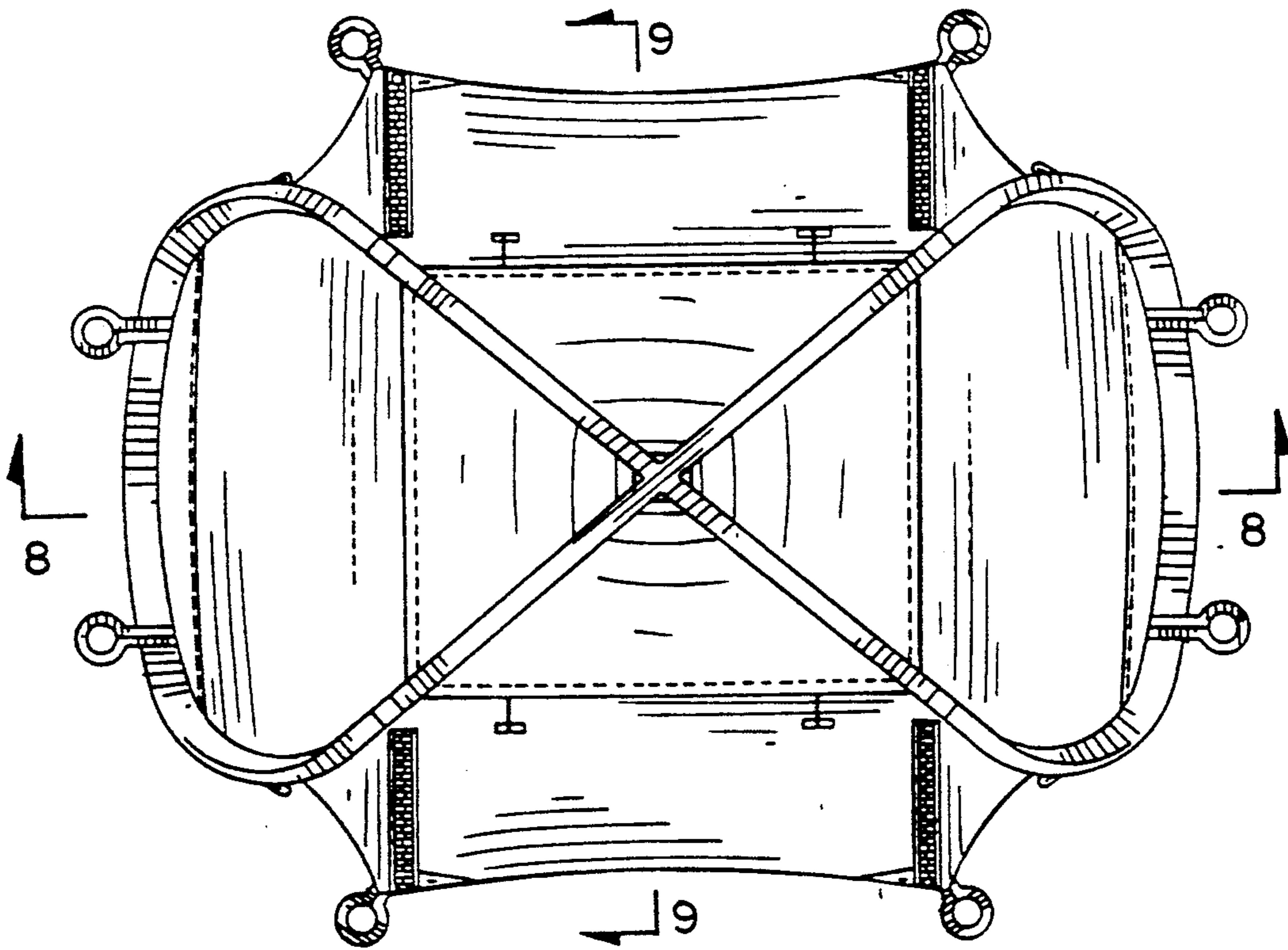
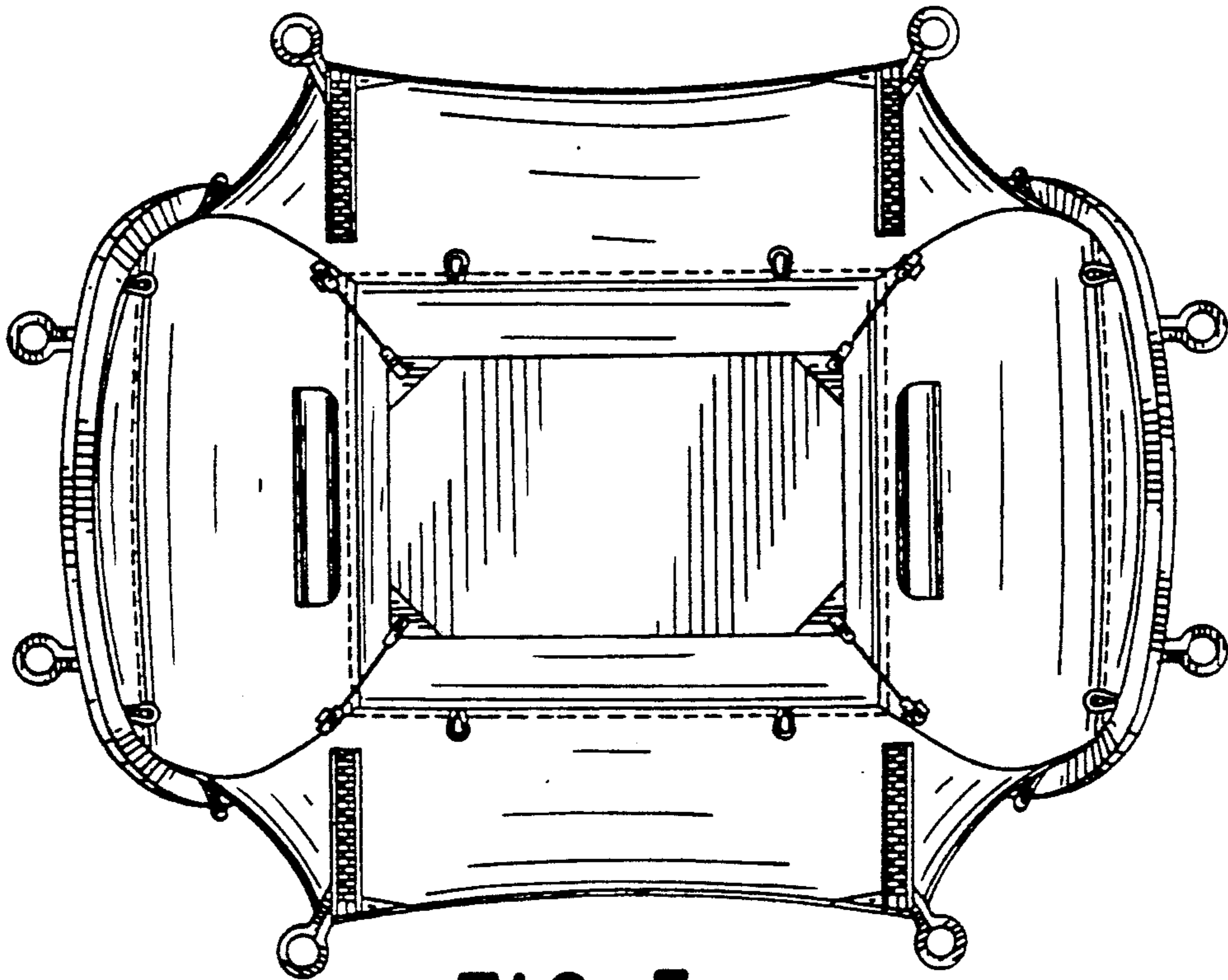
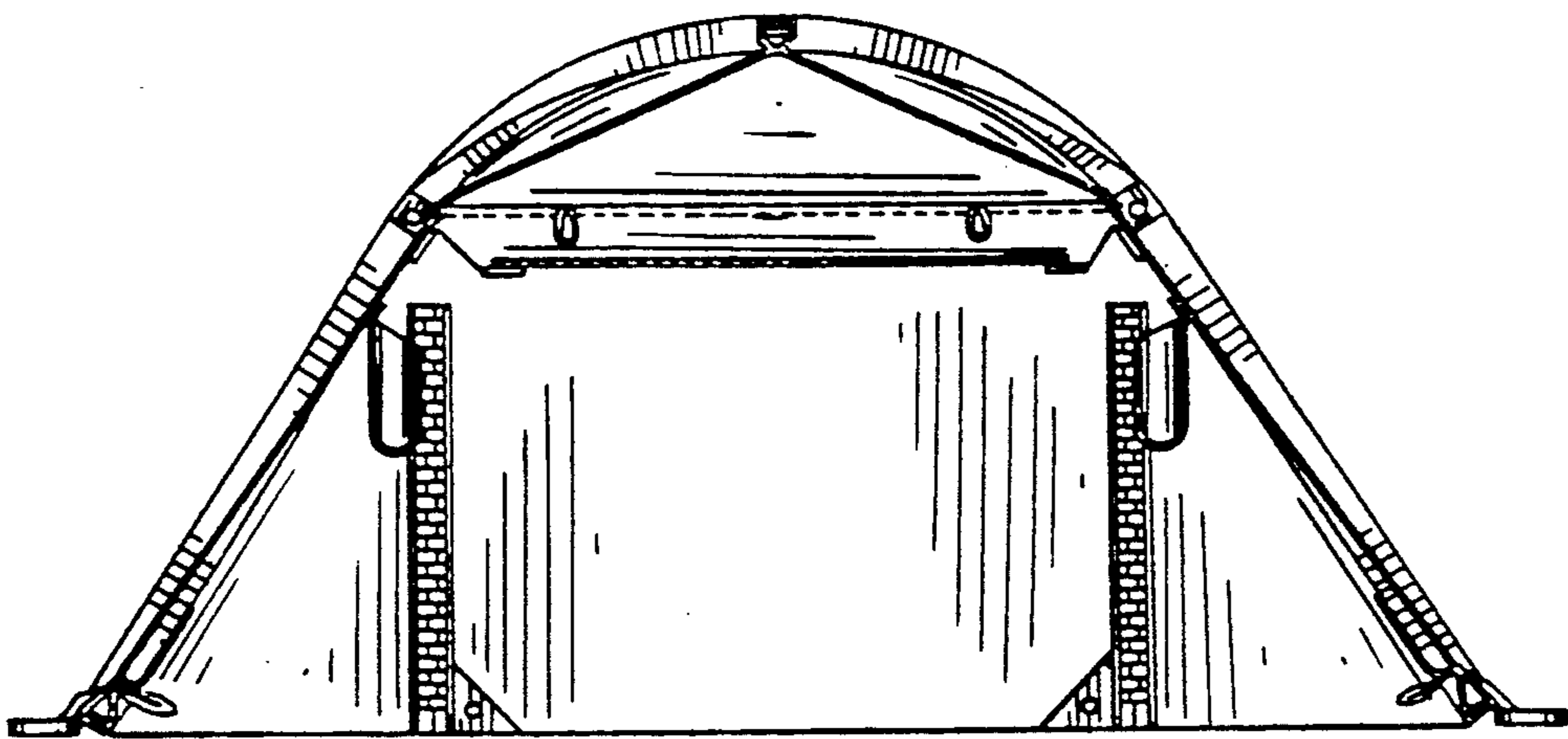

FIG. 4



**FIG. 5**



**FIG. 6**

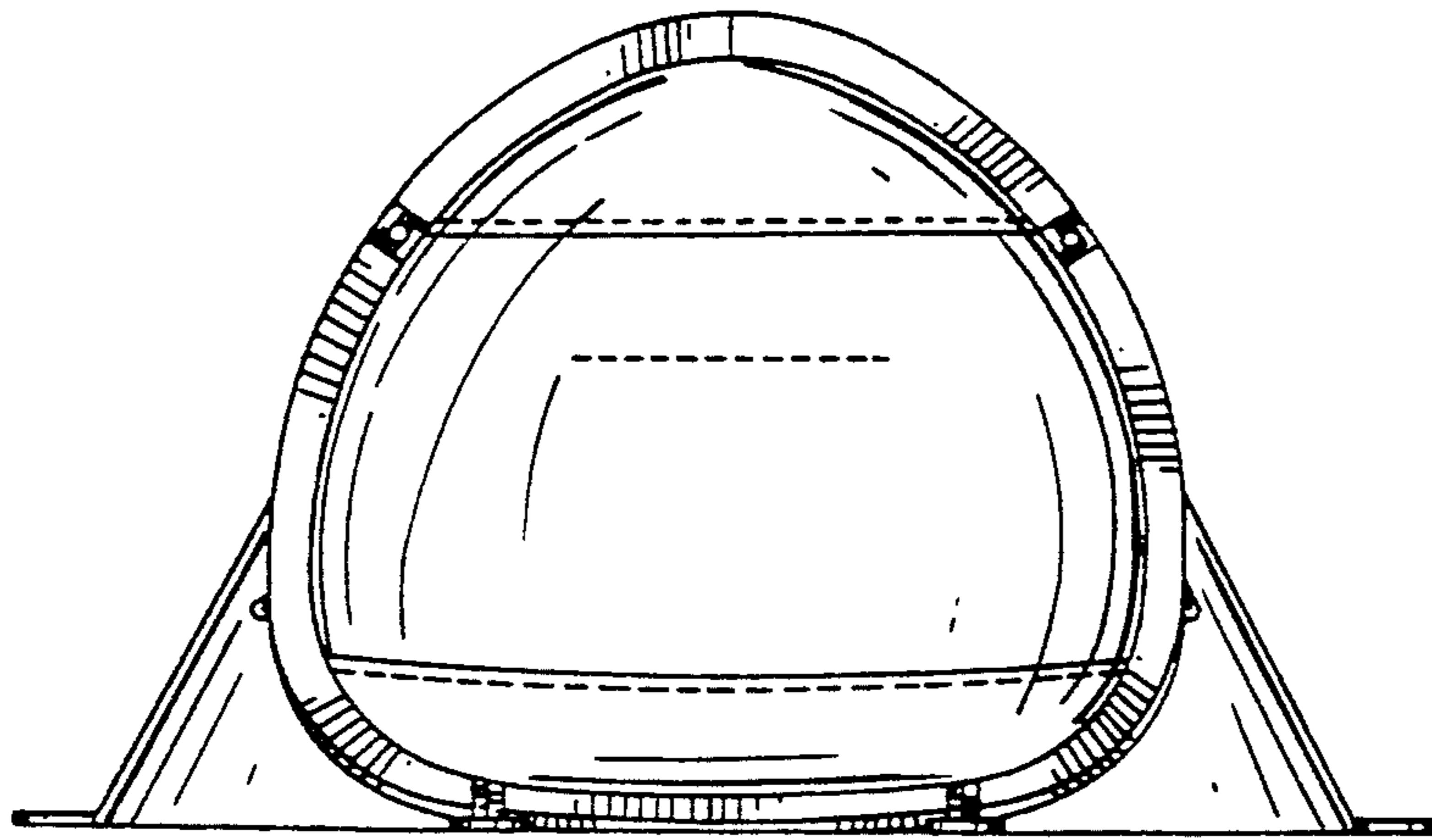

FIG. 7

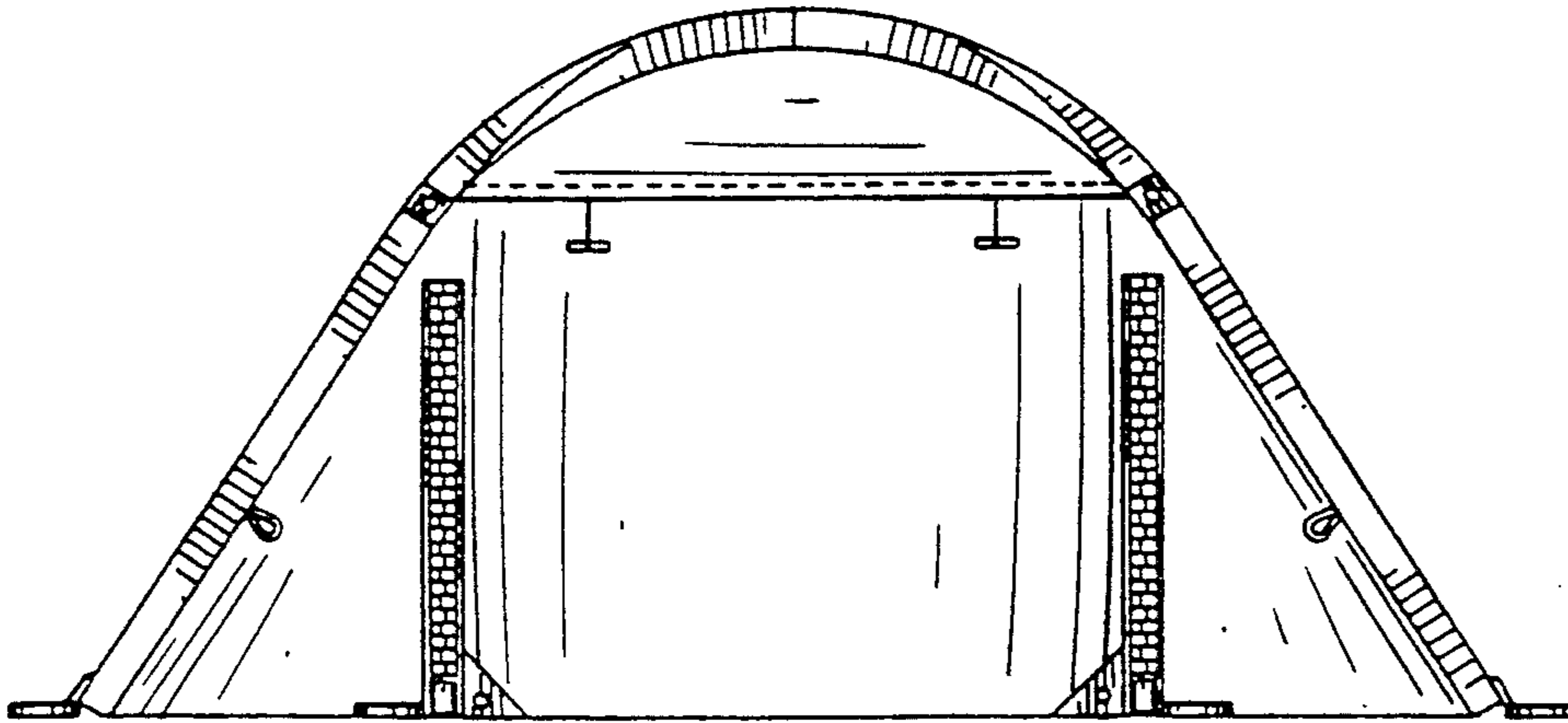

FIG. 8

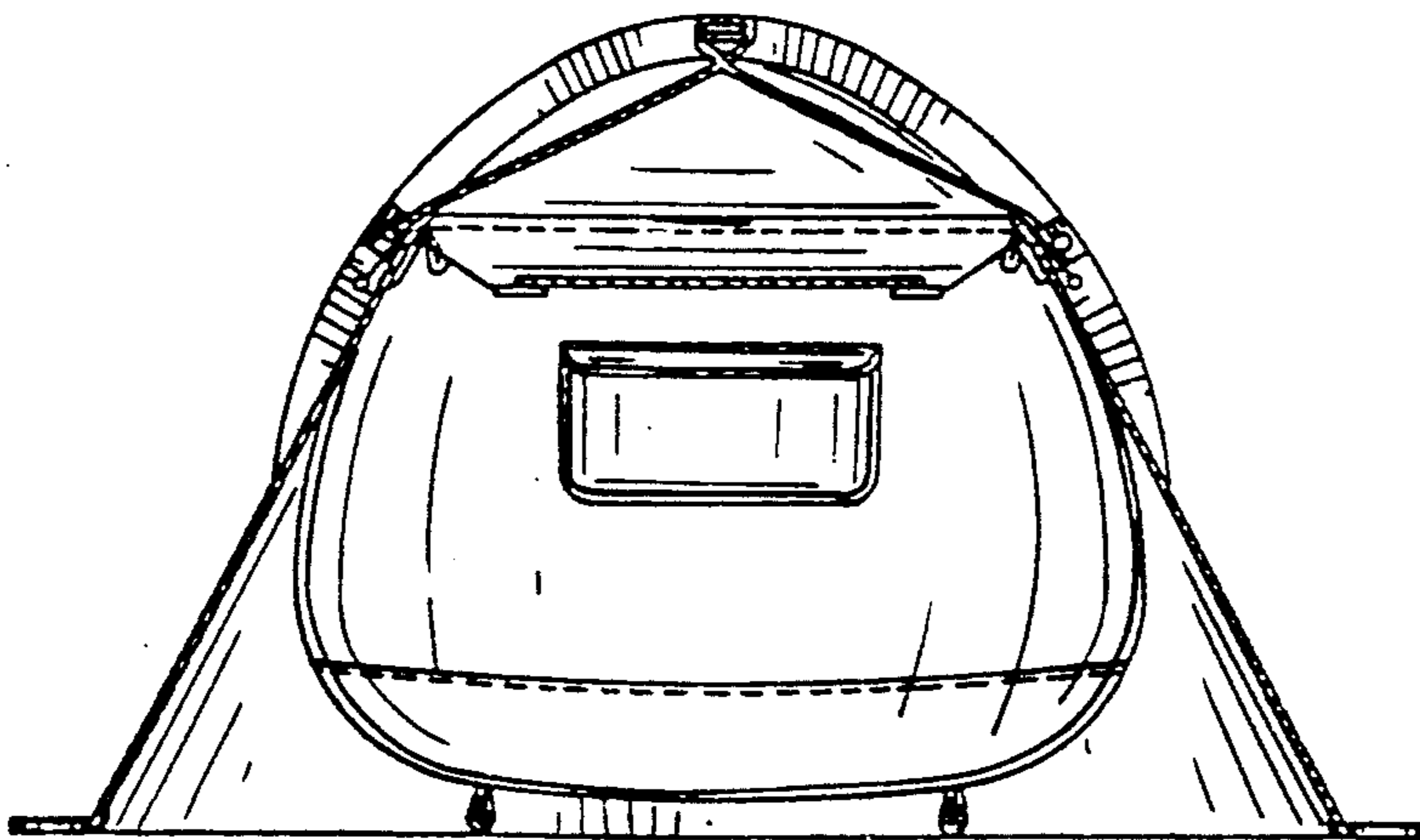

FIG. 9