



US00D327188S

United States Patent [19]

[11] Patent Number: **Des. 327,188**

Allen

[45] Date of Patent: **** Jun. 23, 1992**

[54] DISPLAY STAND FOR RETAIL MERCHANDISE

- [75] Inventor: John L. Allen, Houston, Tex.
- [73] Assignee: Liz Claiborne, Inc., New York, N.Y.
- [**] Term: 14 Years
- [21] Appl. No.: 410,742
- [22] Filed: Sep. 29, 1989
- [52] U.S. Cl. D6/474; D6/455
- [58] Field of Search D6/449, 474, 455, 457, D6/458-461, 466, 468, 475, 476; D20/10; 211/13, 163; 248/174, 346

OTHER PUBLICATIONS

Darling Displays, p. 52, Mirrored Counter Units. Modern Plastics Corp.

Primary Examiner—Donald P. Walsh
Assistant Examiner—Jeffrey Asch
Attorney, Agent, or Firm—Kirschstein, Ottinger, Israel & Schiffmiller

[56] References Cited

U.S. PATENT DOCUMENTS

D. 108,034	1/1938	Reinecke	D20/10
D. 108,418	2/1938	Bloomfield	D6/474
D. 122,047	8/1940	Watson	D6/474
D. 300,489	4/1989	Antonellis	D6/466
2,262,646	11/1941	Paige	D6/474 X
2,528,838	11/1950	Martino	D6/474 X

[57] CLAIM

The ornamental design for a display stand for retail merchandise, as shown.

DESCRIPTION

FIG. 1 is a top plan view of a display stand for retail merchandise showing my new design; FIG. 2 is a front elevational view thereof; FIG. 3 is a right side elevational view thereof; FIG. 4 is a left side elevational view thereof; FIG. 5 is a rear elevational view thereof; FIG. 6 is a bottom plan view thereof; and, FIG. 7 is an enlarged perspective view thereof.

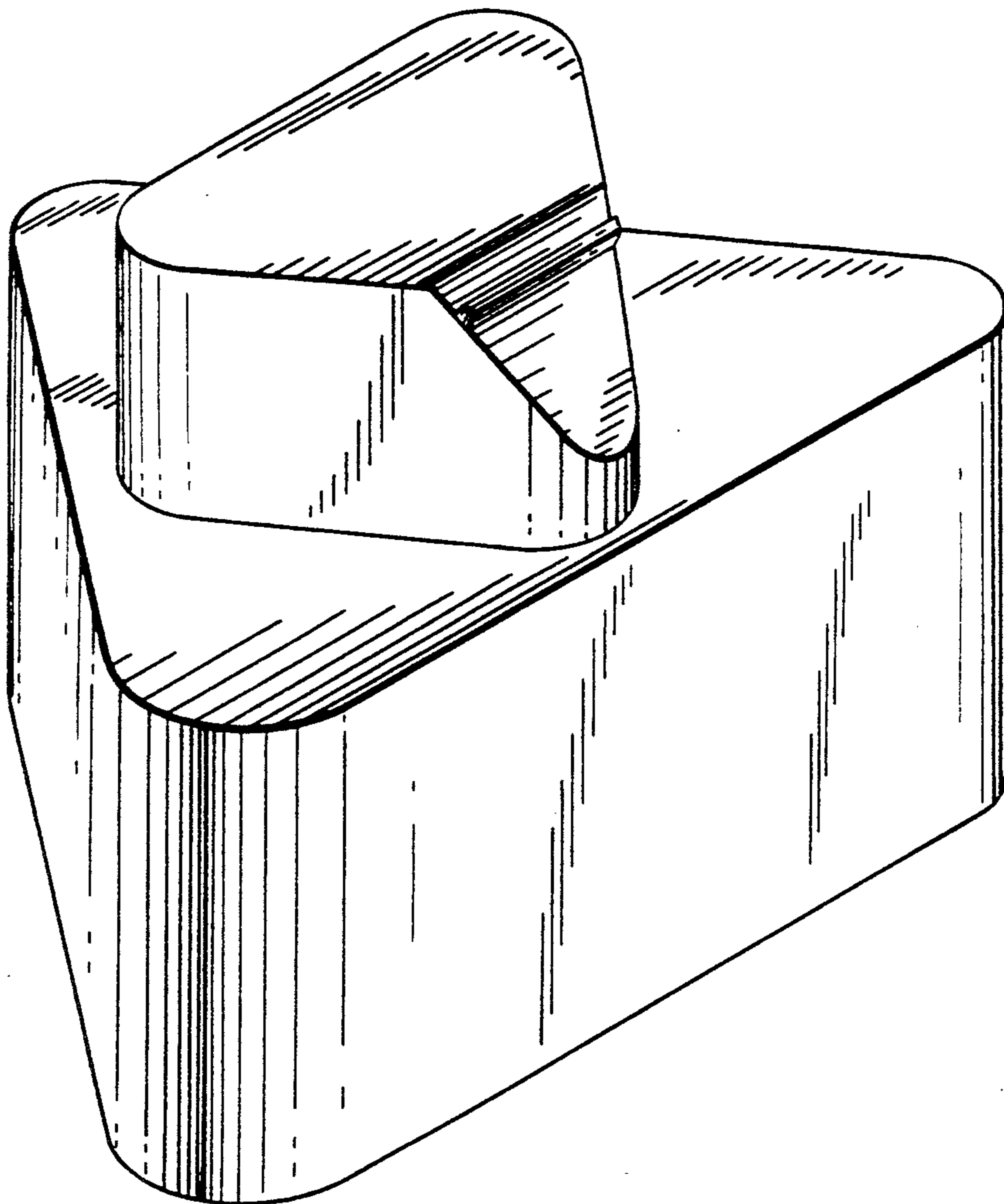

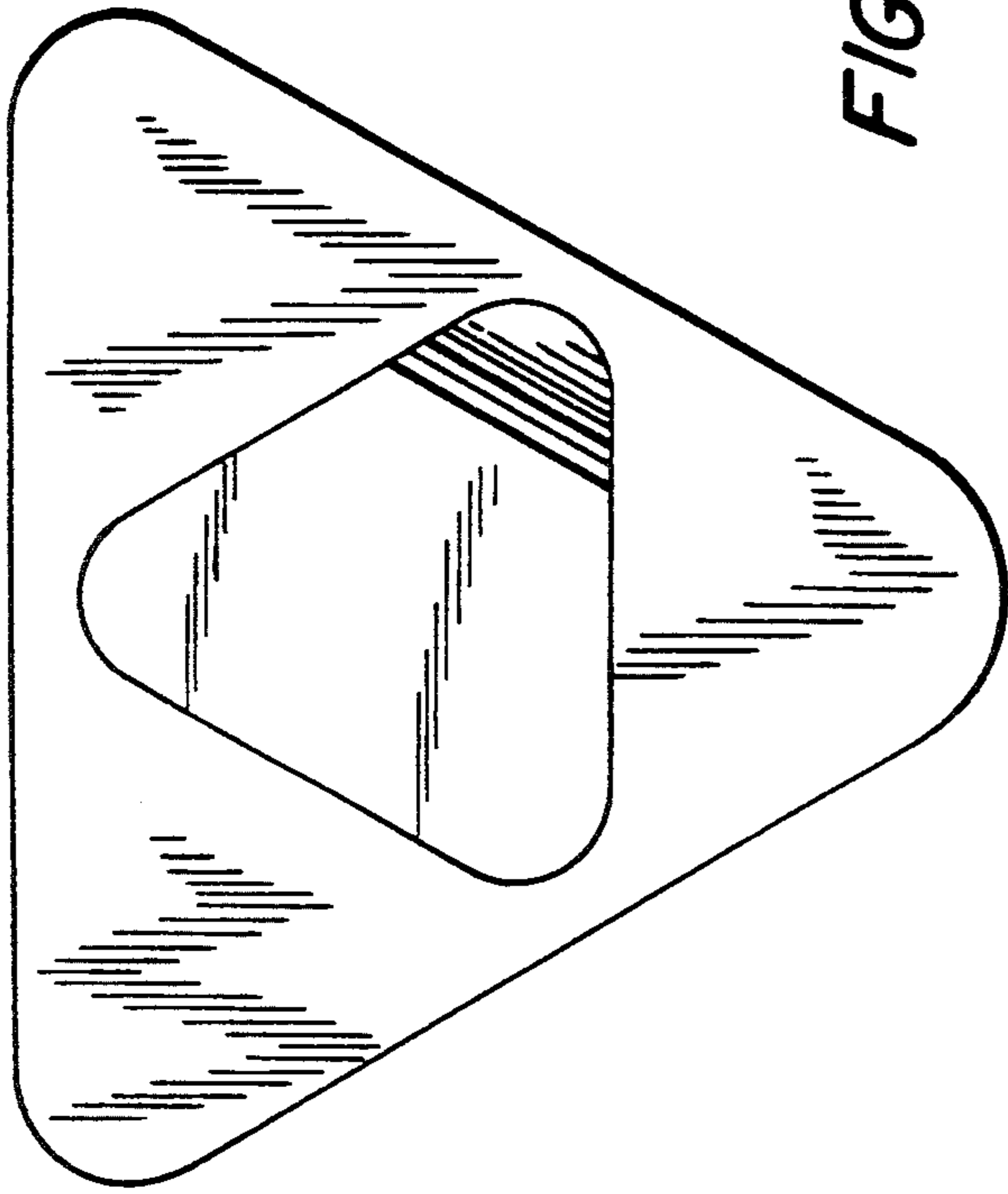

FIG. 1

FIG. 3

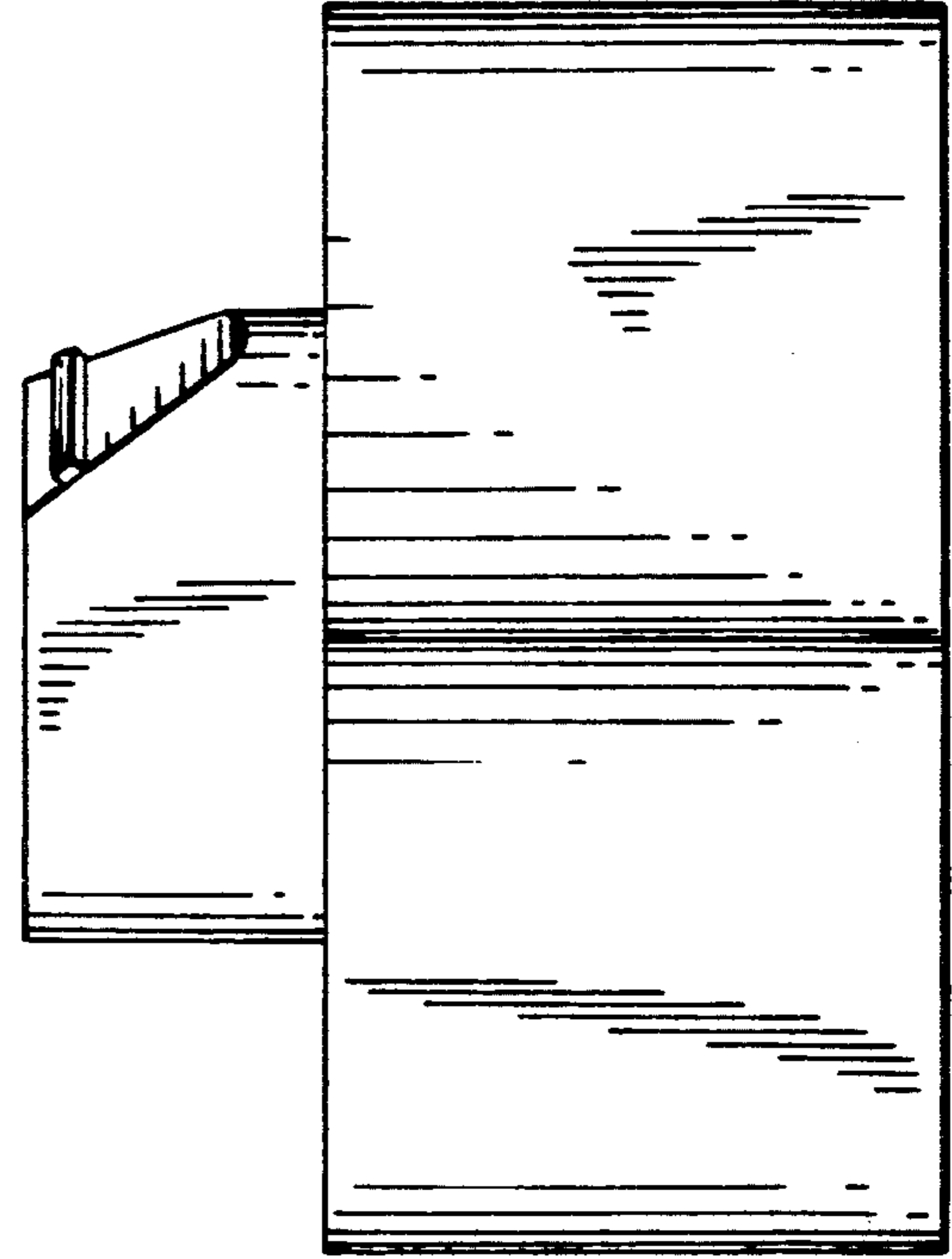
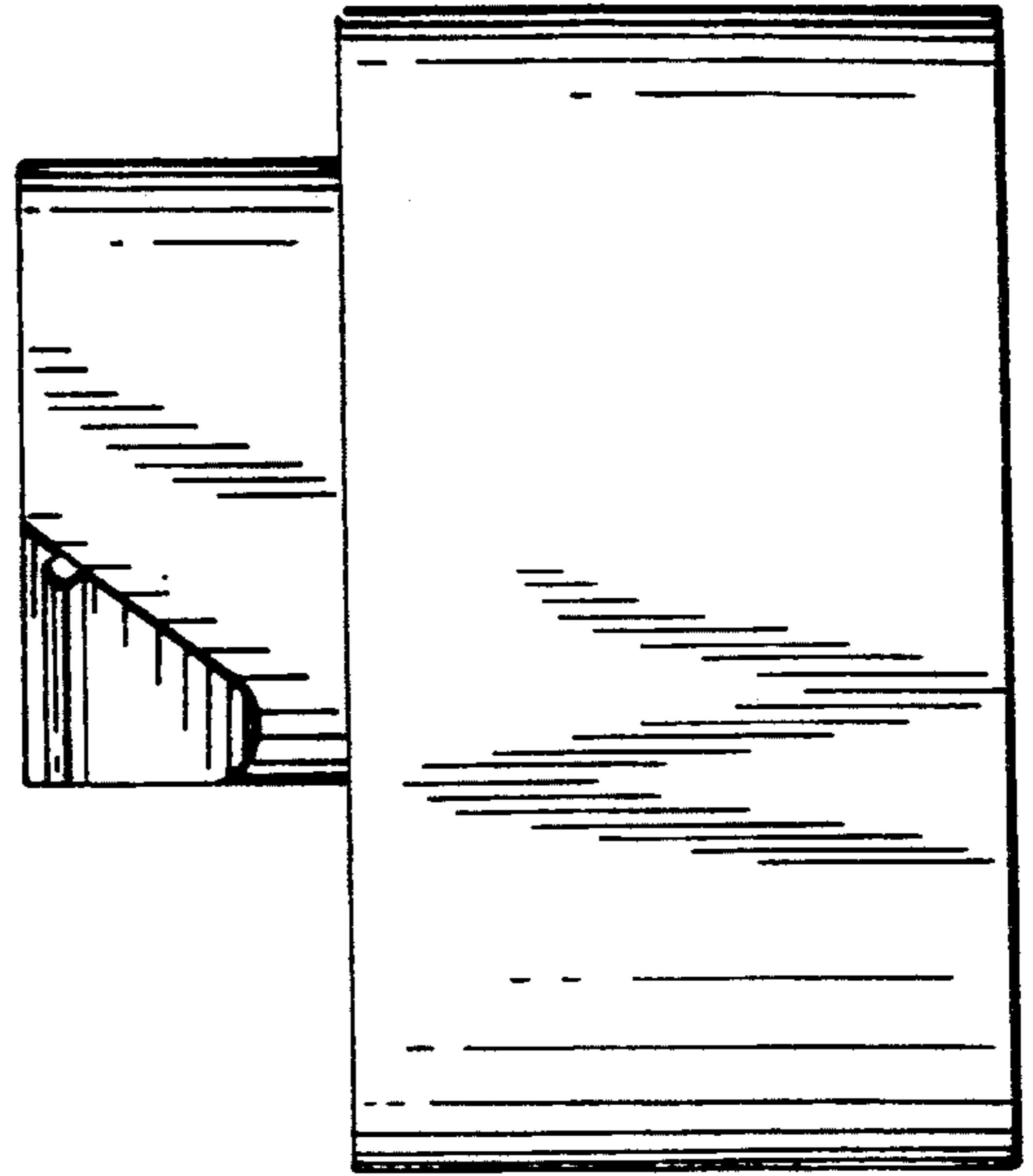

FIG. 2

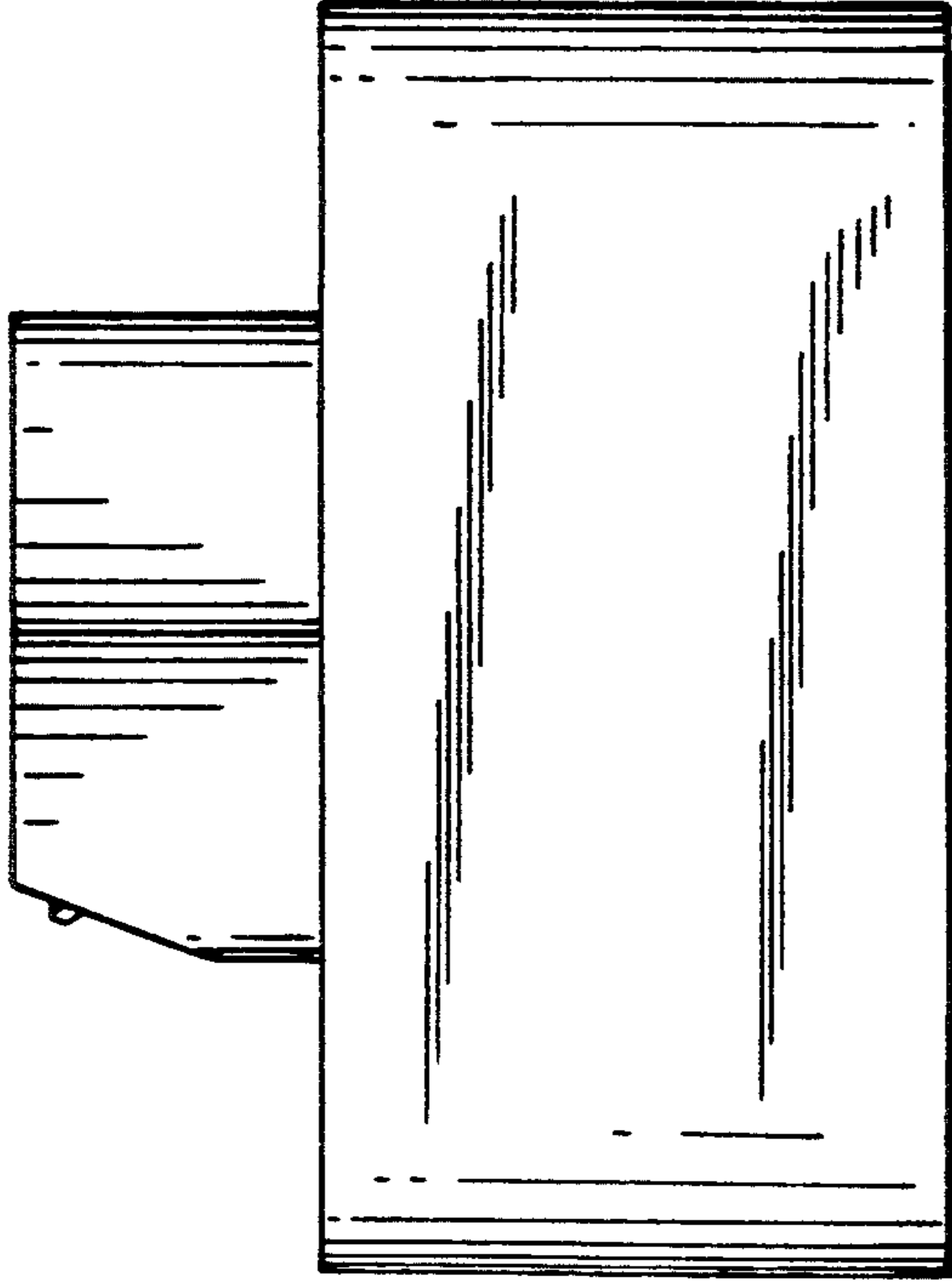

FIG. 4

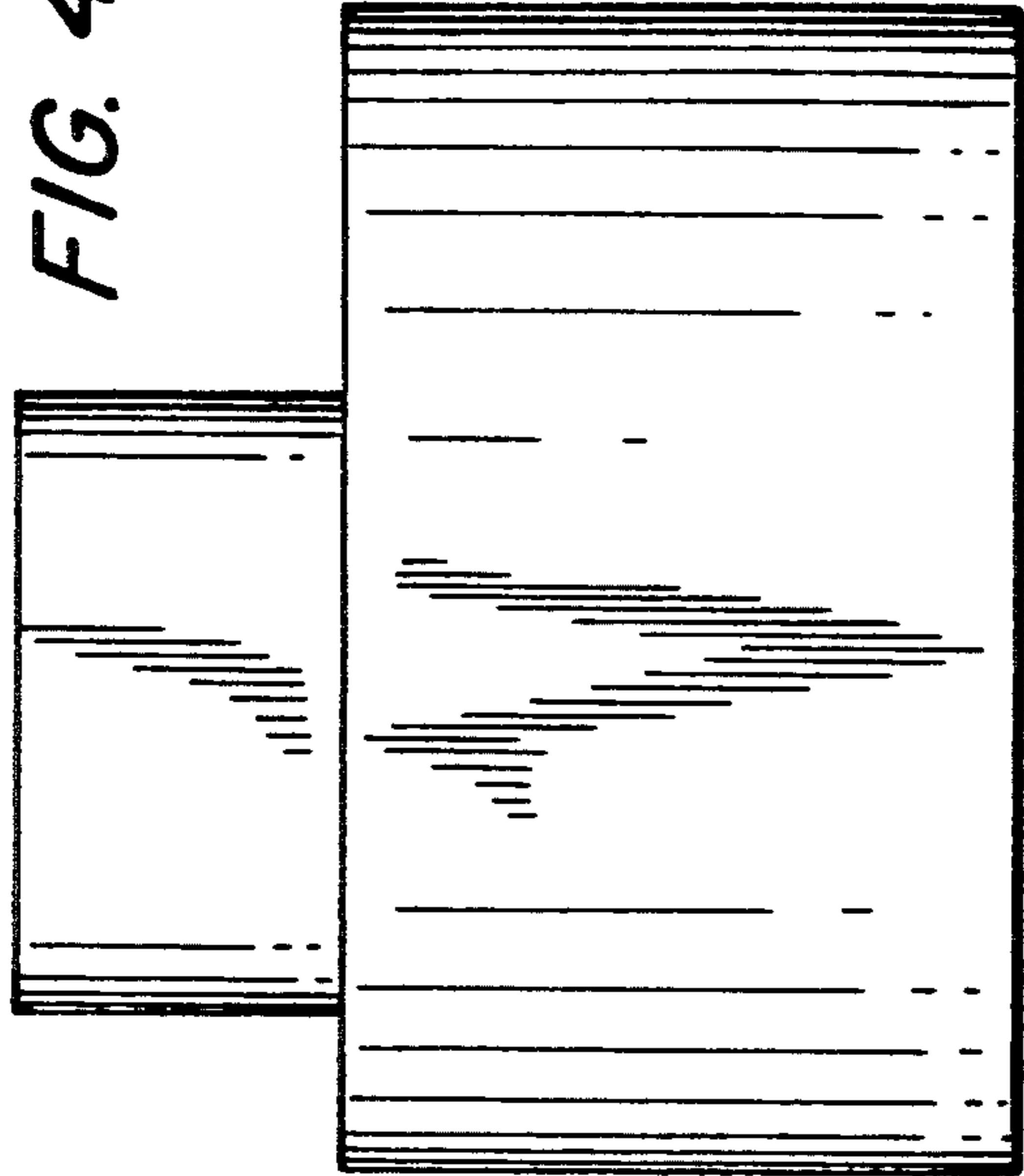

FIG. 5

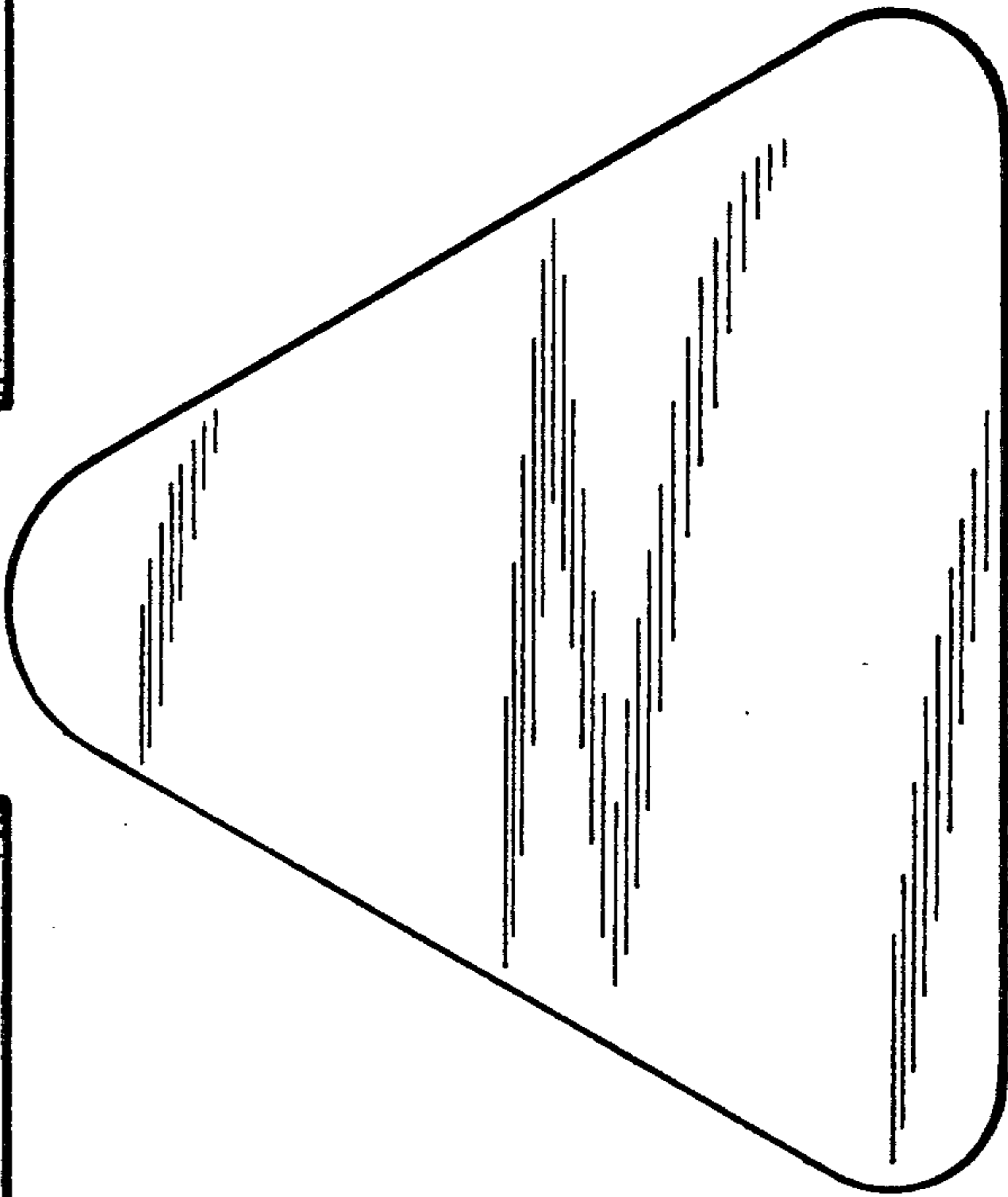

FIG. 6

FIG. 7

