



US00D327131S

United States Patent [19]

[11] Patent Number: **Des. 327,131**

Vrancart et al.

[45] Date of Patent: **** Jun. 16, 1992**

[54] **REFLECTOR LAMP**

4,939,420 7/1990 Lim 313/318 X

[75] Inventors: **Albert J. Vrancart**, East Brunswick;
Dennis J. Priscandaro, Forked River,
both of N.J.

Primary Examiner—Susan J. Lucas
Attorney, Agent, or Firm—Jack E. Haken

[73] Assignee: **North American Philips Corporation**,
New York, N.Y.

[57] **CLAIM**

The ornamental design for a reflector lamp, as shown
and described.

[**] Term: **14 Years**

DESCRIPTION

[21] Appl. No.: **459,103**

FIG. 1 is a front elevational view of a reflector lamp
showing our new design;

[22] Filed: **Dec. 28, 1989**

FIG. 2 is a top plan view thereof, the bottom being a
mirror image;

[52] U.S. Cl. **D26/2**

FIG. 3 is a rear elevational view thereof;

[58] Field of Search **D26/2, 26, 3; 362/326,
362/334, 335, 337, 351, 355; 313/493, 113, 315,
318**

FIG. 4 is a side elevational view thereof, the opposite
side being a mirror image;

[56] **References Cited**

U.S. PATENT DOCUMENTS

D. 306,765	3/1990	Pavelin	D26/2
D. 309,503	7/1990	Benson et al.	D26/2
1,042,412	10/1912	Dorey	362/340
3,413,508	11/1968	Pitkjaan .	
4,300,189	11/1981	Shanks .	
4,569,867	2/1986	Noe .	
4,572,730	2/1986	Noe .	

FIG. 5 is a front perspective view thereof; and,

FIG. 6 is a front perspective view of a second embodi-
ment of our new design.

The second embodiment differs from the first only in
that the front of the reflector is open, whereas the front
of the reflector is closed in the first embodiment by a
glass cover. The base of the lamp is shown in broken
lines in both embodiments for illustrative purposes only
and forms no part of the claimed design.

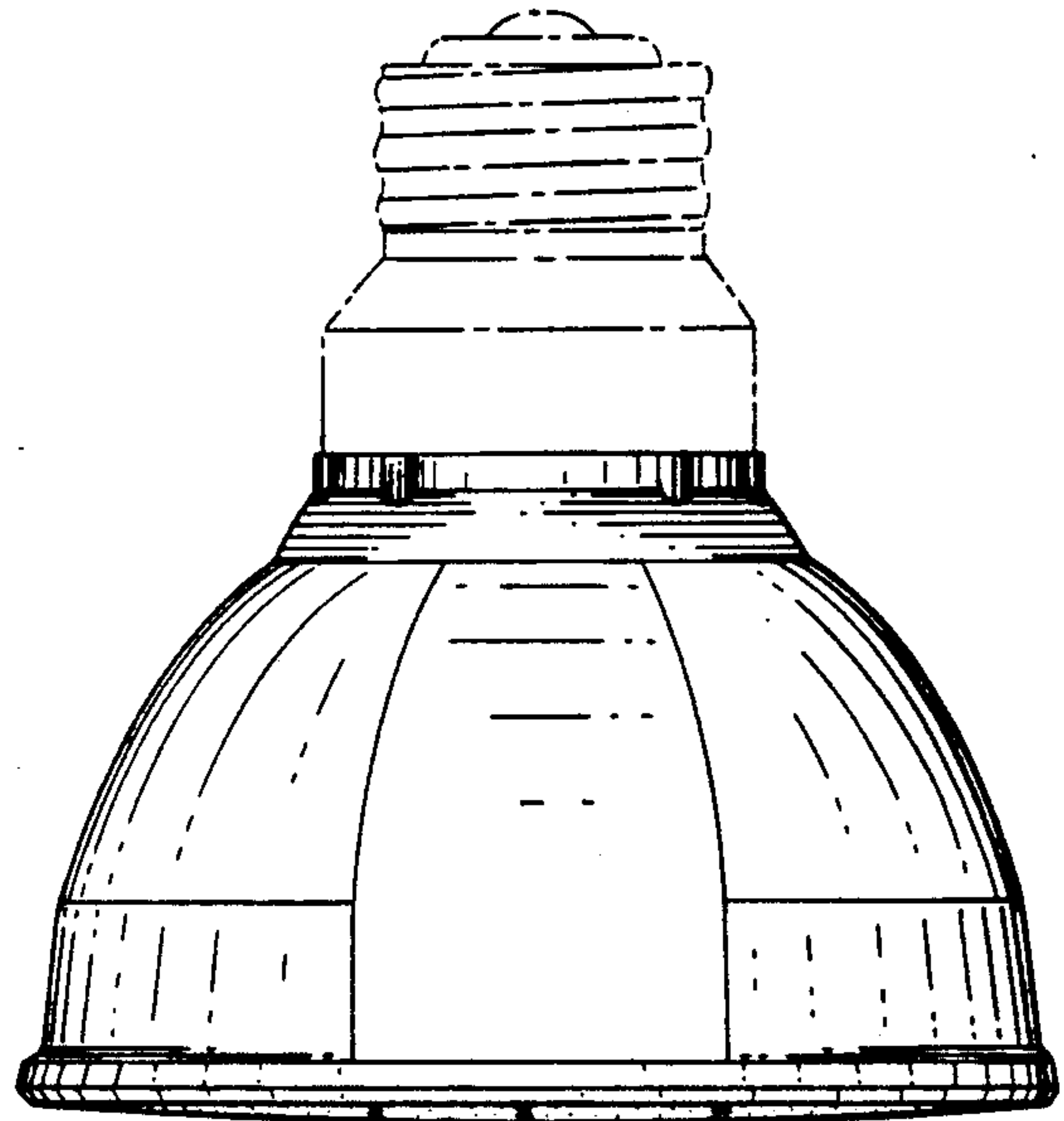
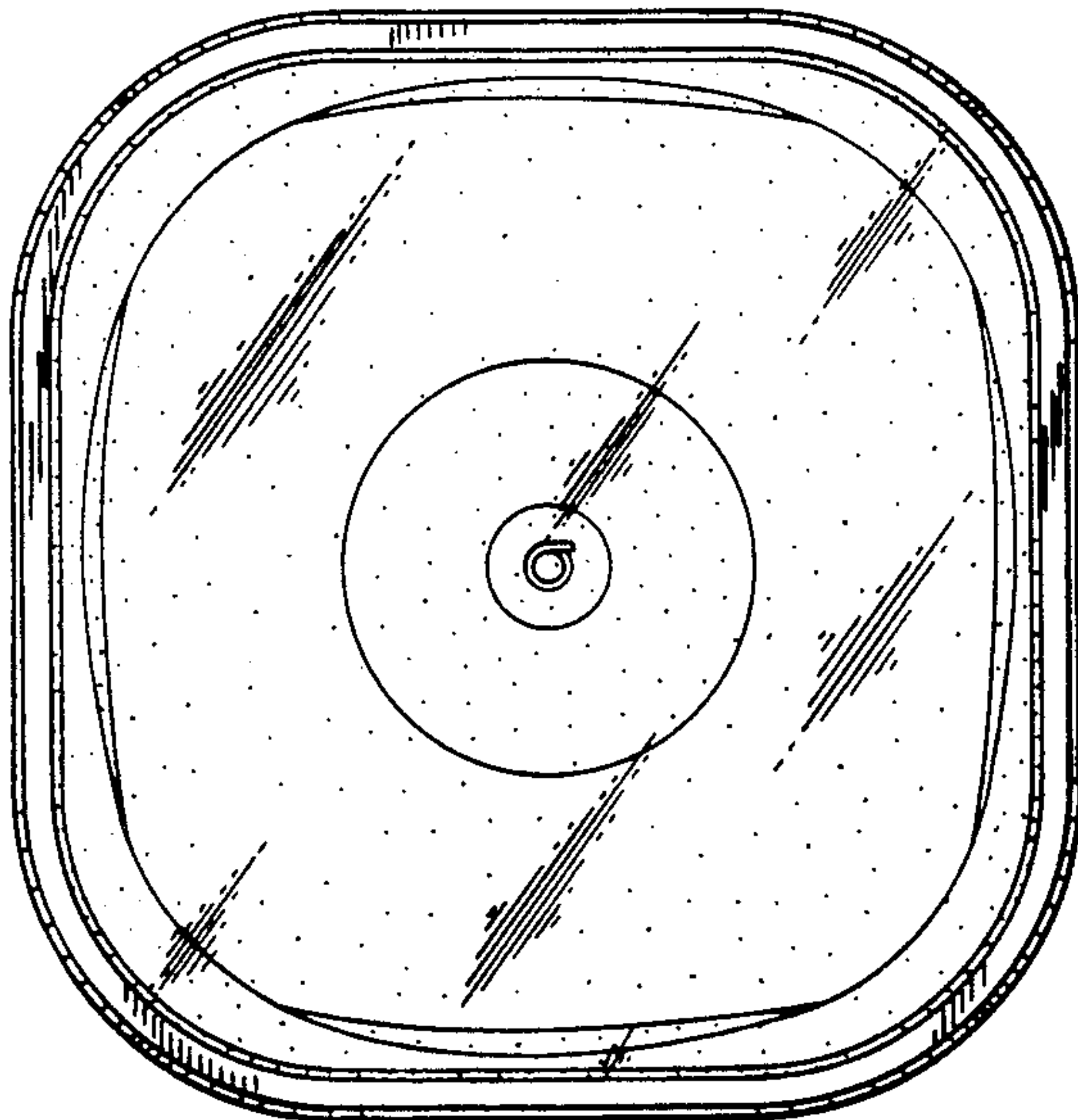

FIG. 1

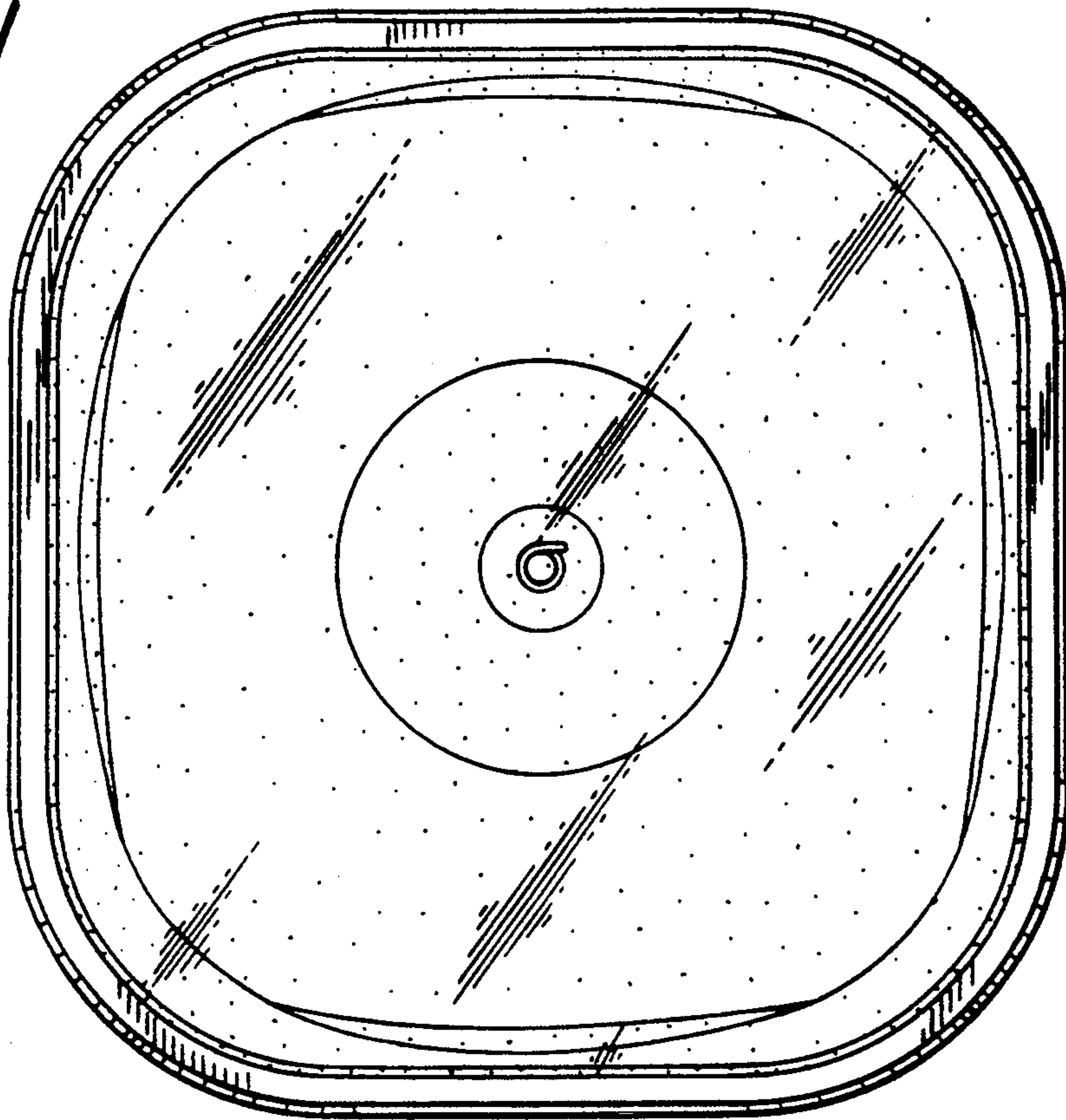

FIG. 2

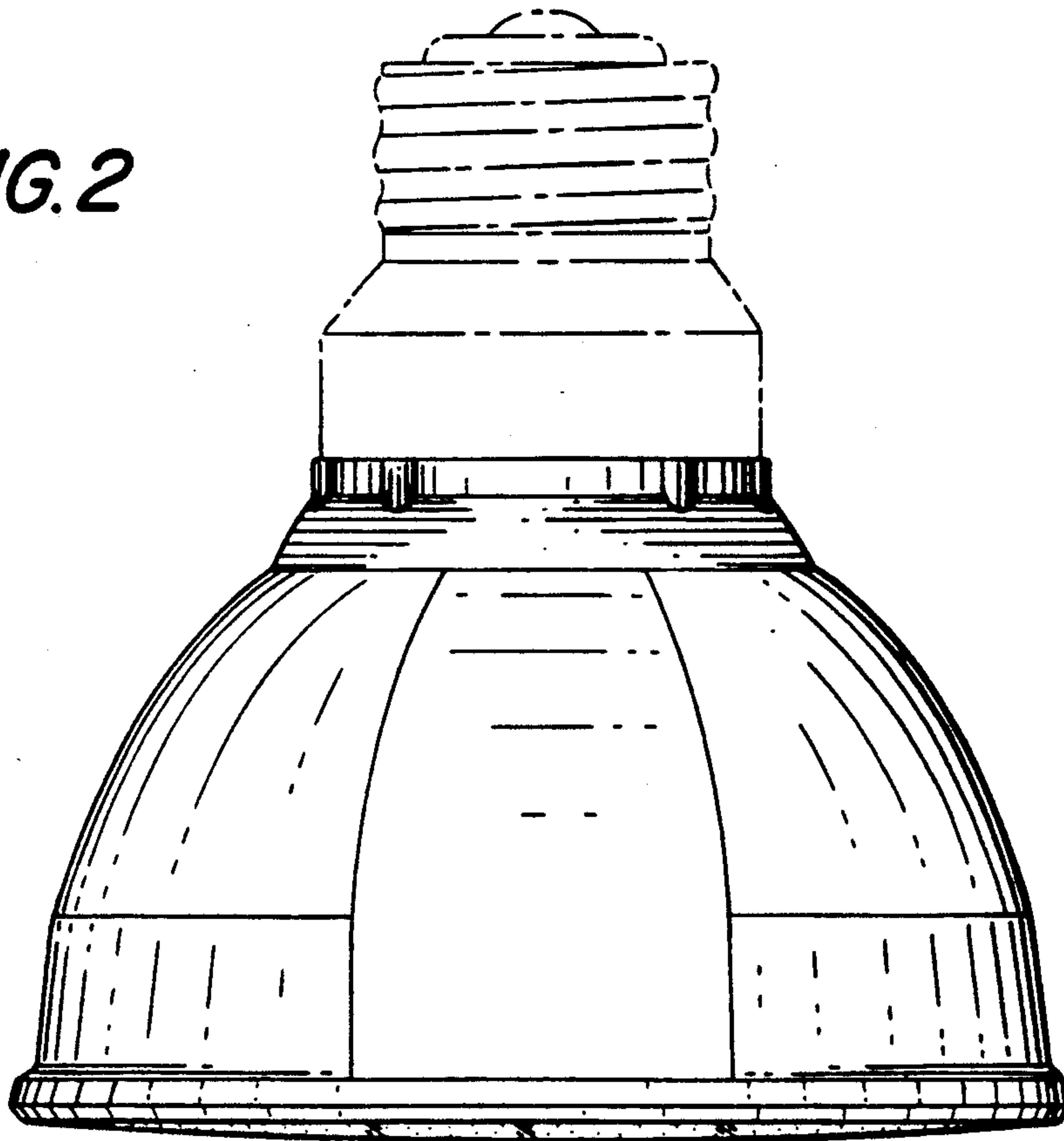

FIG. 3

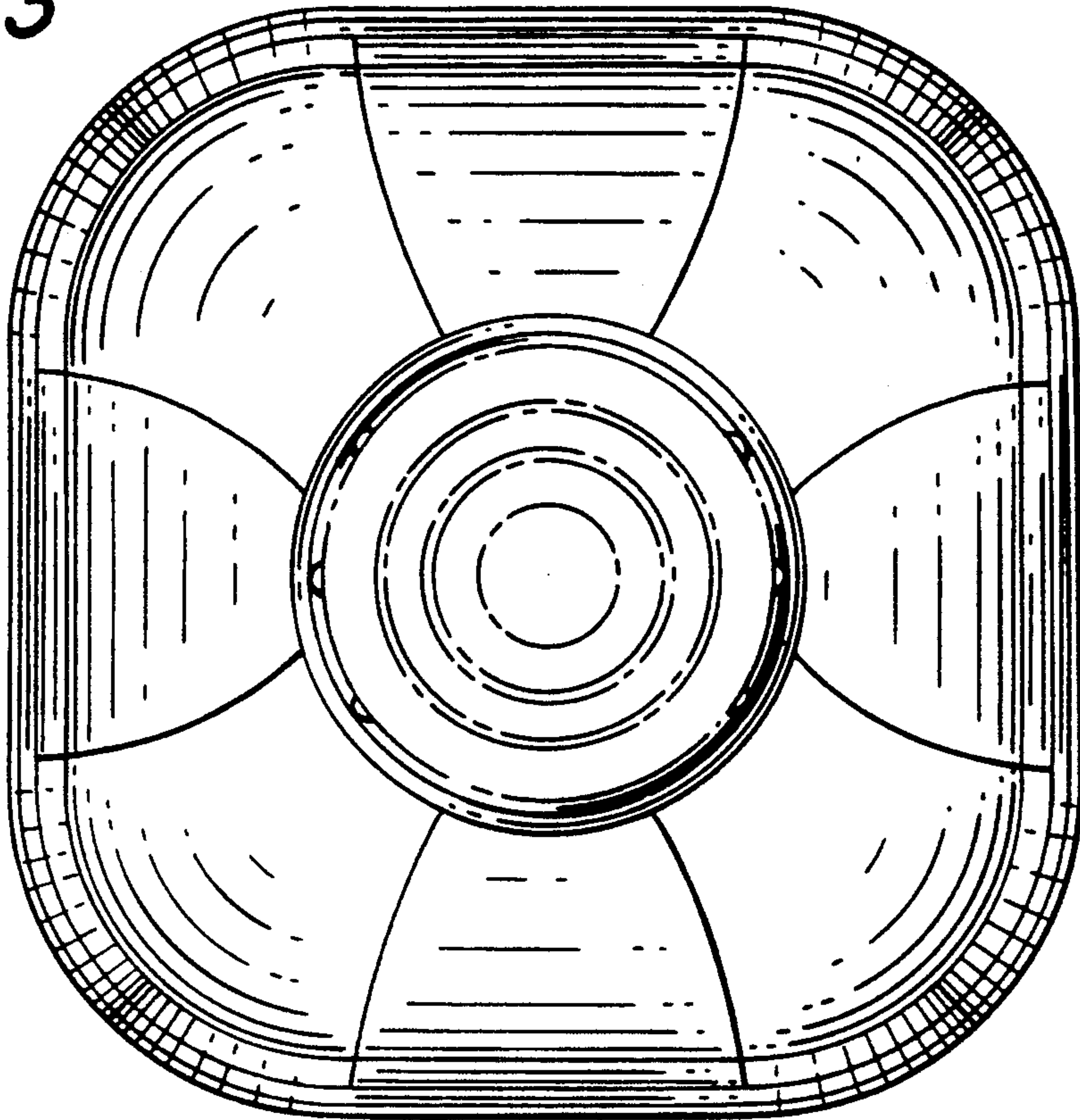

FIG. 4

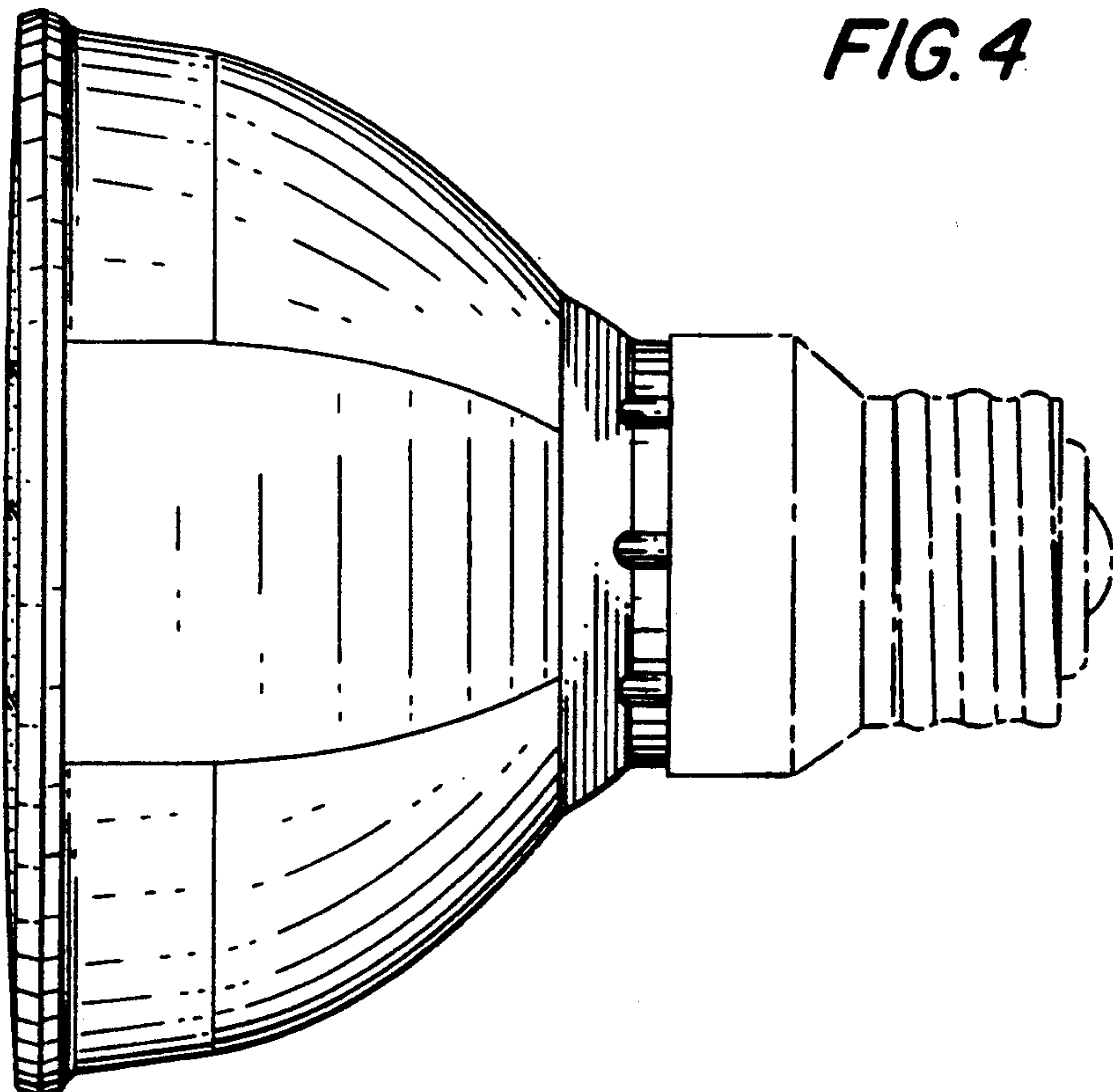

FIG. 5

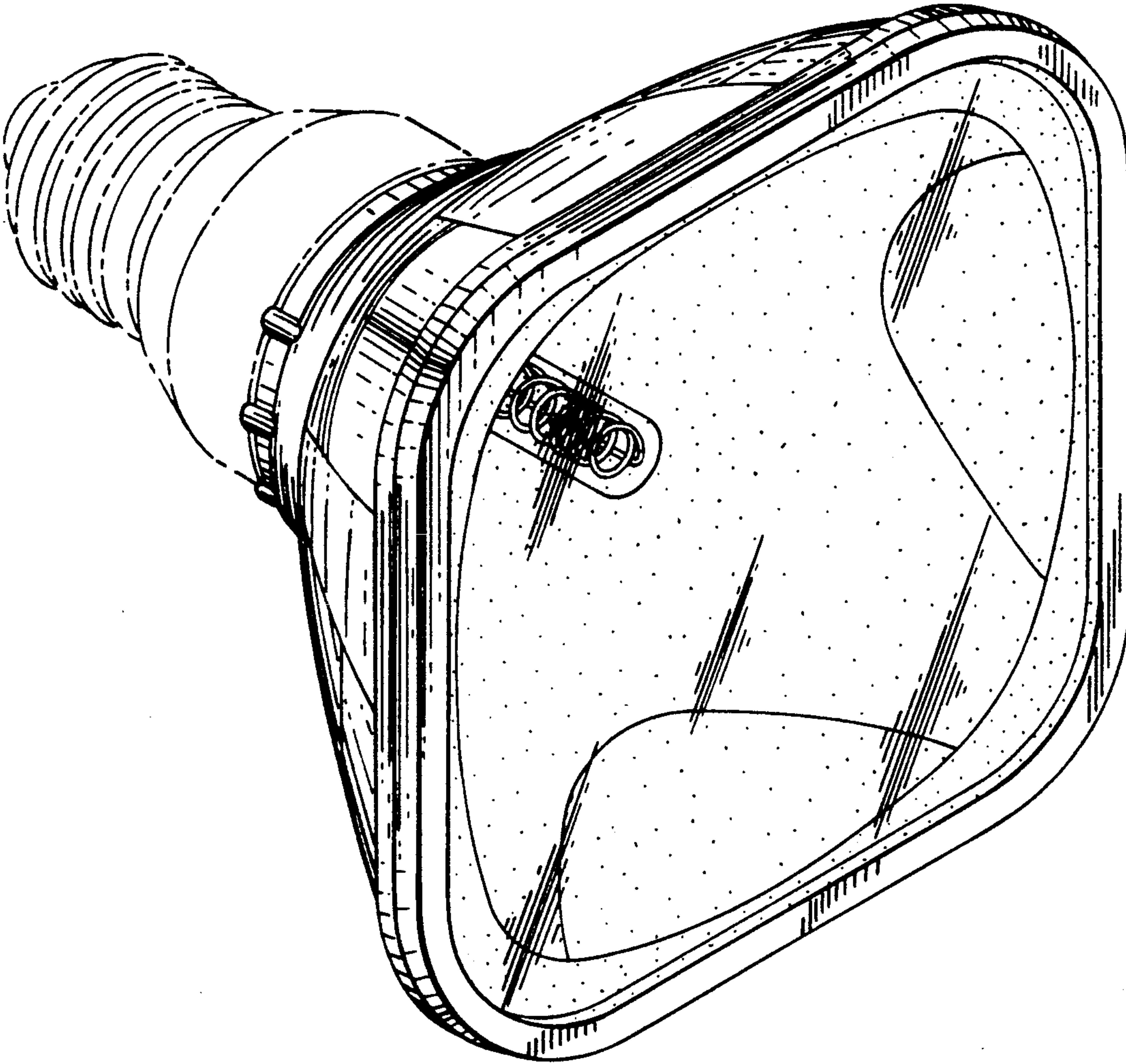

FIG. 6

