



US00D327064S

United States Patent [19]

[11] Patent Number: Des. 327,064

Ditzig et al.

[45] Date of Patent: ** Jun. 16, 1992

[54] TELEPHONE HANDSET

DESCRIPTION

[75] Inventors: Albert Ditzig, Hoffman Estates;
Jerome L. Oldani, Aurora, both of Ill.

[73] Assignee: Goeken Group Corporation, Oak Brook Terrace, Ill.

[**] Term: 14 Years

[21] Appl. No.: 519,686

[22] Filed: May 8, 1990

[52] U.S. Cl. D14/148; D14/248;
D14/140; D14/142

[58] Field of Search D14/147, 148, 248;
379/433, 428, 440; D21/111

FIG. 1 is a front, bottom and side perspective view of a telephone handset, showing our new design;
FIG. 2 is a front elevational view thereof;
FIG. 3 is a right side elevational view thereof;
FIG. 4 is a left side elevational view thereof;
FIG. 5 is a top plan view thereof;
FIG. 6 is a bottom plan view thereof;
FIG. 7 is a rear elevational view thereof;
FIG. 8 is a front elevational view of a second embodiment of our new design;
FIG. 9 is a right side elevational view thereof;
FIG. 10 is a left side elevational view thereof;
FIG. 11 is a top plan view thereof;
FIG. 12 is a bottom plan view thereof;
FIG. 13 is rear elevational view thereof;
FIG. 14 is a front, bottom and side perspective view of a third embodiment of our new design;
FIG. 15 is a front elevational view thereof;
FIG. 16 is a right side elevational view thereof;
FIG. 17 is a left side elevational view thereof;
FIG. 18 is a top plan view thereof;
FIG. 19 is a bottom plan view thereof;
FIG. 20 is a rear elevational view thereof;
FIG. 21 is a front, bottom and side perspective view of a fourth embodiment of our new design;
FIG. 22 is a front elevational view thereof;
FIG. 23 is a right side elevational view thereof;
FIG. 24 is a left side elevational view thereof;
FIG. 25 is a top plan view thereof;
FIG. 26 is a bottom plan view thereof;
FIG. 27 is a rear elevational view thereof;
FIG. 28 is a front, bottom and side perspective view of a fifth embodiment of our new design;
FIG. 29 is a front elevational view thereof;
FIG. 30 is a right side elevational view thereof;
FIG. 31 is a left side elevational view thereof;
FIG. 32 is a top plan view thereof;
FIG. 33 is a bottom plan view thereof; and,
FIG. 34 is a rear elevational view thereof.

[56] References Cited

U.S. PATENT DOCUMENTS

D. 276,723	12/1984	Marshall	D14/147
D. 277,378	1/1985	Cooke et al.	D14/147
D. 279,672	7/1985	Baum	D14/147
D. 292,285	10/1987	Kando	D14/147
D. 295,627	5/1988	Wagele	D14/147
D. 300,825	4/1989	Pitkonen	D14/148 X
D. 303,382	9/1989	Yoshihara	D14/147 X
D. 309,302	7/1990	Dickson	D14/148 X
D. 316,857	5/1991	Park	D14/142 X
D. 320,799	10/1991	Holf	D14/248 X

OTHER PUBLICATIONS

B. A. Pargh, 1989 Catalog ©1989: pp. 343 to 349 showing numerous references of Handset Telephone, and Telephone Handsets.

Primary Examiner—Horace B. Fay, Jr.
Attorney, Agent, or Firm—Jeffrey M. Morris

[57] CLAIM

The ornamental design for a telephone handset, as shown and described.

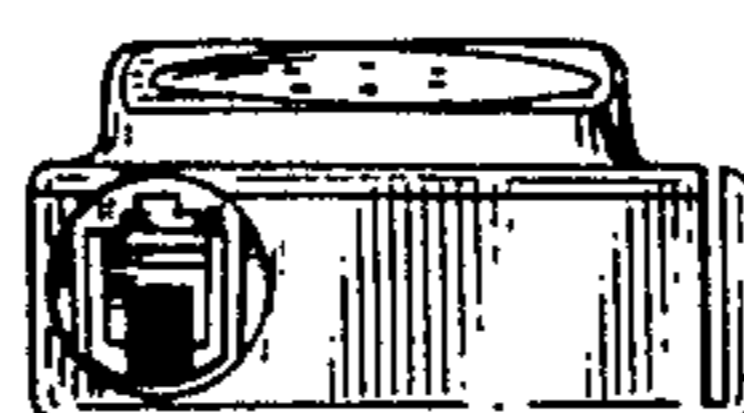
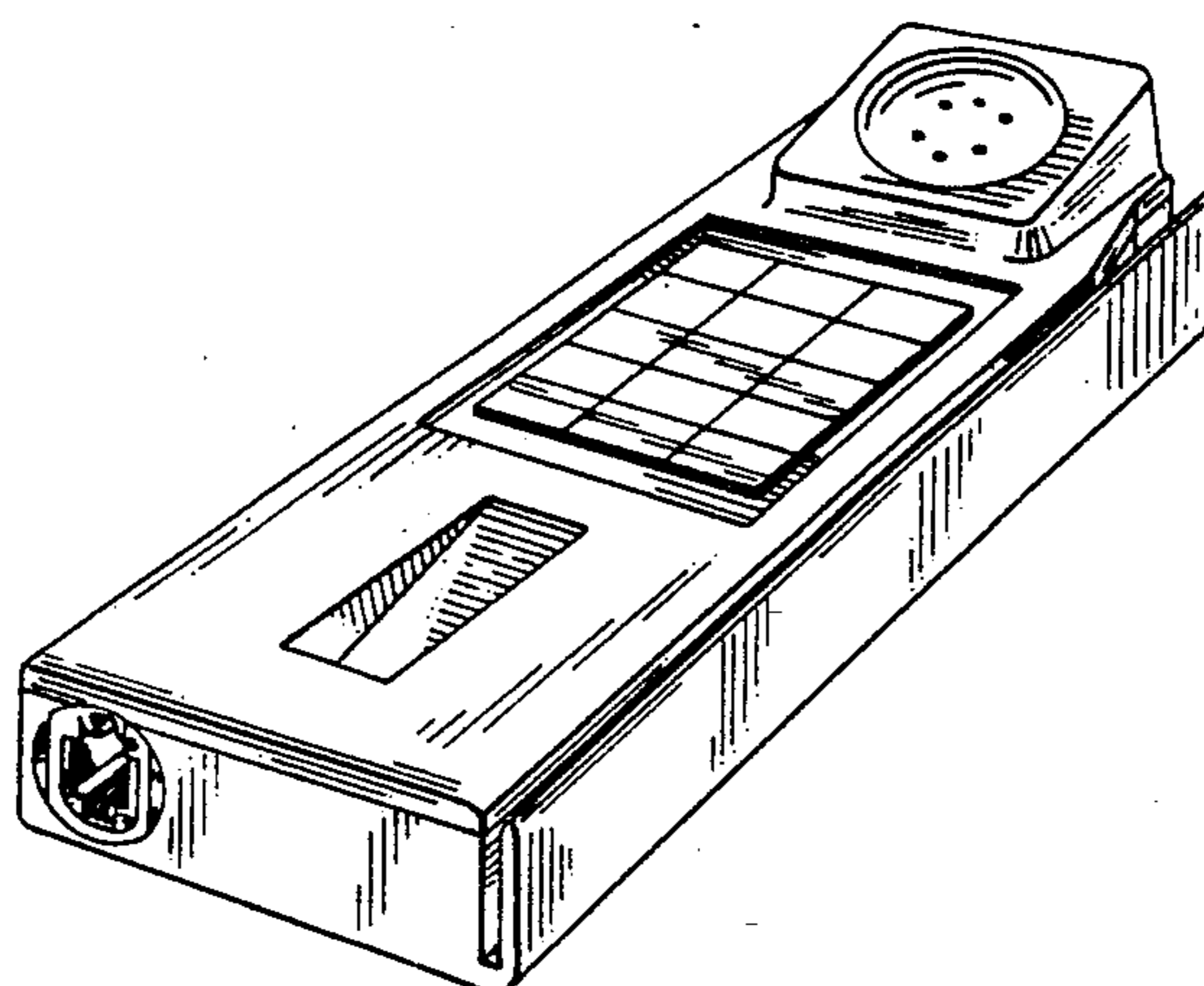

FIG. 1

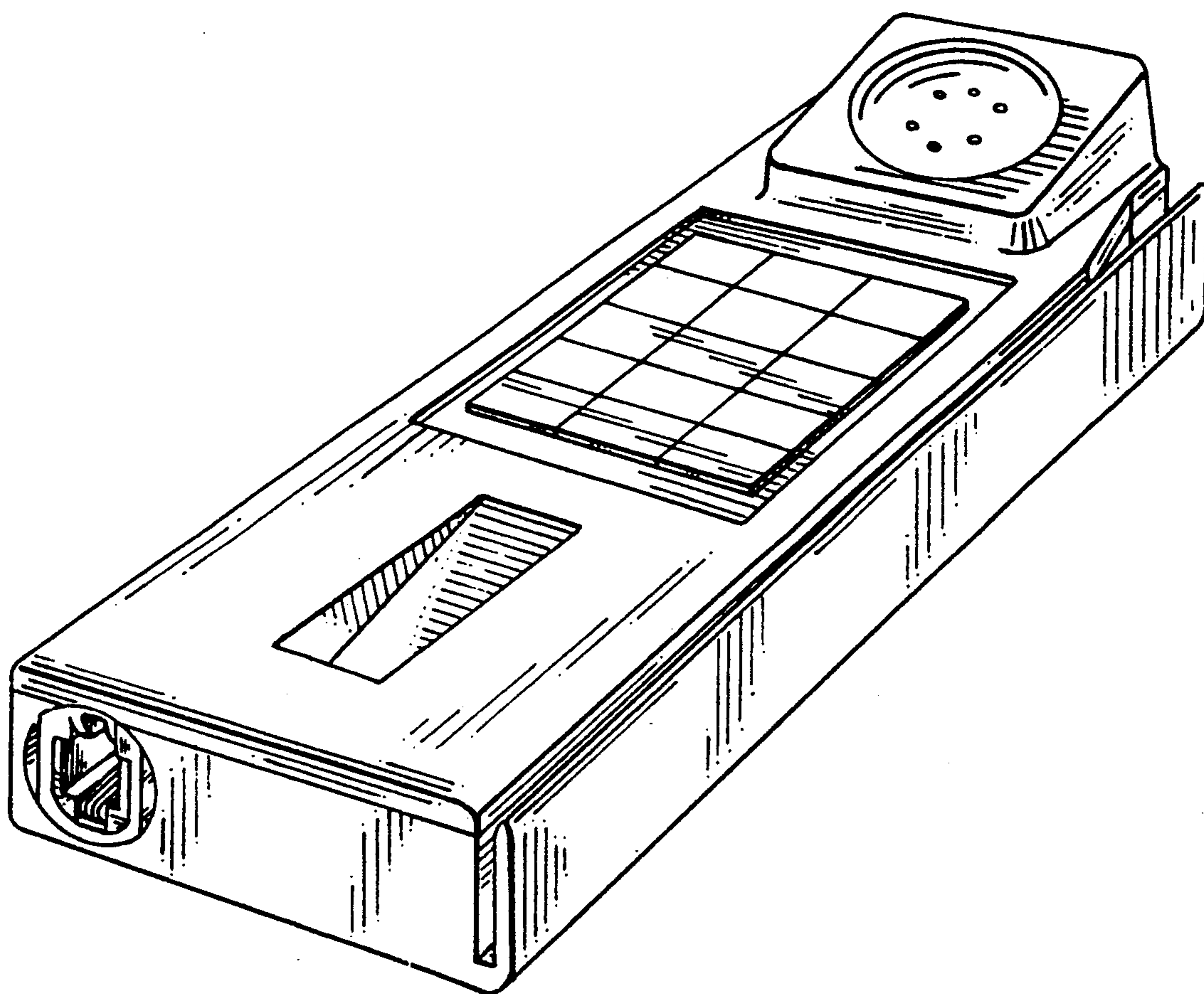

FIG. 5

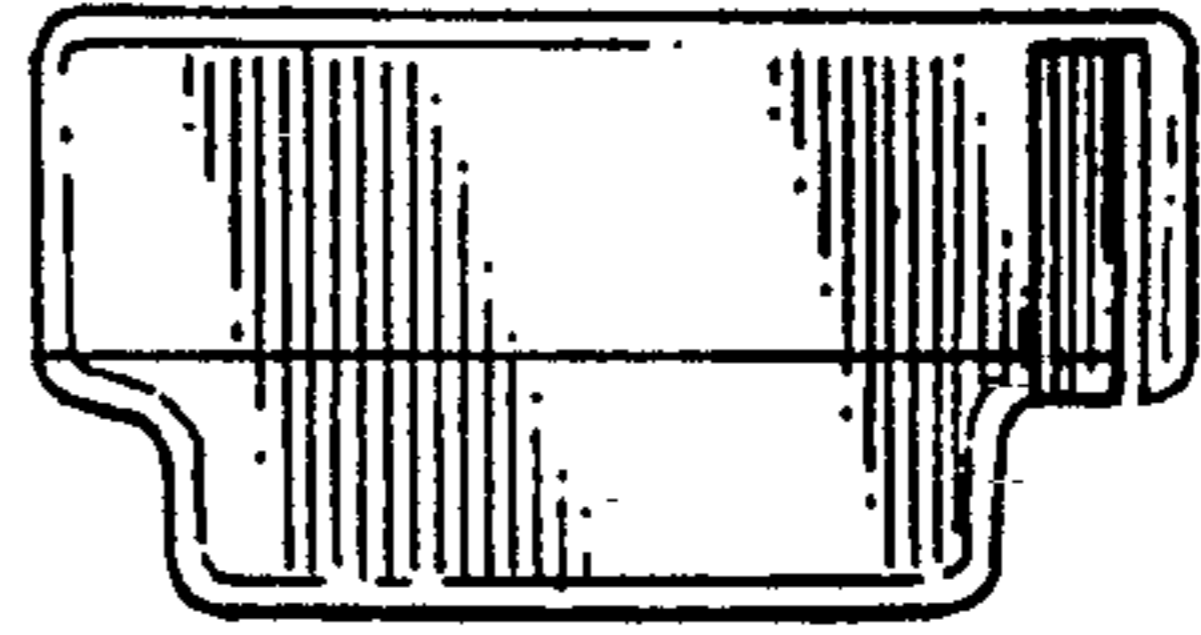

FIG. 3

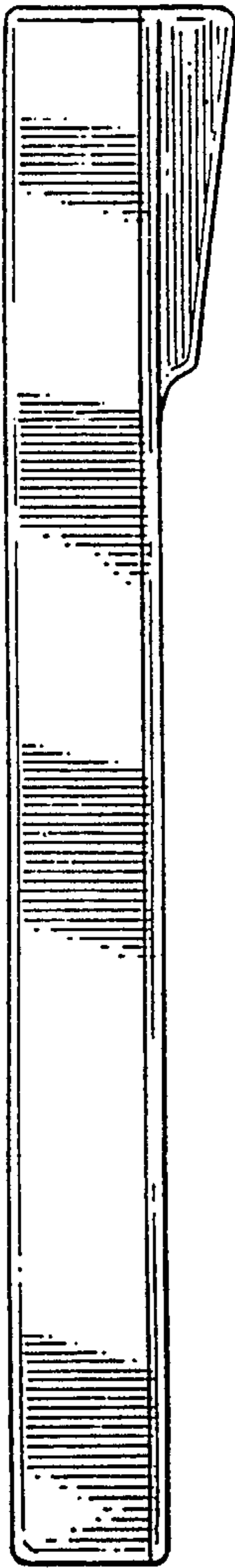

FIG. 2

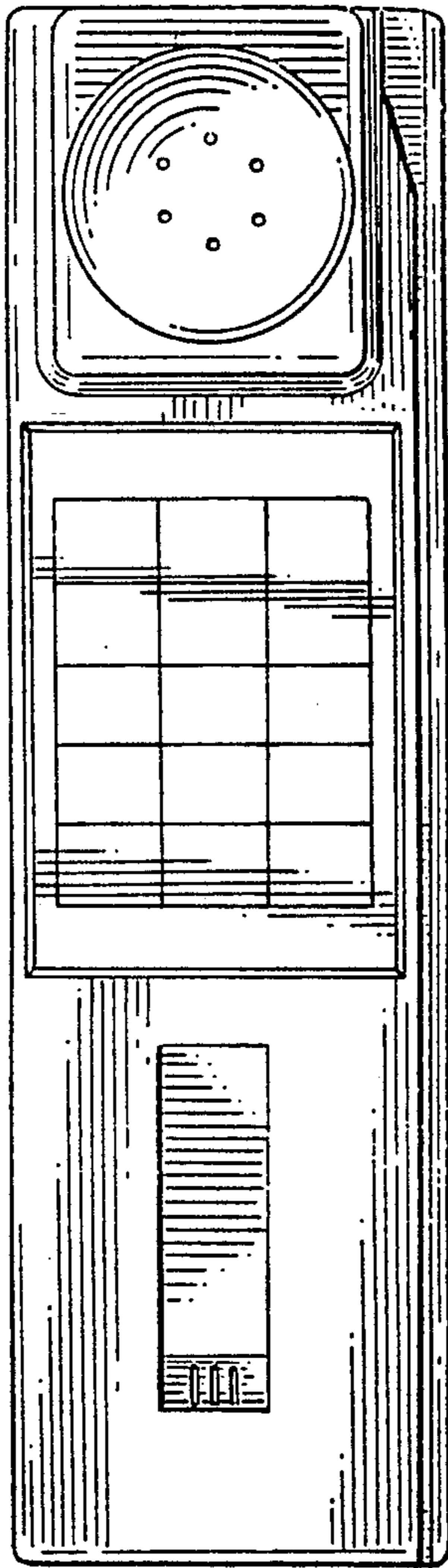

FIG. 4

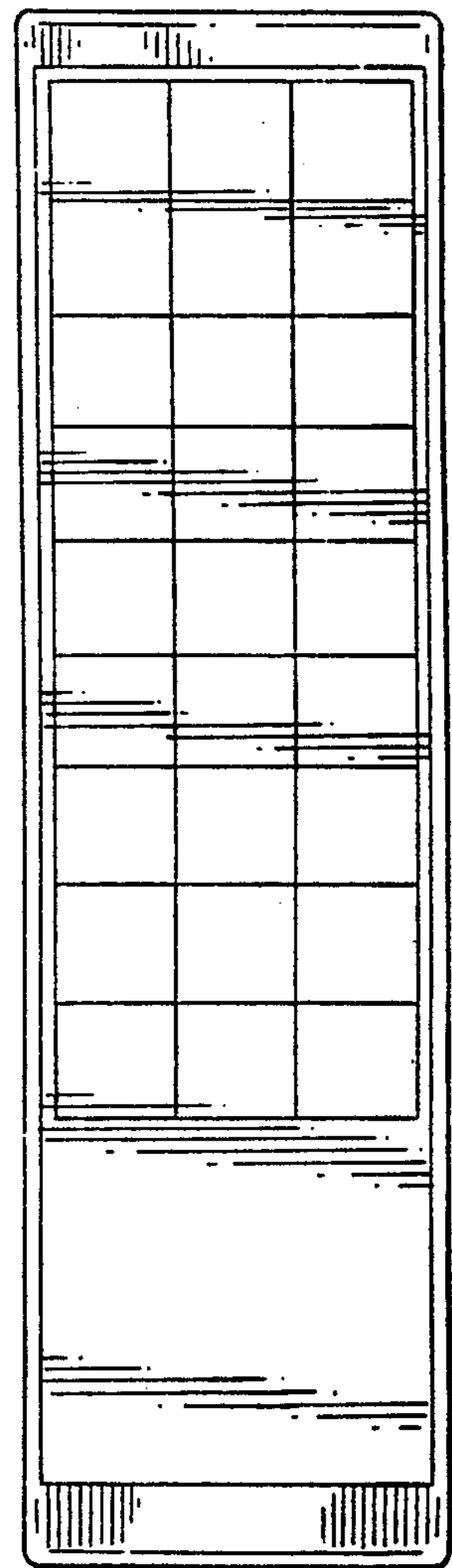
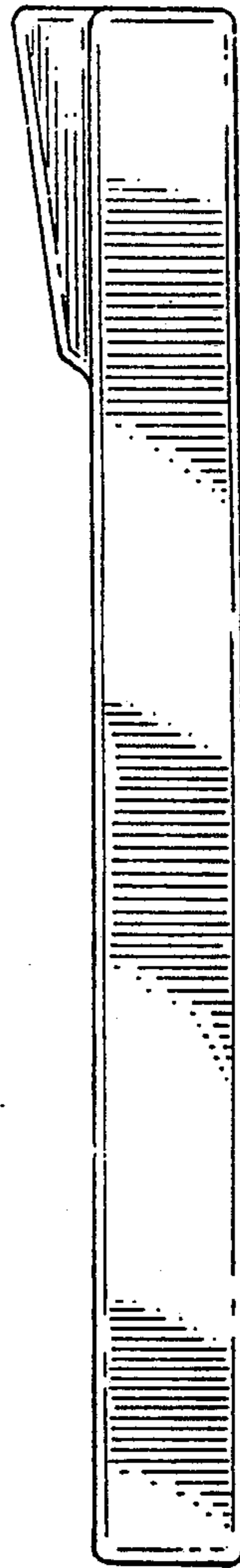

FIG. 7

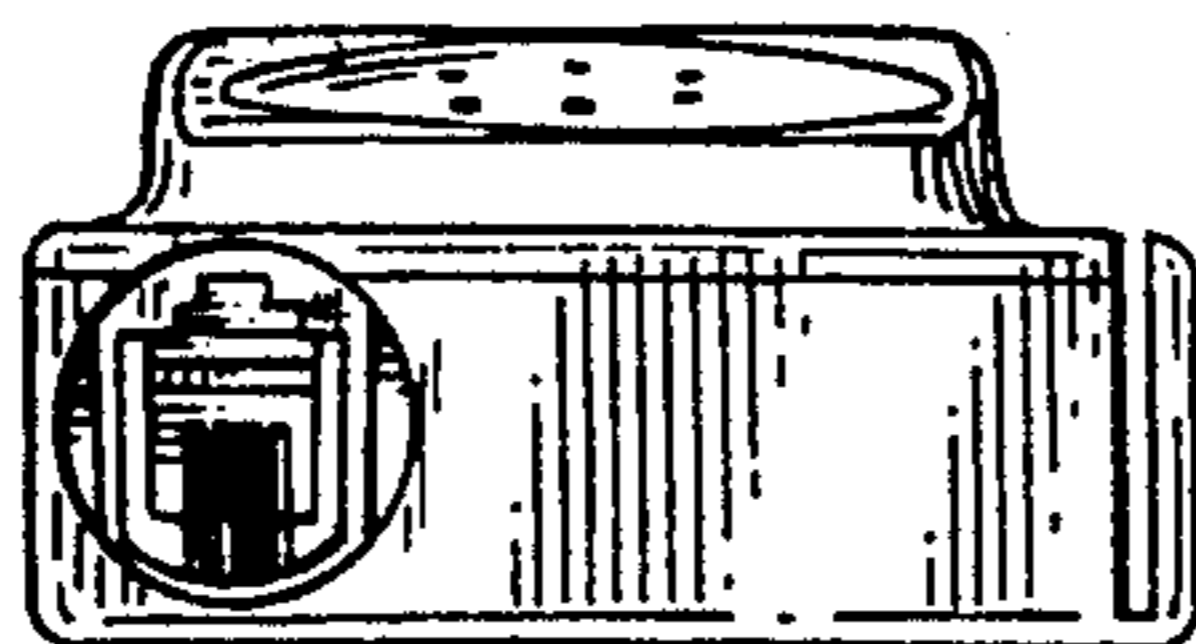

FIG. 6

FIG. 11

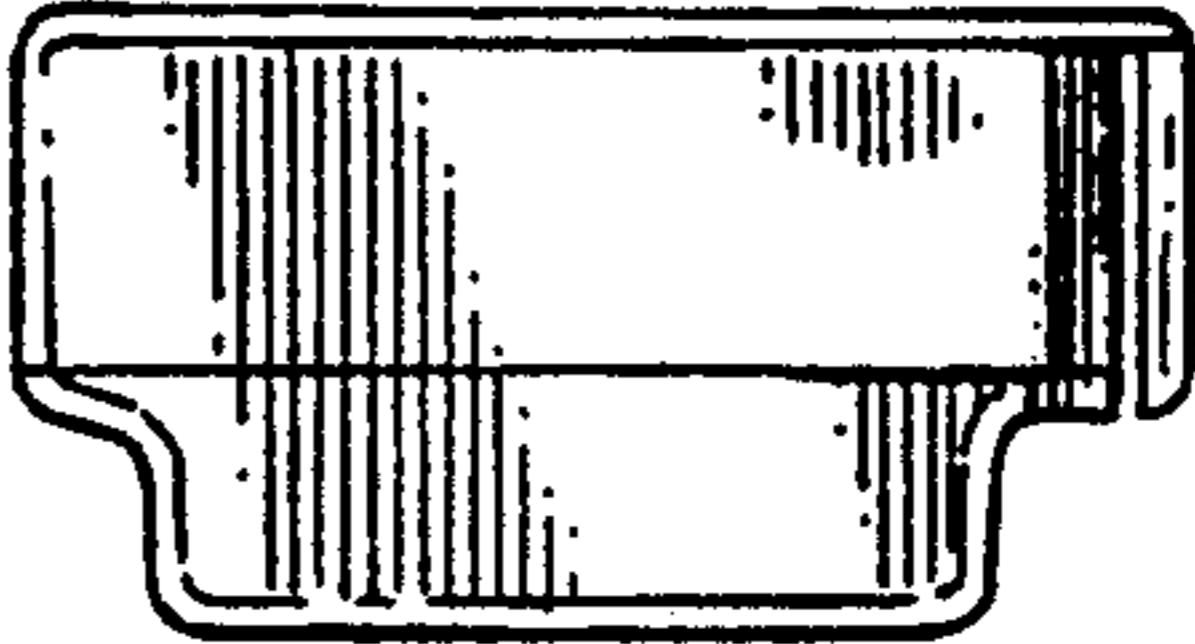

FIG. 9

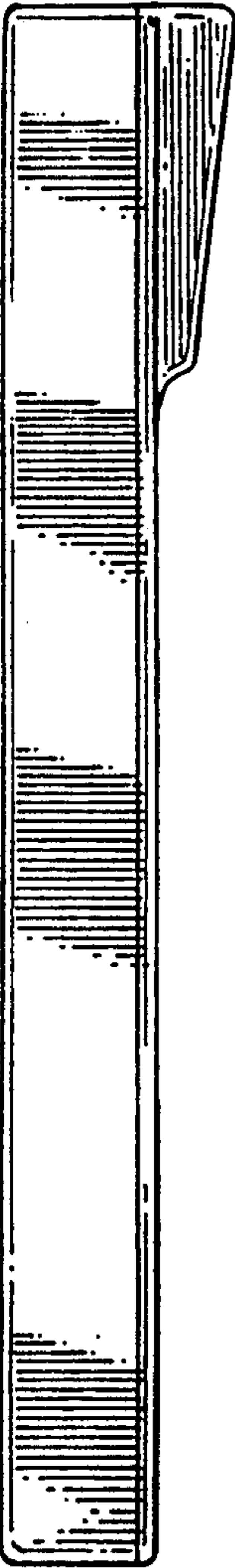

FIG. 8

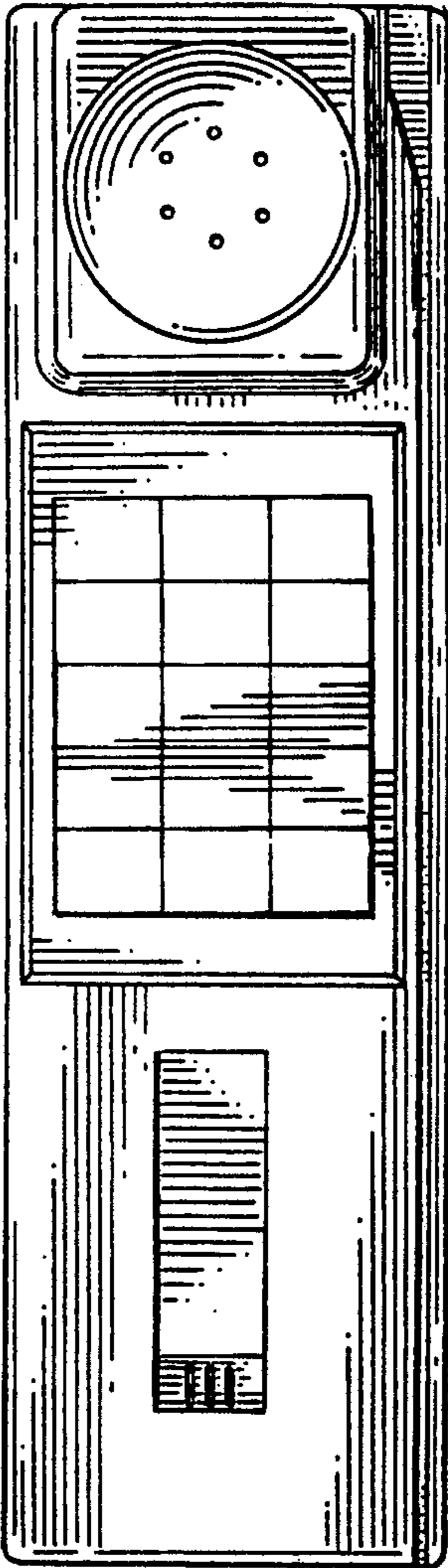

FIG. 10

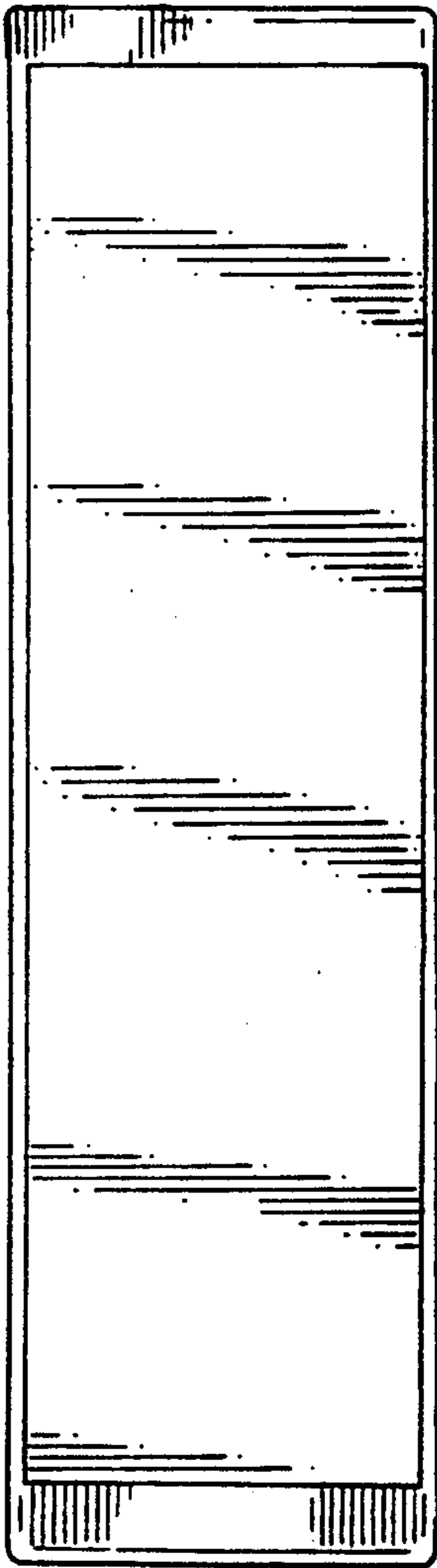
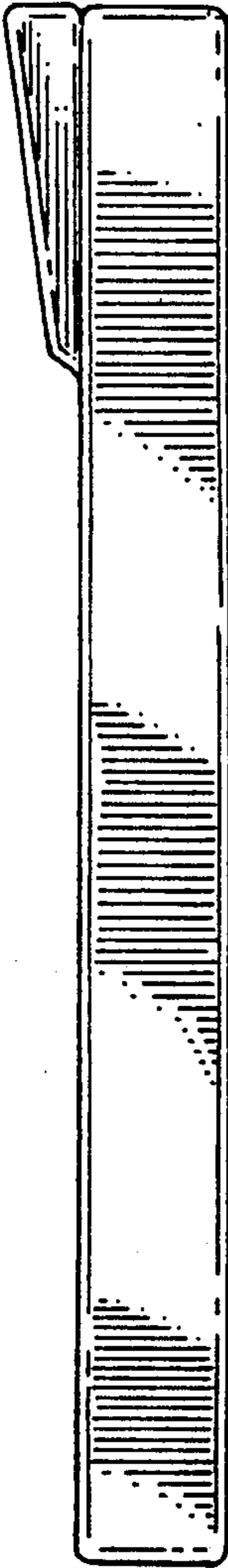

FIG. 13

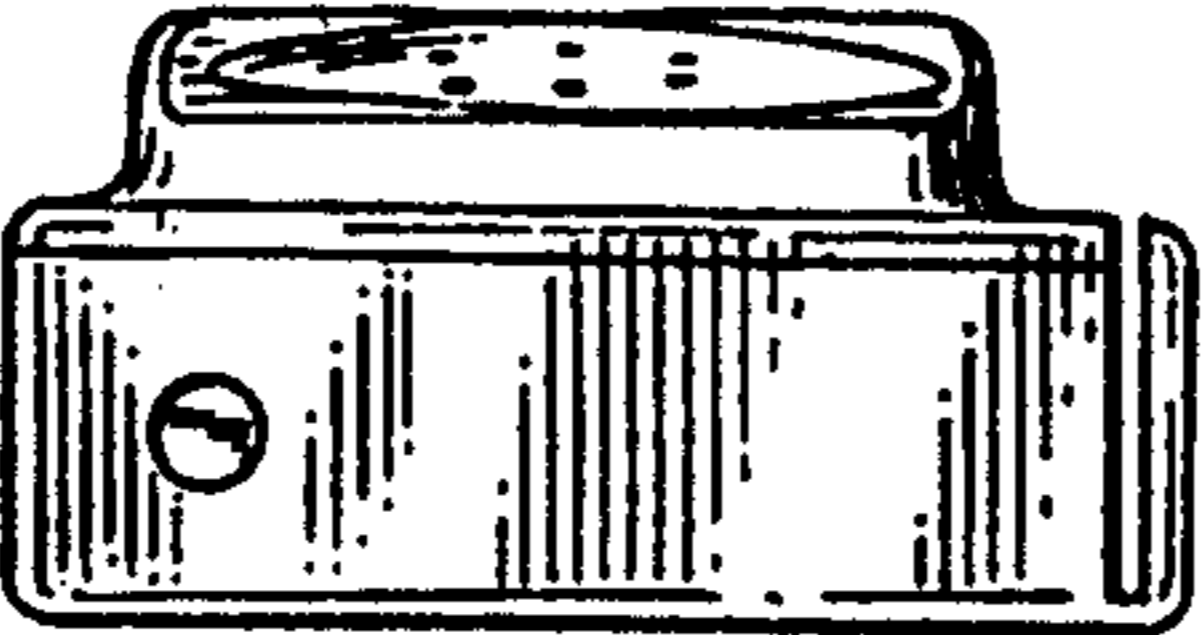

FIG. 12

FIG. 14

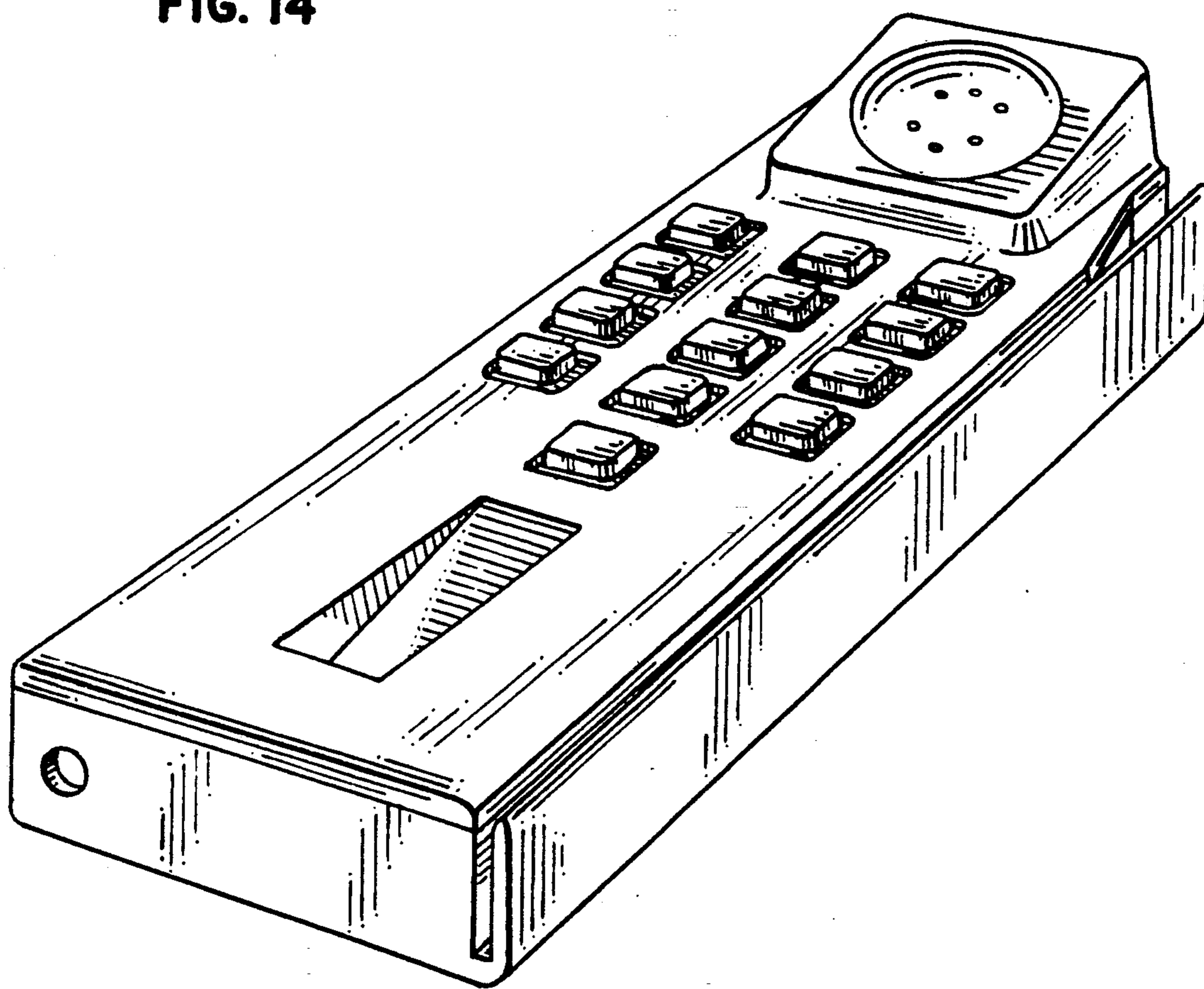

FIG. 18

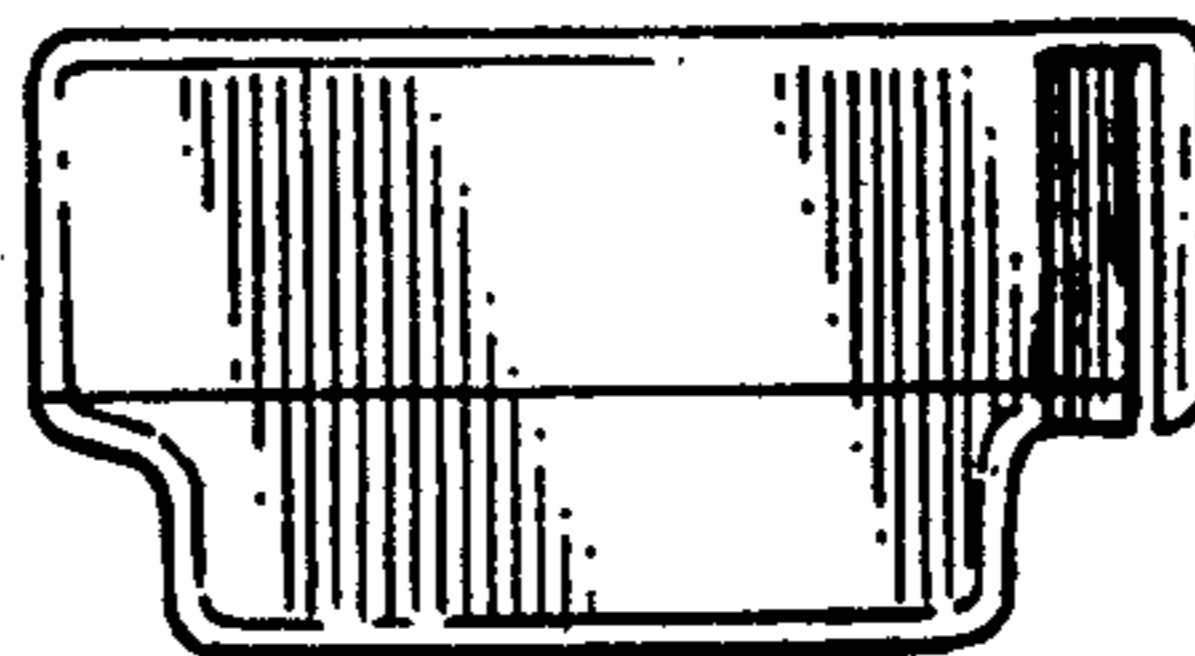

FIG. 16

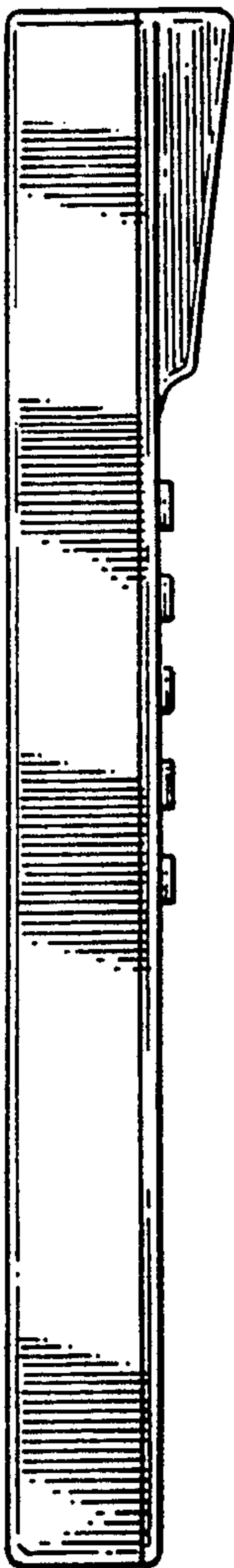

FIG. 15

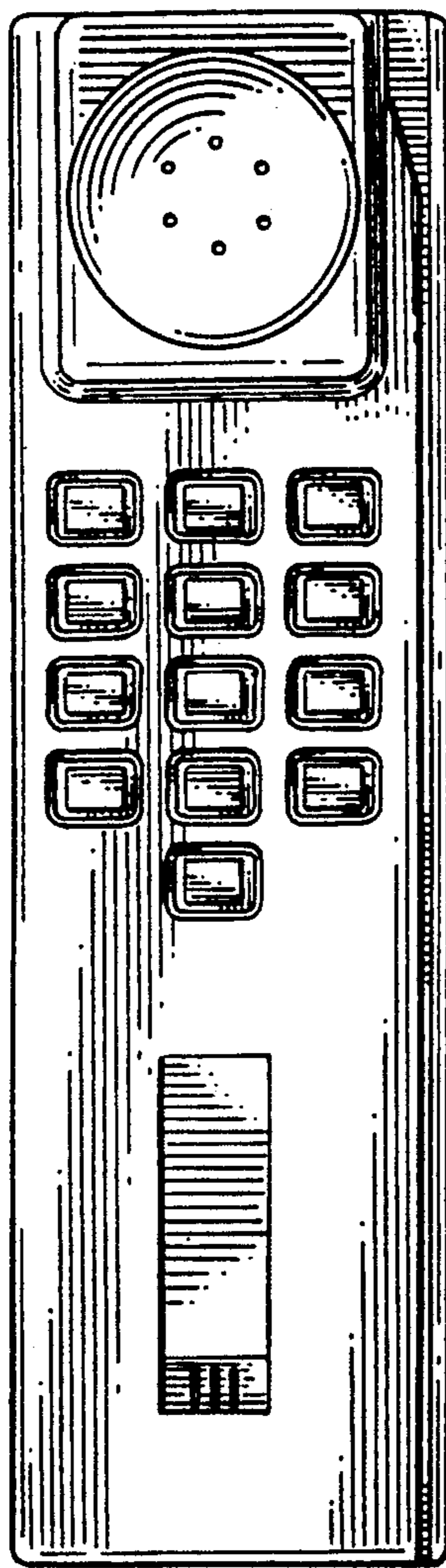

FIG. 17

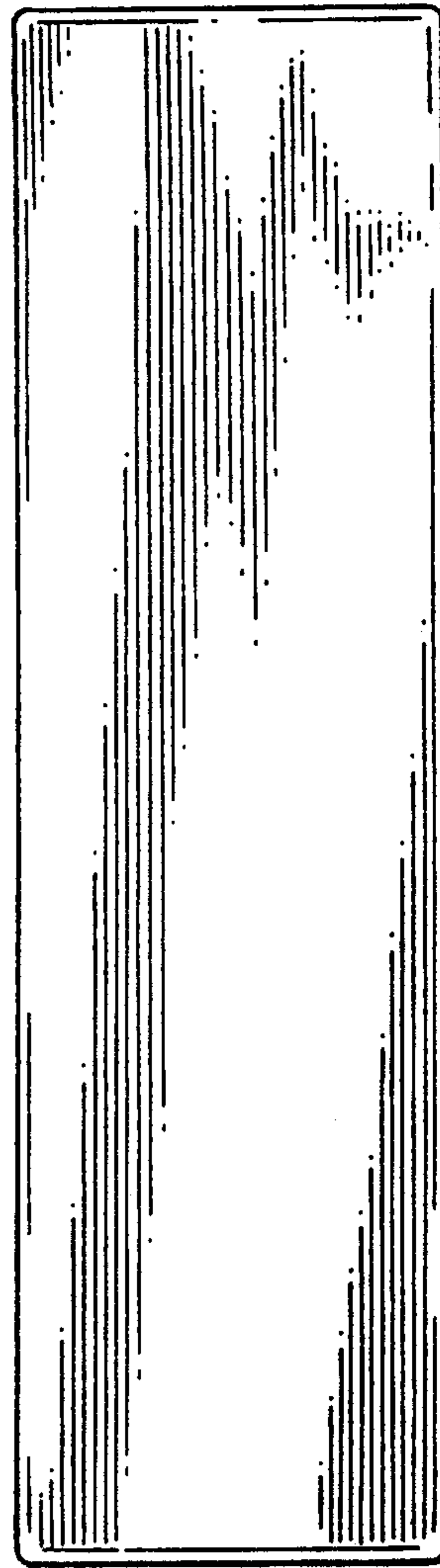
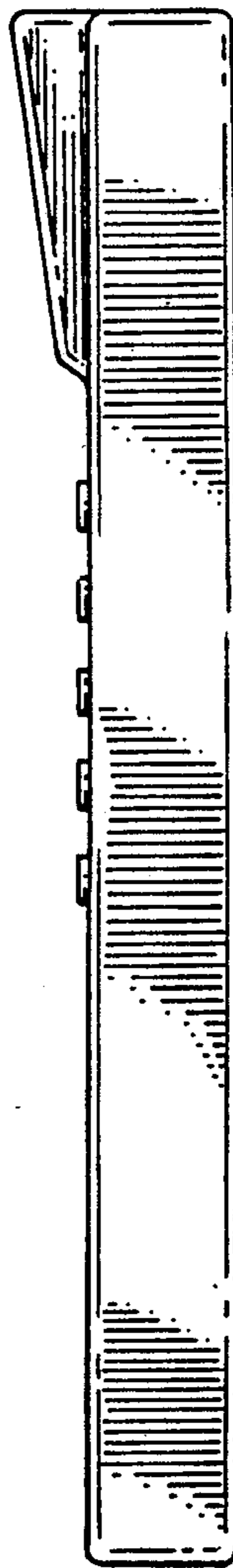

FIG. 20



FIG. 19

FIG. 21

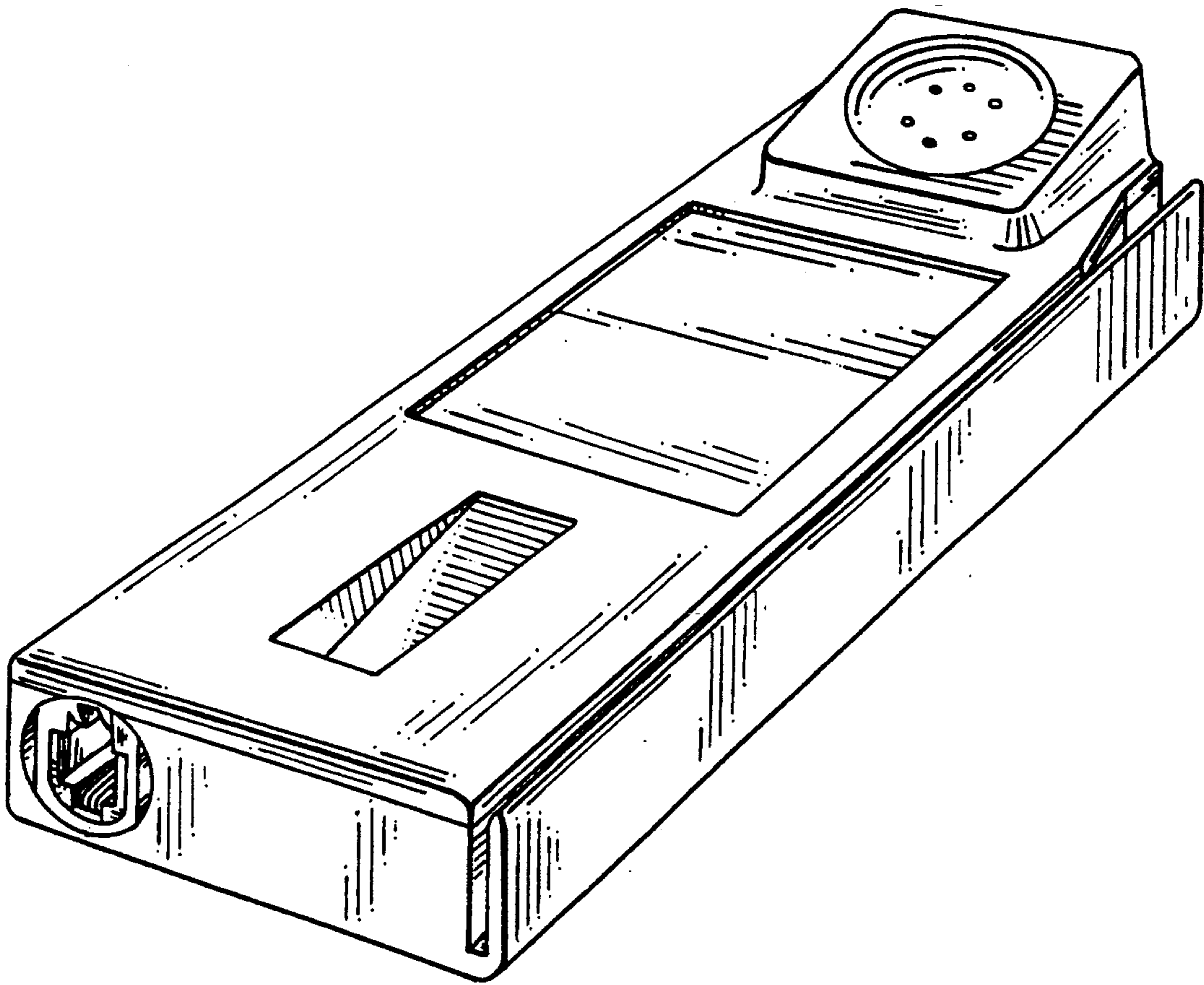

FIG. 25

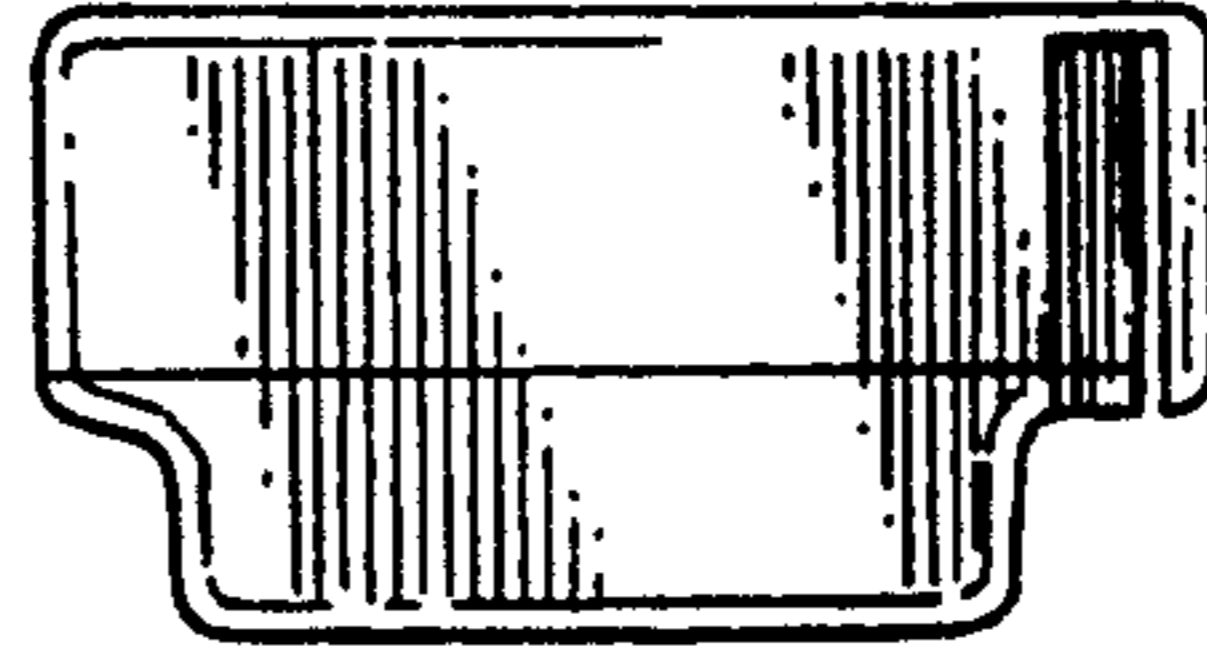

FIG. 23

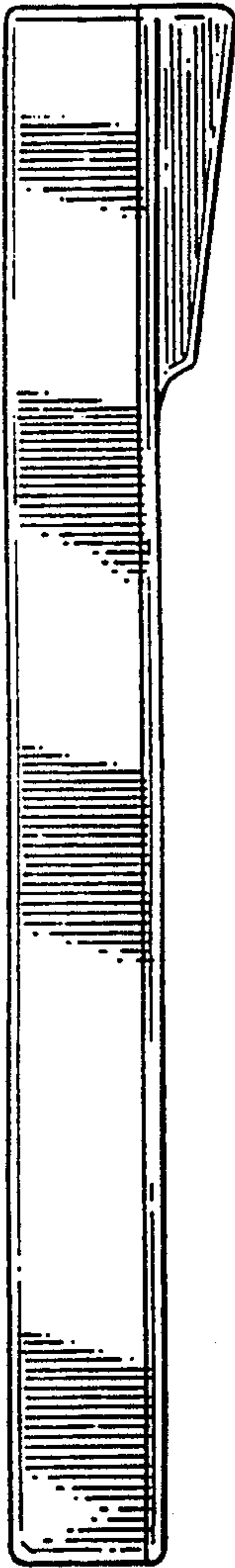

FIG. 22

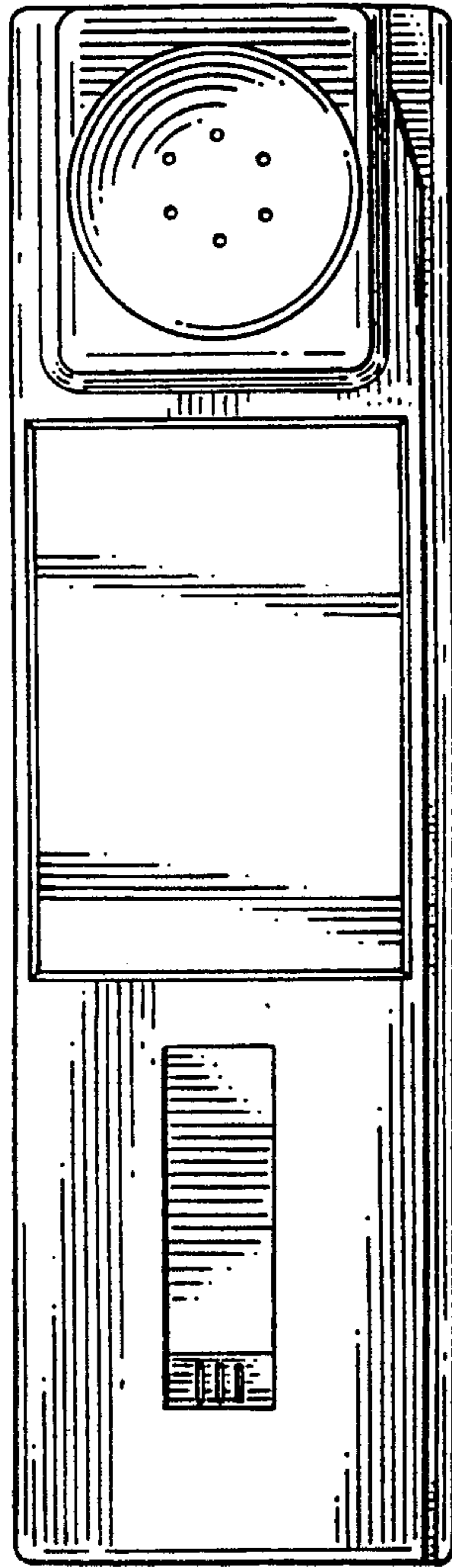

FIG. 24

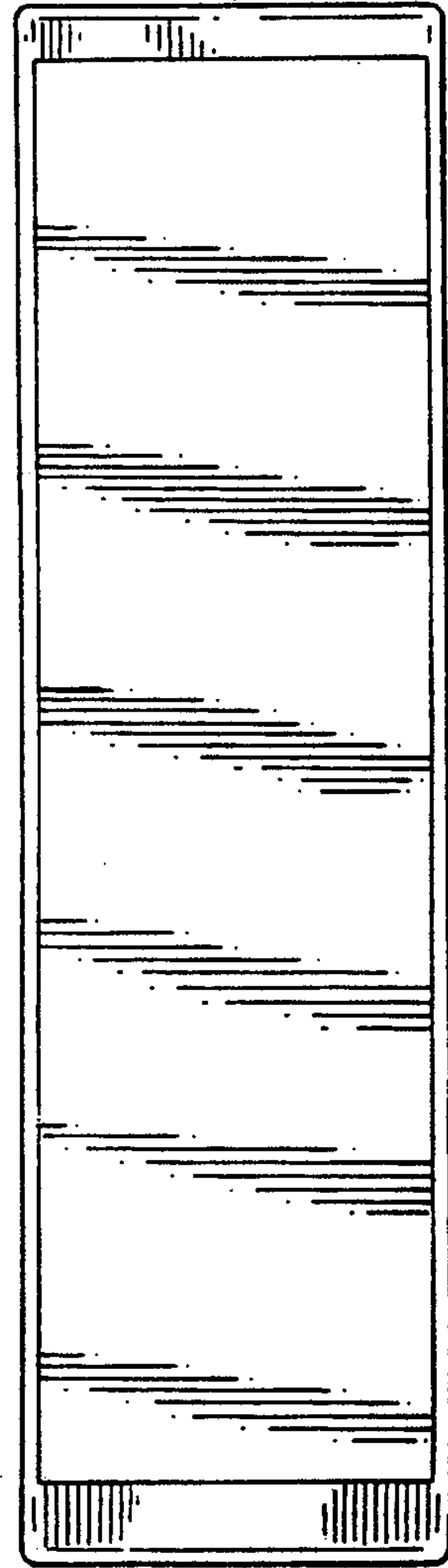
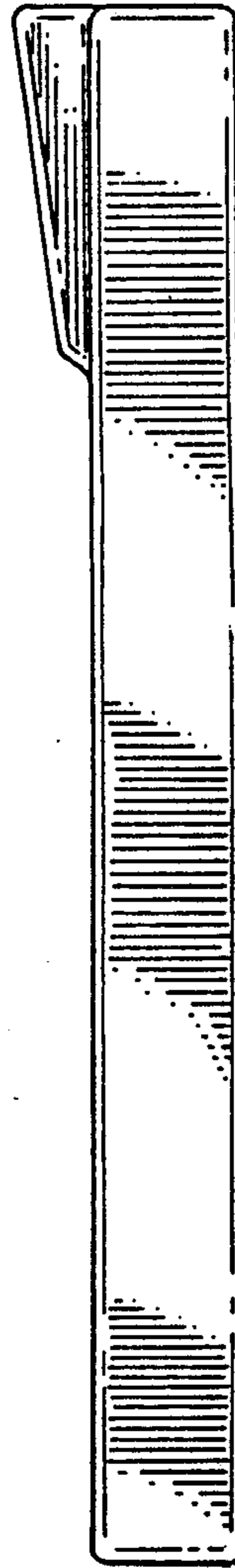

FIG. 27

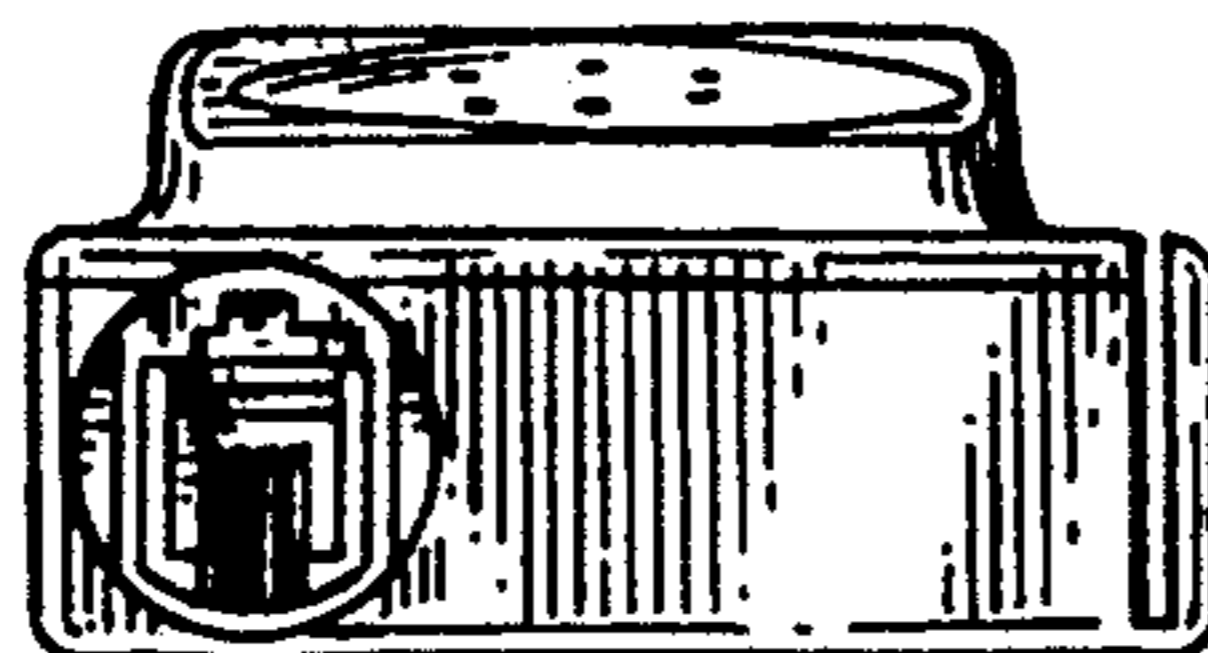

FIG. 26

FIG. 28

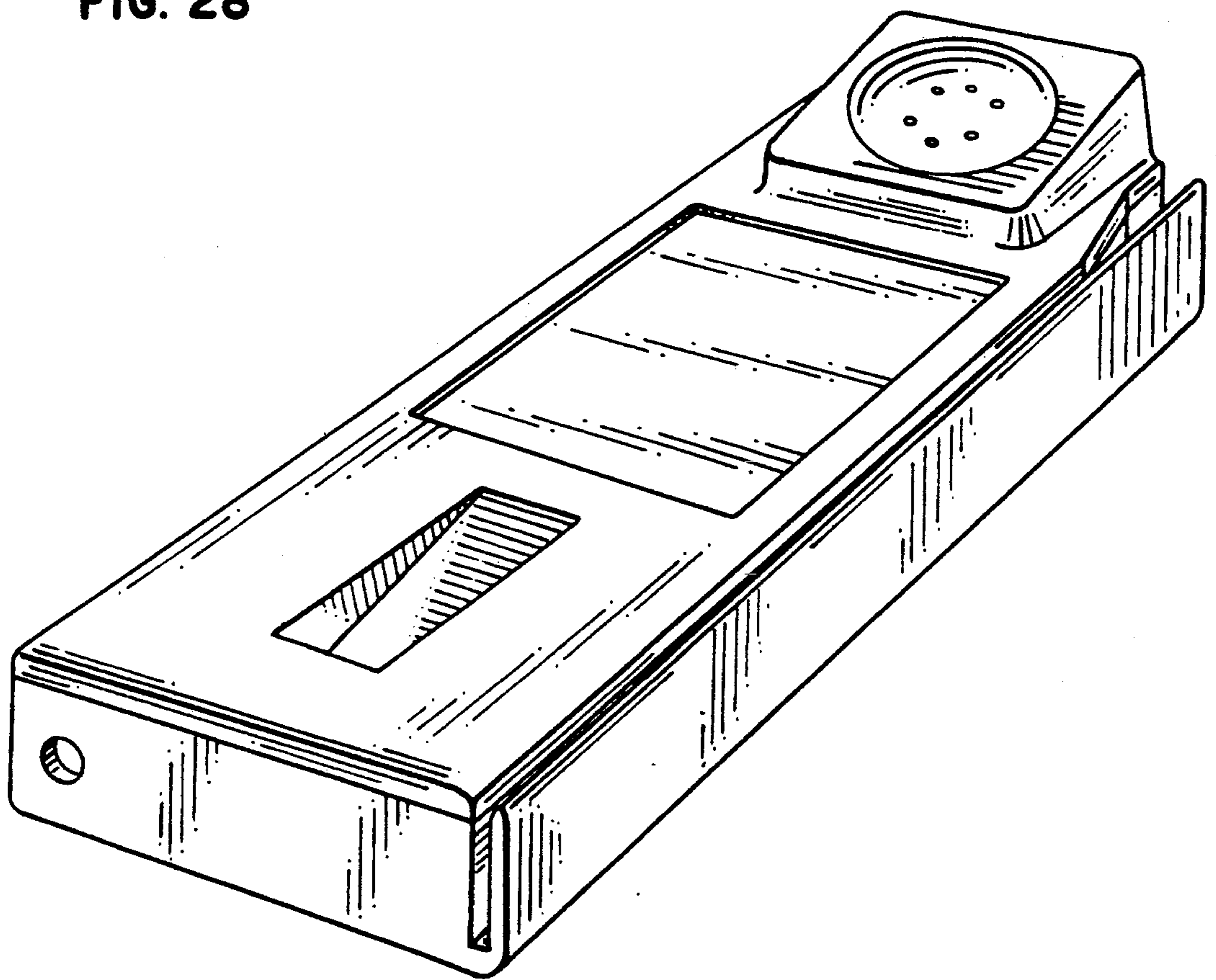

FIG. 32

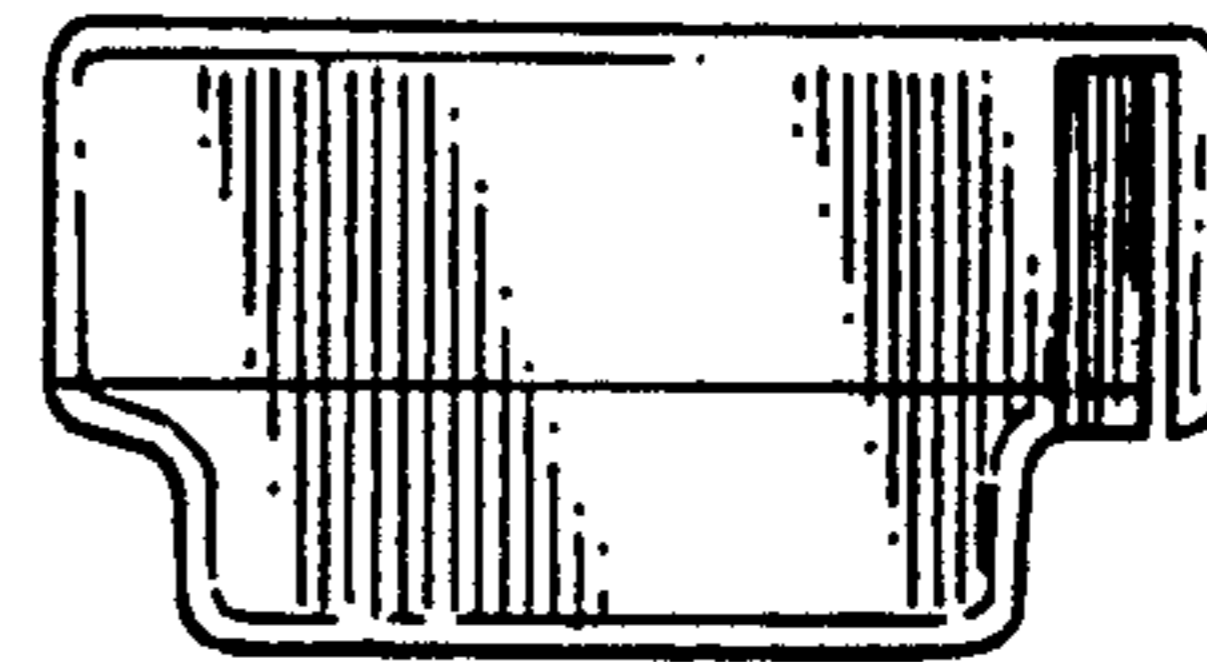

FIG. 30

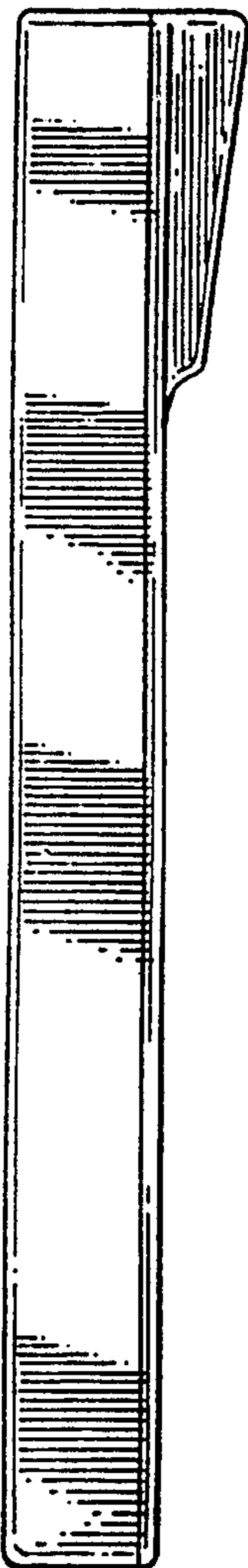

FIG. 29

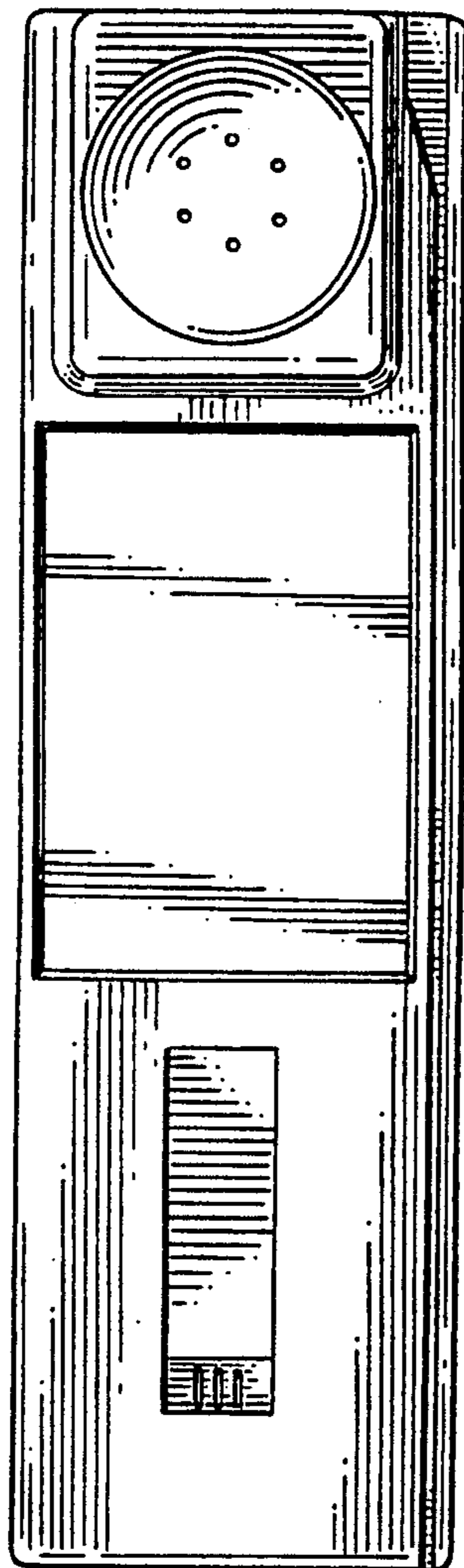

FIG. 31

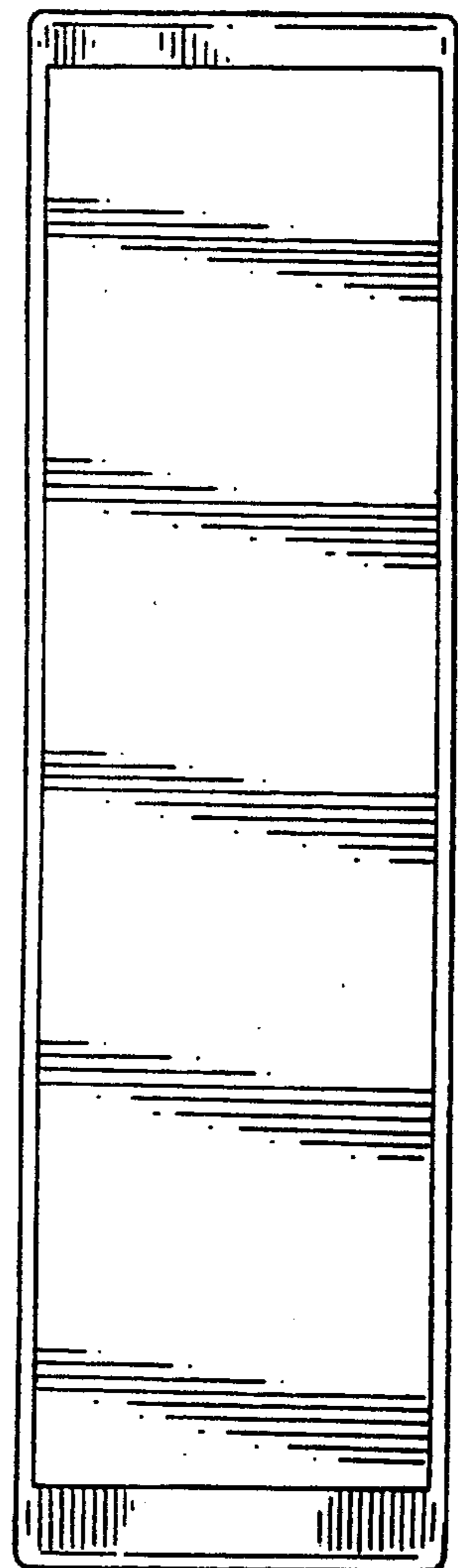
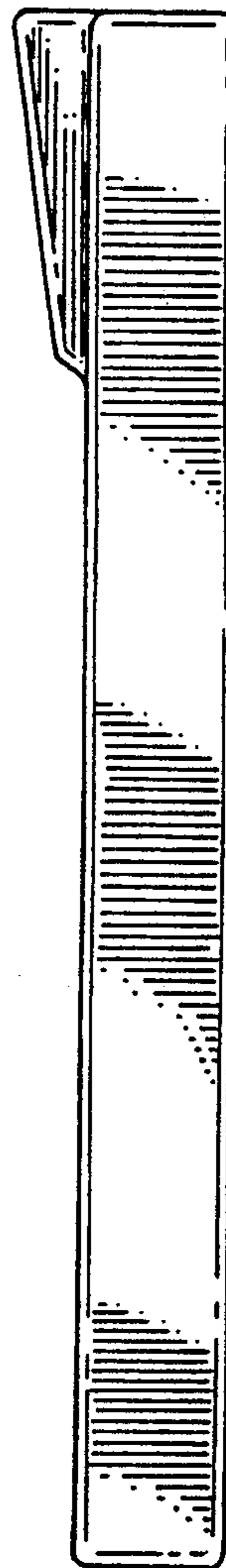

FIG. 34

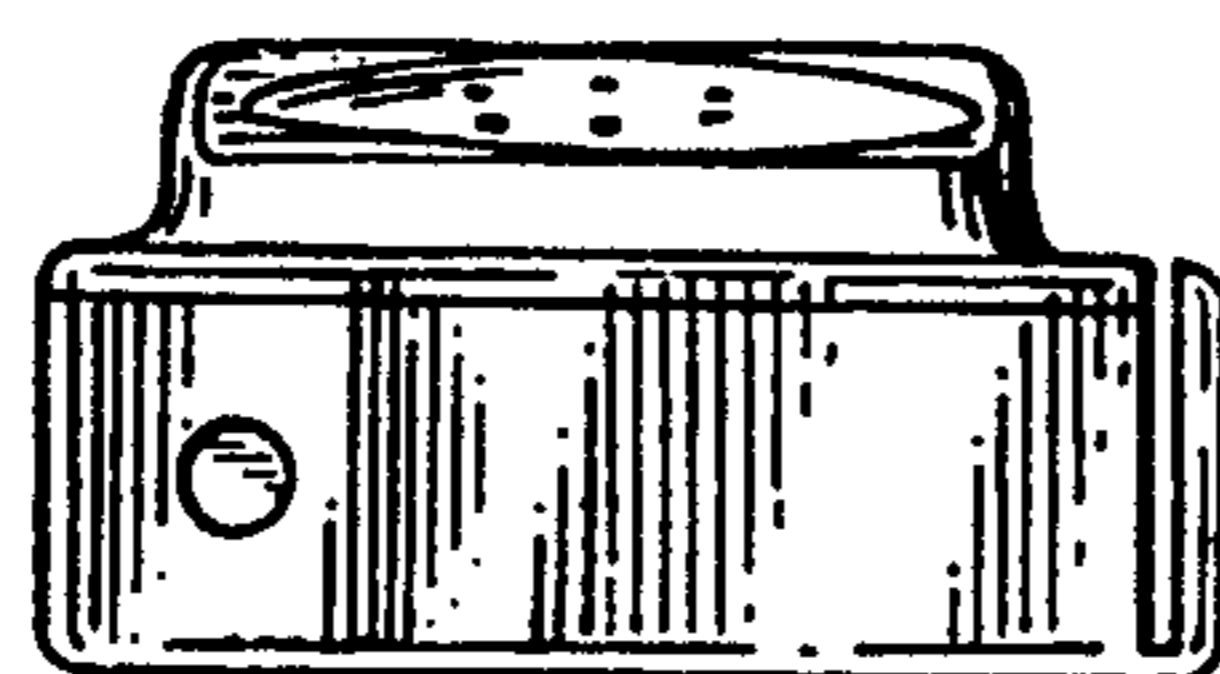

FIG. 33