



US00D326936S

United States Patent [19]
Moore

[11] **Patent Number: Des. 326,936**
[45] **Date of Patent: ** Jun. 9, 1992**

[54] **DOGHOUSE**

4,645,379 2/1987 Grimsley et al. D25/26
4,930,445 6/1990 Chestnut 119/19

[76] Inventor: **Ricky D. Moore, Box 2093,
Chickasha, Okla. 73023**

[**] Term: **14 Years**

[21] Appl. No.: **586,041**

[22] Filed: **Sep. 18, 1990**

[52] U.S. Cl. **D30/108; D25/26**

[58] Field of Search 119/19, 165, 168, 15,
119/16, 17; D6/450; D30/108-109, 112-118,
120, 165, 101, 107, 104; 229/120.1, 120;
D21/253; D25/22, 23, 29, 17, 13, 26; D11/145

OTHER PUBLICATIONS

Architectural Record; Oct. 1957; p. 259; Tetrahedron
(top left corner).
Domus; Aug. 1979; p. 42; (Building at top right).

Primary Examiner—A. Hugo Word
Assistant Examiner—Cathy Anne MacCormac
Attorney, Agent, or Firm—Dunlap, Coddling & Lee

[56] **References Cited**

U.S. PATENT DOCUMENTS

D. 208,748	9/1967	Kirkham	D21/253
D. 233,986	12/1974	Jones	D25/23
D. 305,681	1/1990	Moss	D21/253
4,064,662	12/1977	O'Toole	D25/26
4,516,529	5/1985	Lotito et al.	119/5
4,520,758	6/1985	Pfriender	119/19
4,639,101	1/1987	Stefancin, Jr.	119/5

[57] **CLAIM**

The ornamental design for a doghouse, as shown and described.

DESCRIPTION

FIG. 1 is a top, front and left side perspective view of a doghouse showing my new design;
FIG. 2 is a front elevational view thereof;
FIG. 3 is a rear elevational view thereof;
FIG. 4 is a right side elevational view thereof;
FIG. 5 is a left side elevational view thereof;
FIG. 6 is a top plan view thereof; and,
FIG. 7 is a bottom plan view thereof

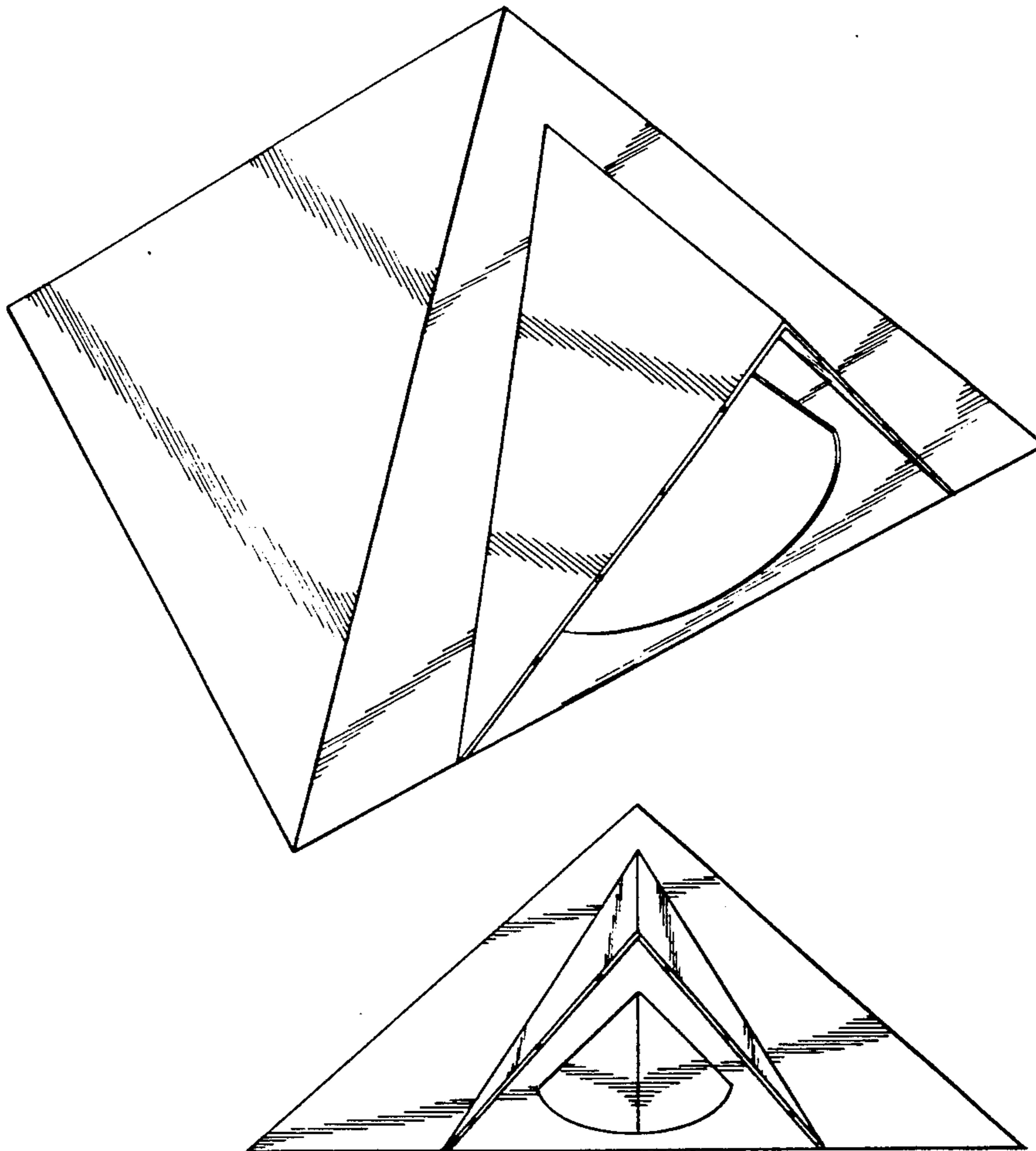

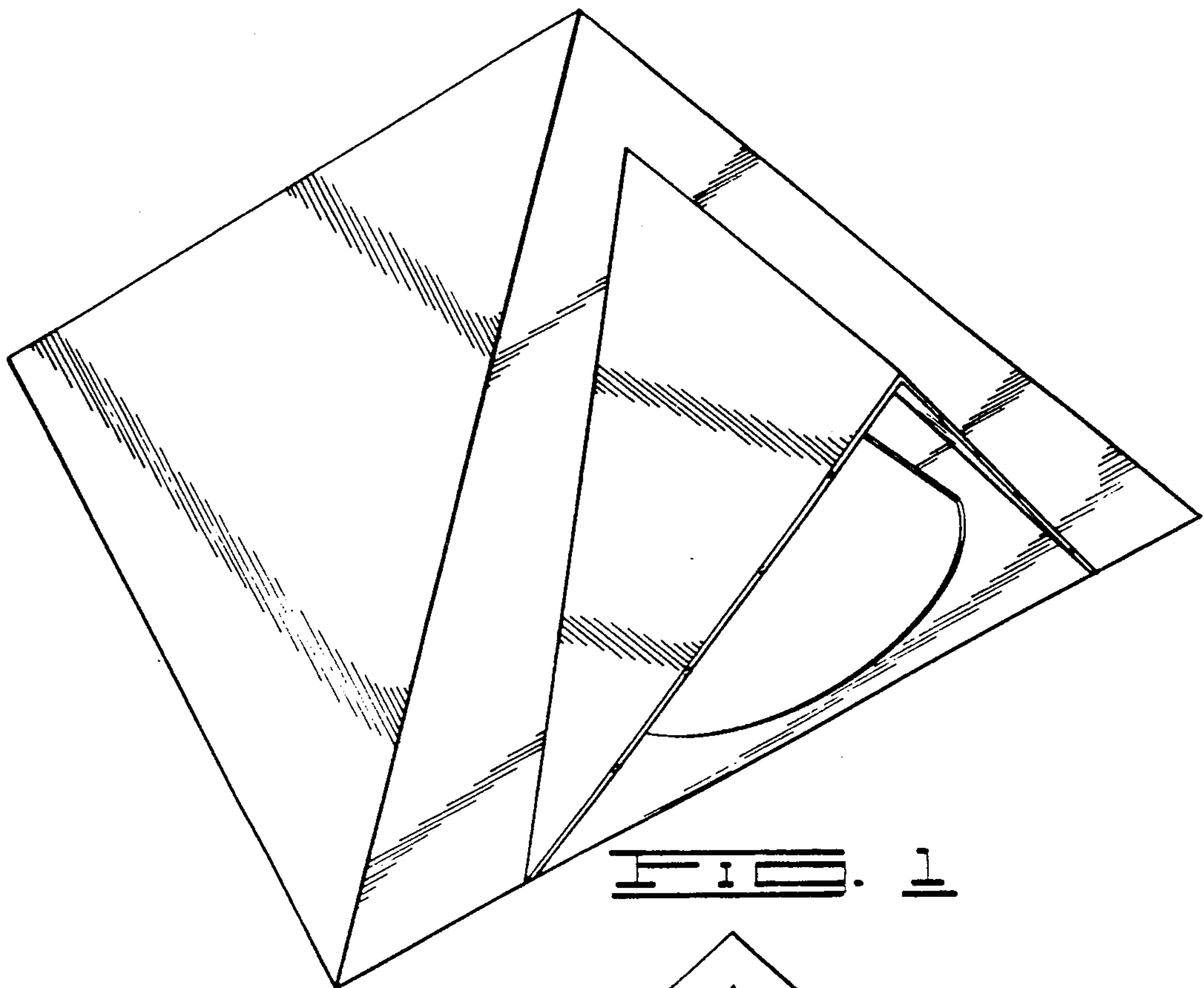

FIG. 1

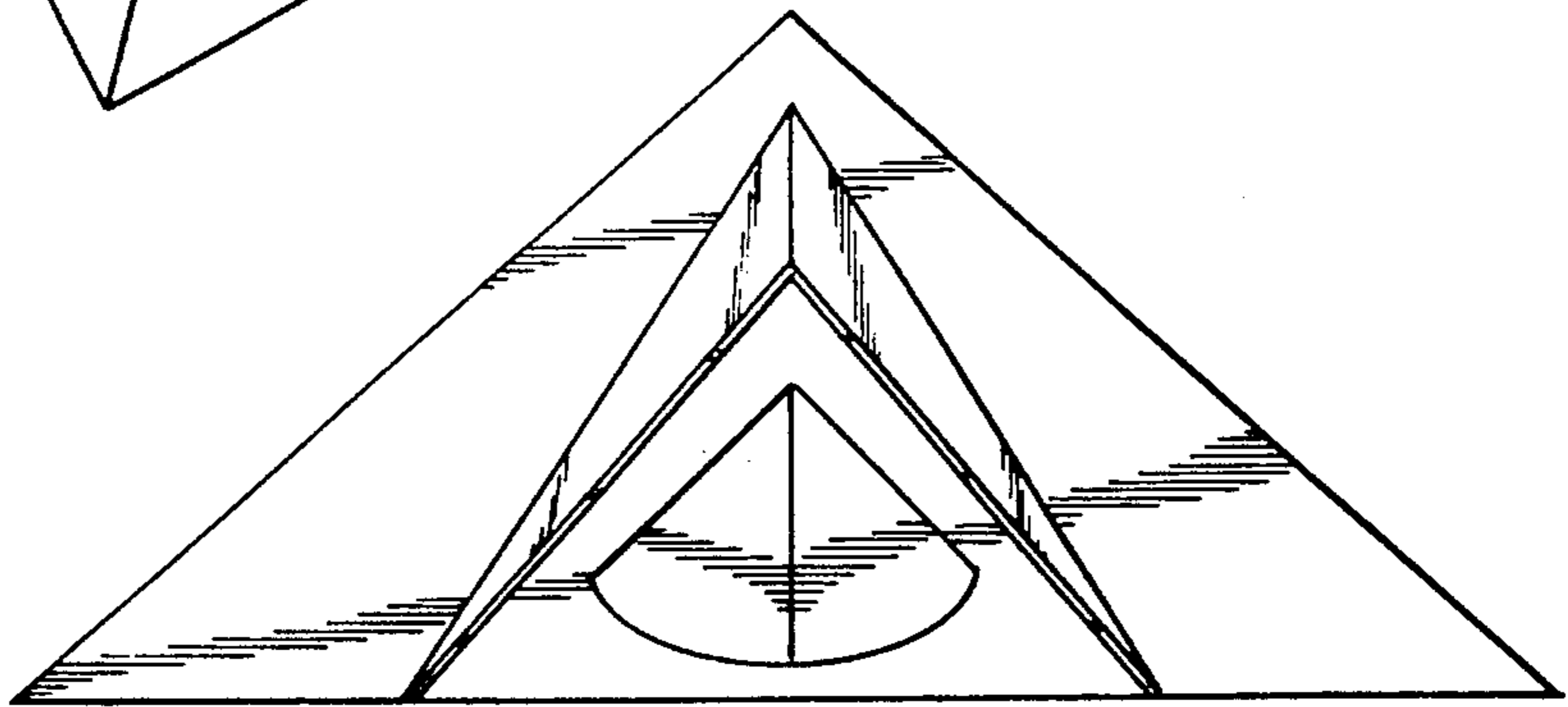

FIG. 2

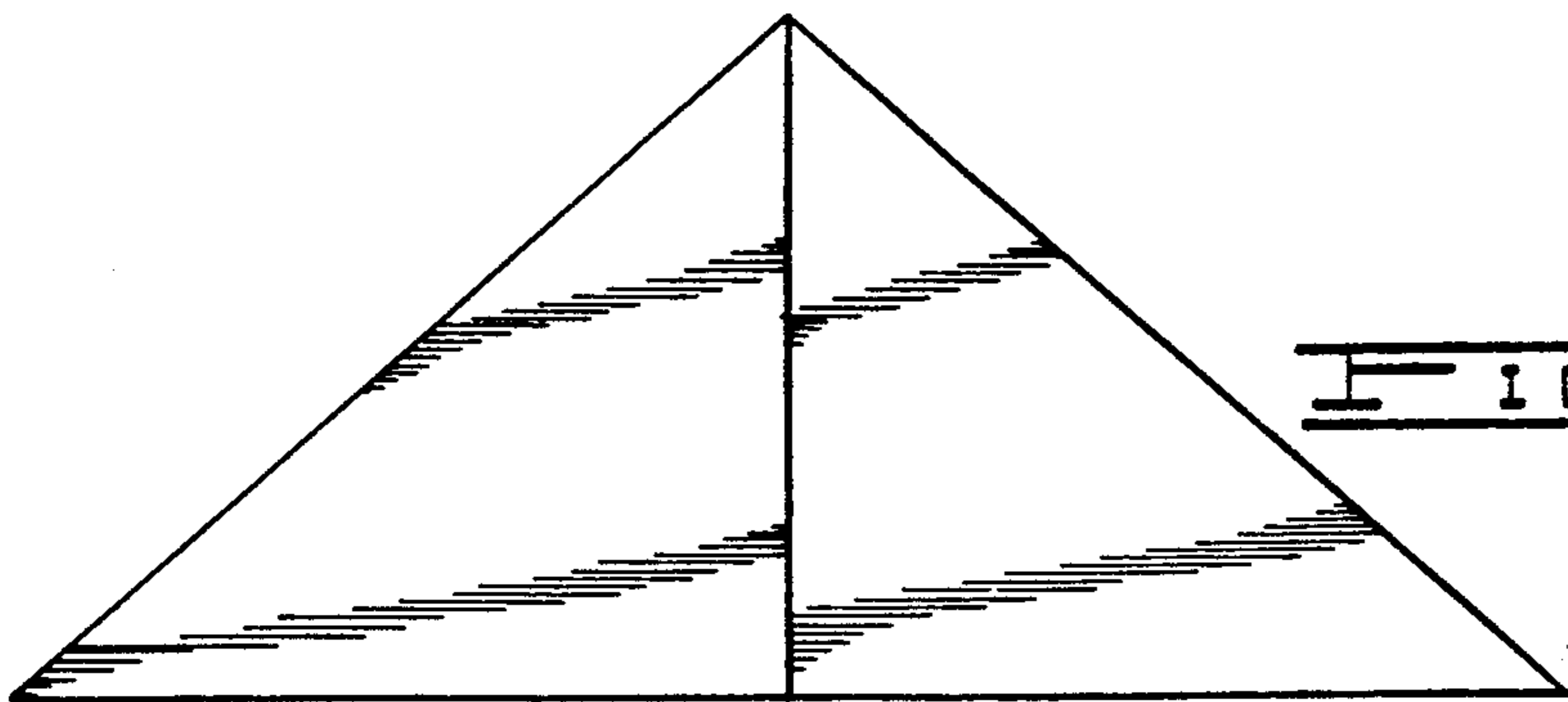

FIG. 3

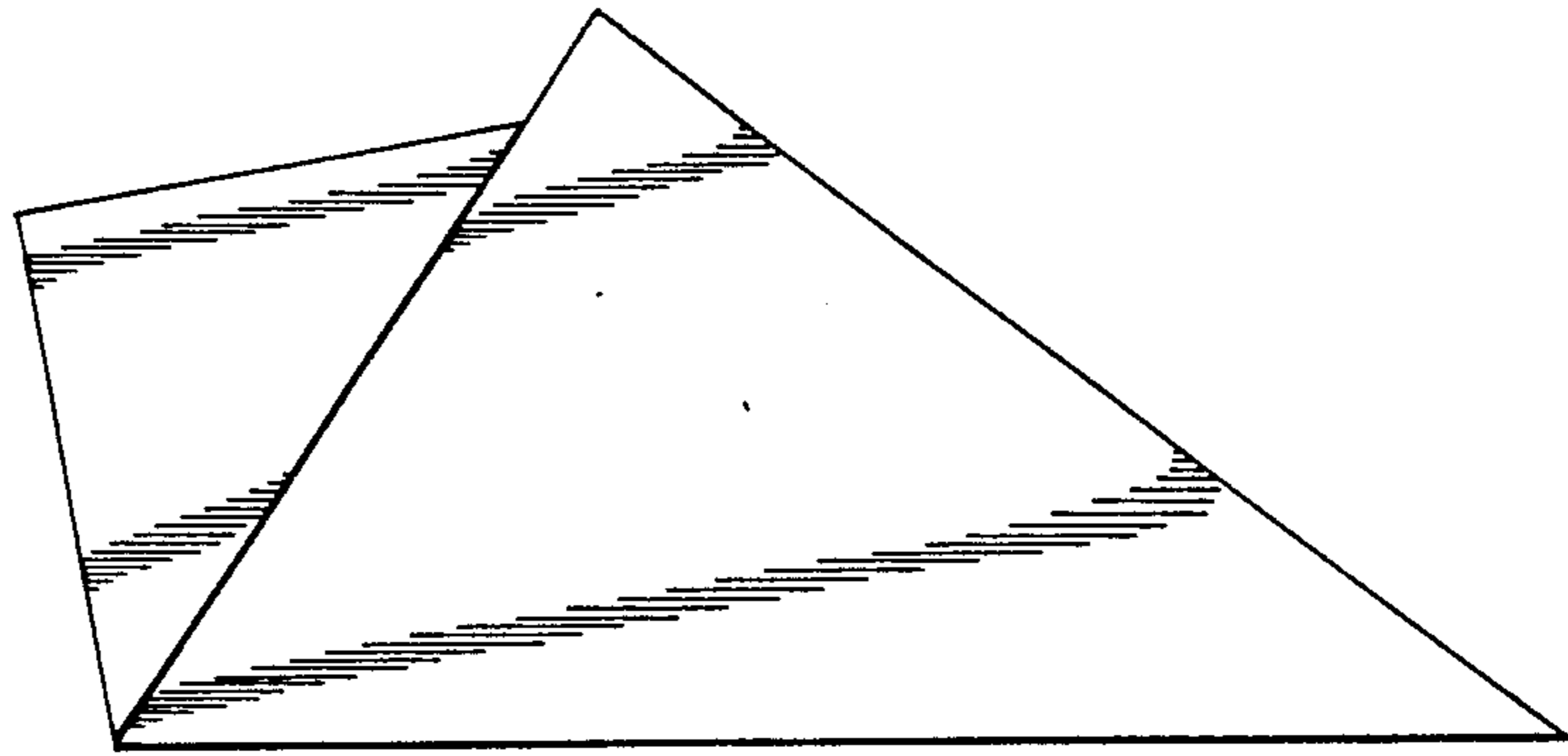

FIG. 4

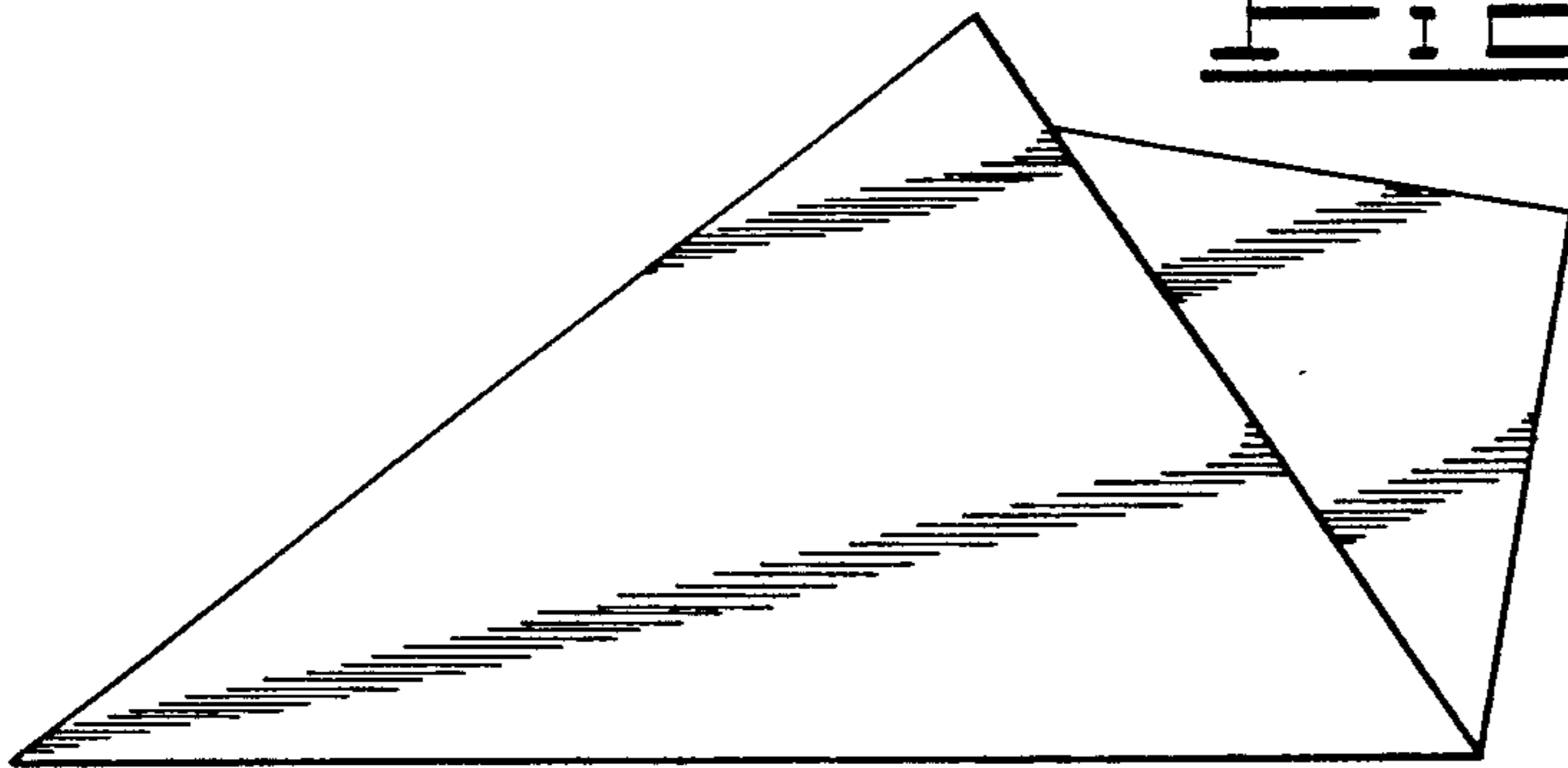

FIG. 5

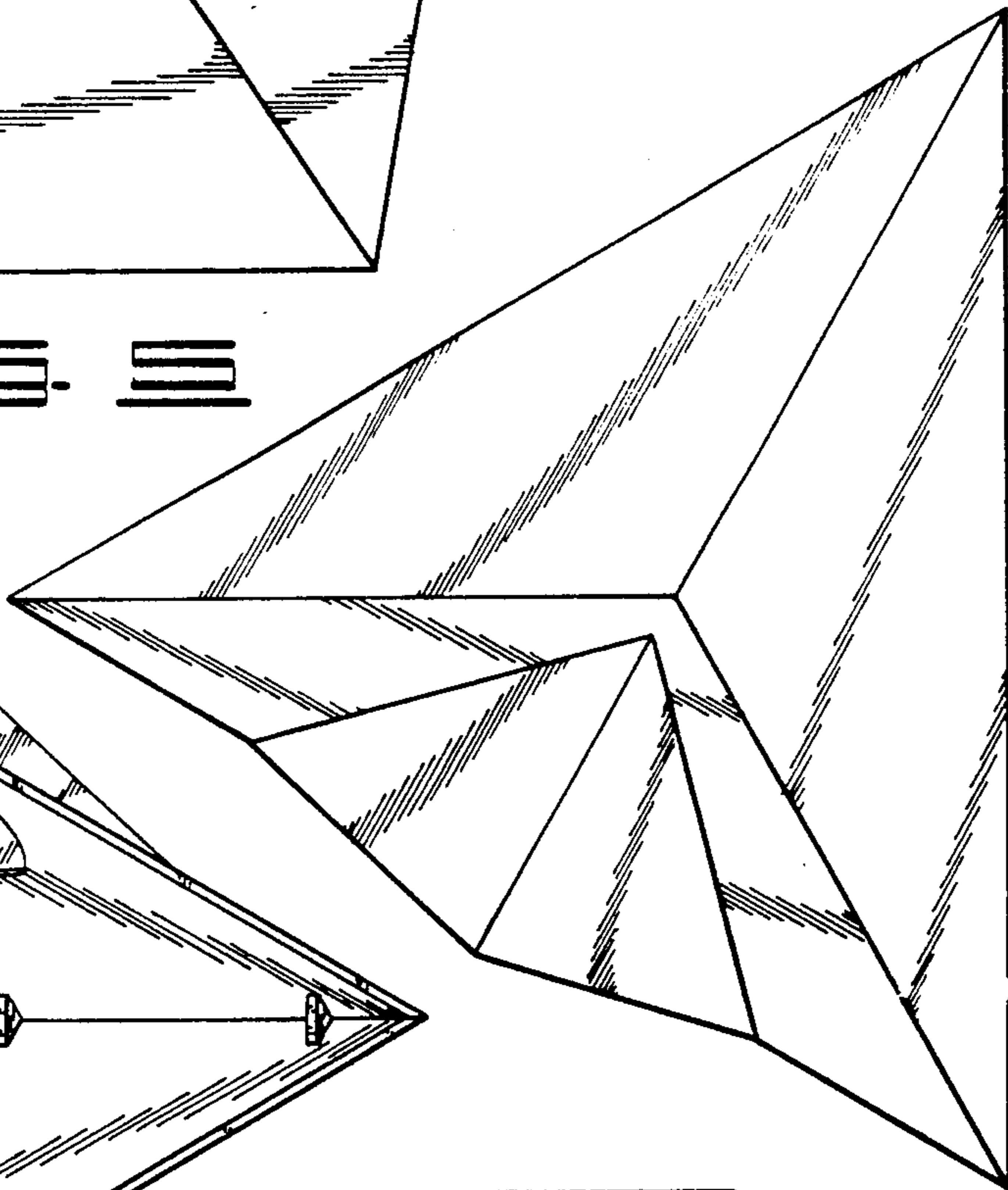

FIG. 6

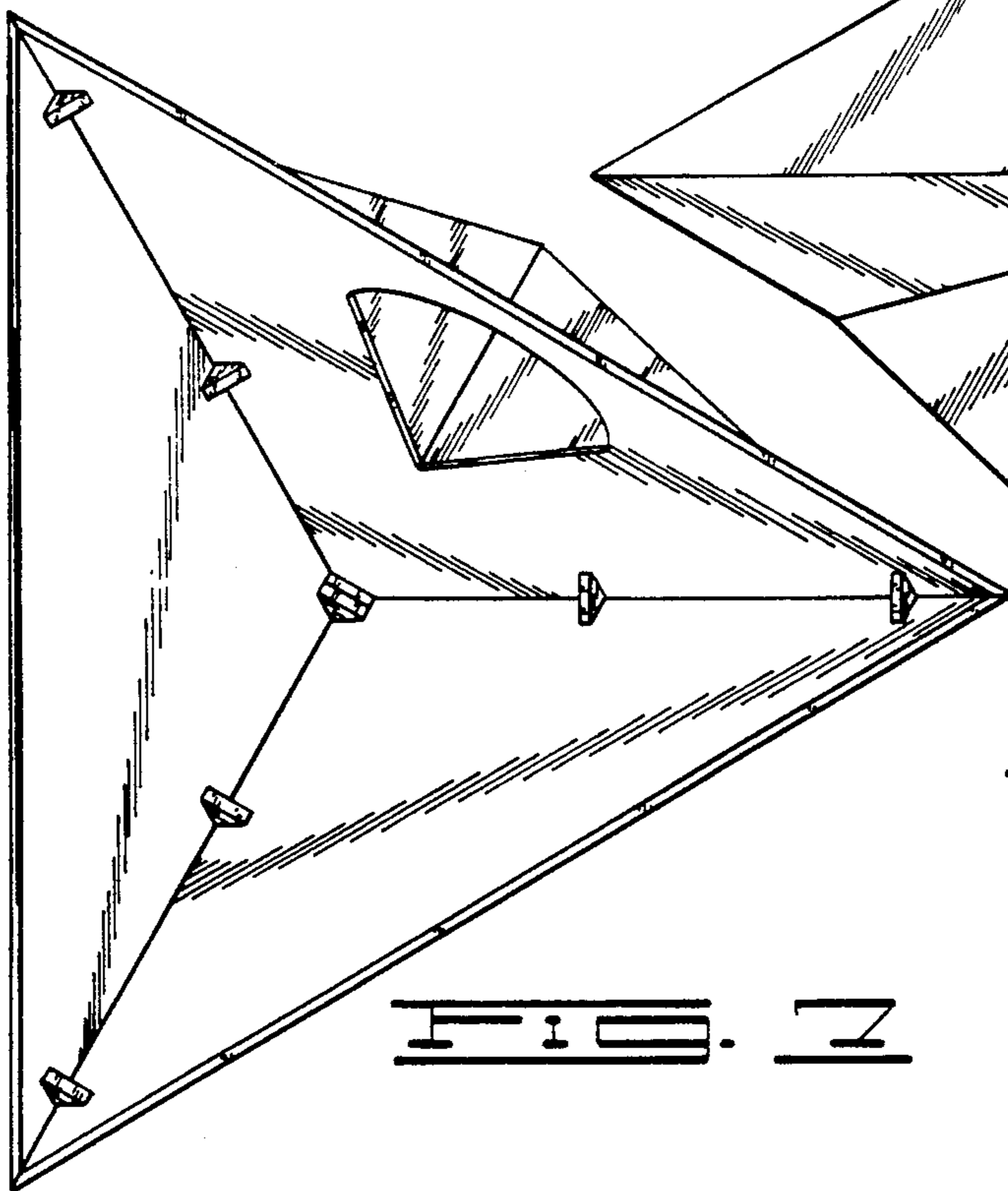

FIG. 7