



US00D326923S

United States Patent [19]

Yuen

[11] Patent Number: **Des. 326,923**

[45] Date of Patent: **** Jun. 9, 1992**

[54] RECHARGEABLE POWER FAILURE LIGHT

[75] Inventor: **John S. Yuen, Kowloon, Hong Kong**

[73] Assignee: **John Manufacturing Limited,
Kowloon, Hong Kong**

[**] Term: **14 Years**

[21] Appl. No.: **517,055**

[22] Filed: **May 1, 1990**

[30] **Foreign Application Priority Data**

Nov. 1, 1989 [GB]	United Kingdom	2002099
[52] U.S. Cl.		D26/26; D26/85
[58] Field of Search		D26/72, 80-92, D26/26; 362/362, 147, 432, 226

[56] **References Cited**

U.S. PATENT DOCUMENTS

D. 160,899	11/1950	Stevens	D26/87
D. 288,245	2/1987	Corder	D26/85 X
D. 288,857	3/1987	Spaine	D26/85
D. 301,750	6/1989	Fenne	D26/26

Primary Examiner—Susan J. Lucas
Attorney, Agent, or Firm—Fay, Sharpe, Beall, Fagan,
Minnich & McKee

[57] **CLAIM**

The ornamental design for a rechargeable power failure light, as shown and described.

DESCRIPTION

FIG. 1 is a front elevational view of a rechargeable power failure light showing my new design; FIG. 2 is a rear elevational view thereof; FIG. 3 is a left side elevational view thereof; FIG. 4 is a right side elevational view thereof; FIG. 5 is a top plan view thereof; and, FIG. 6 is an underneath plan view thereof.

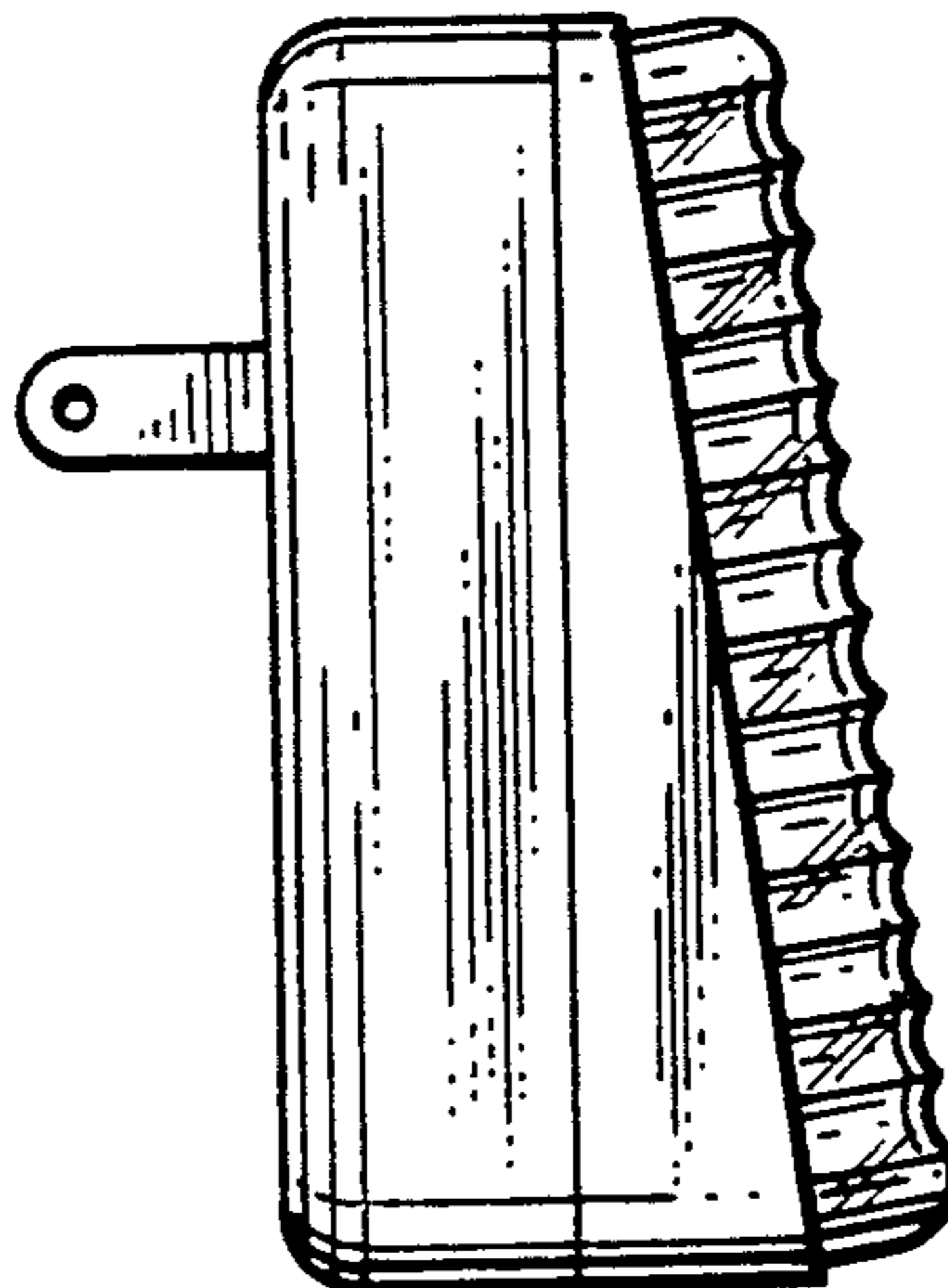
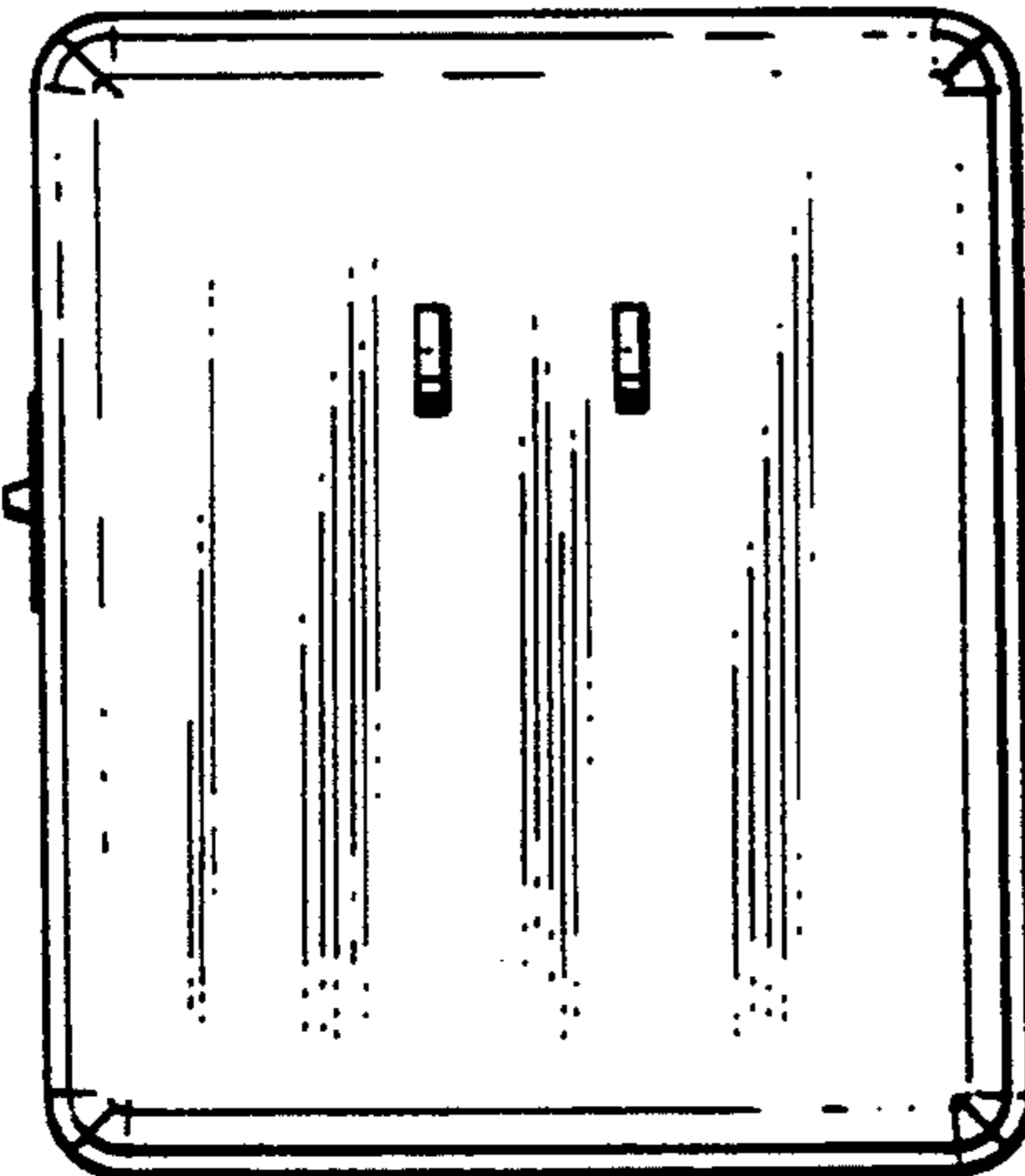
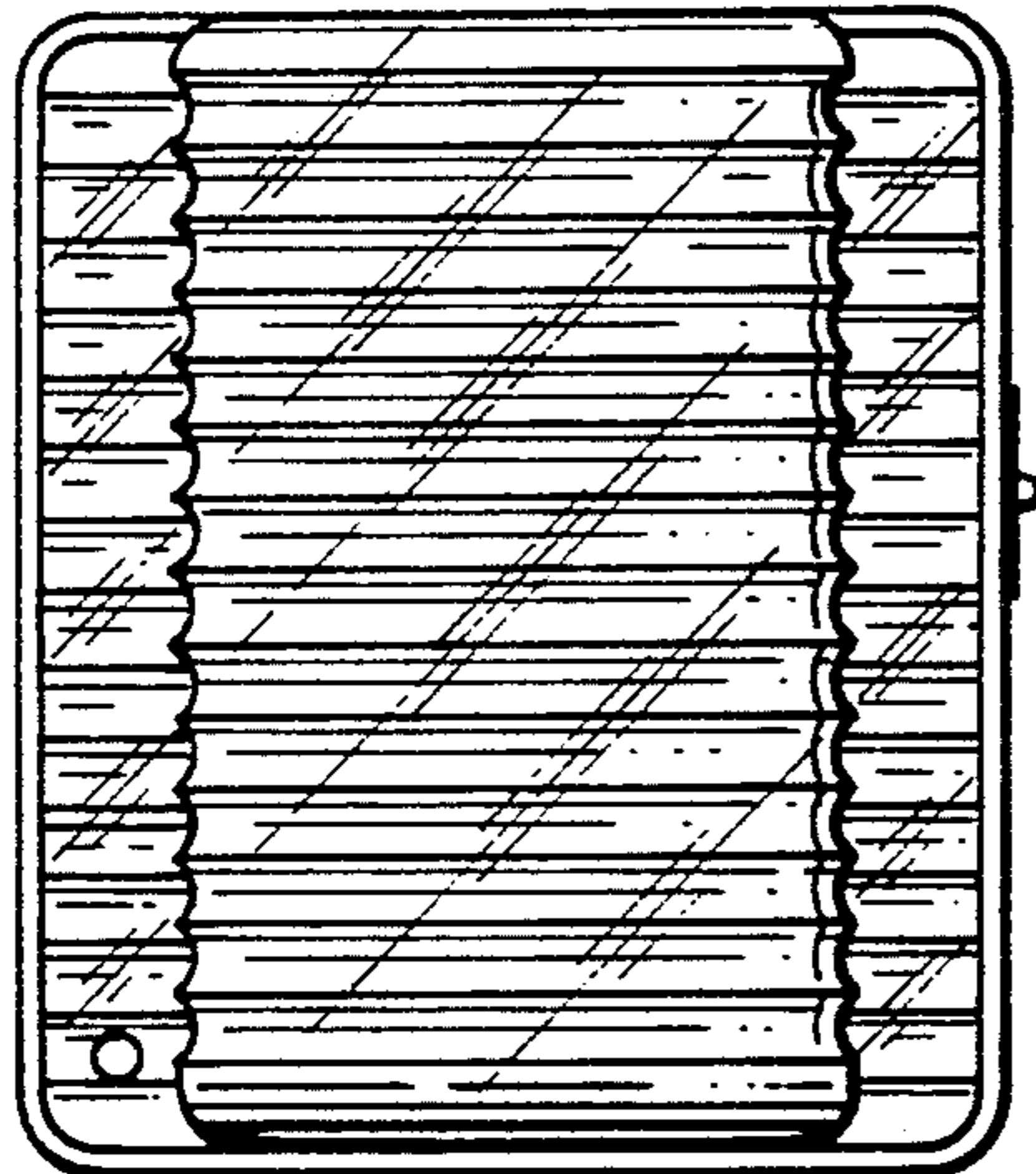

FIG. 1

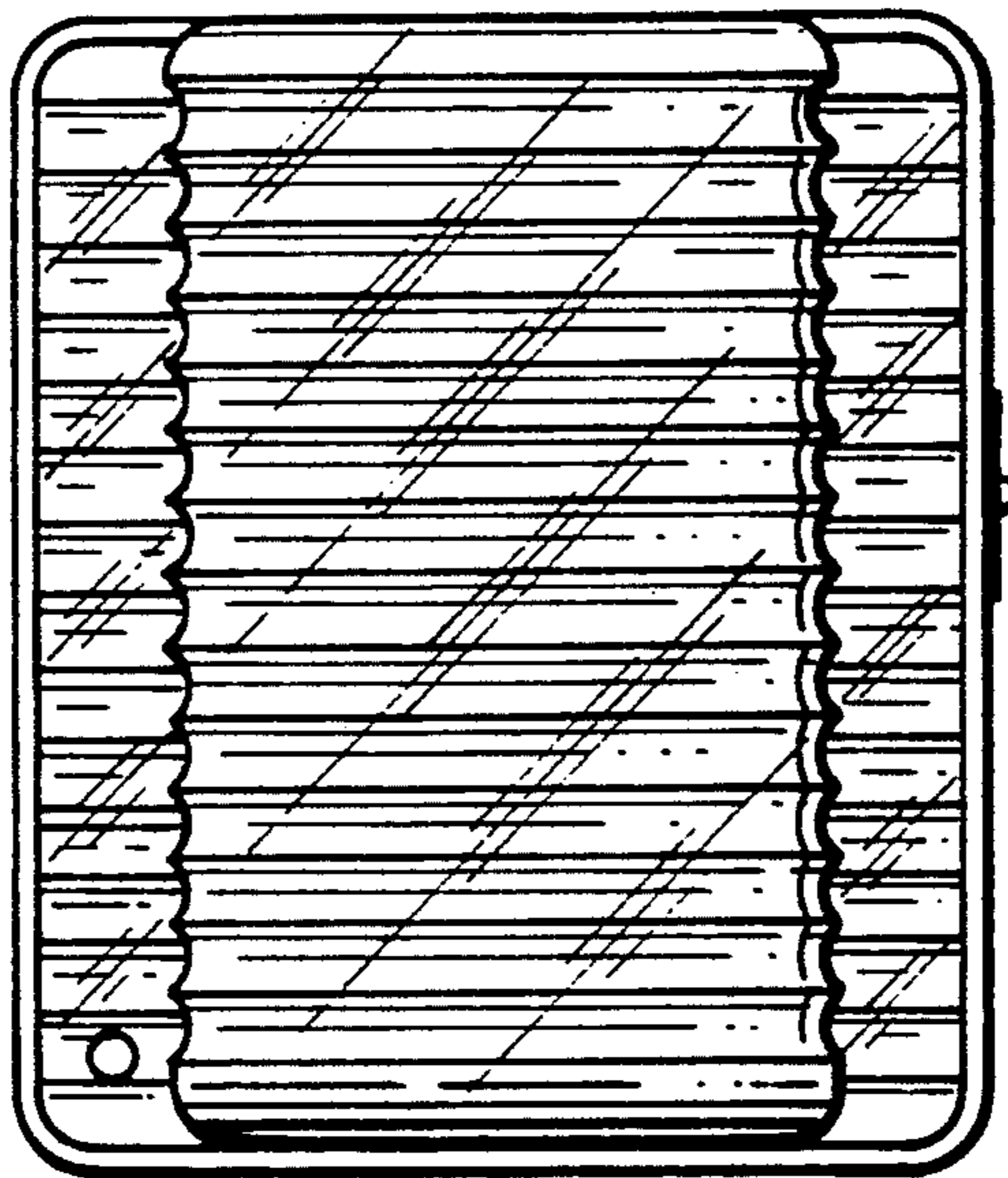

FIG. 2

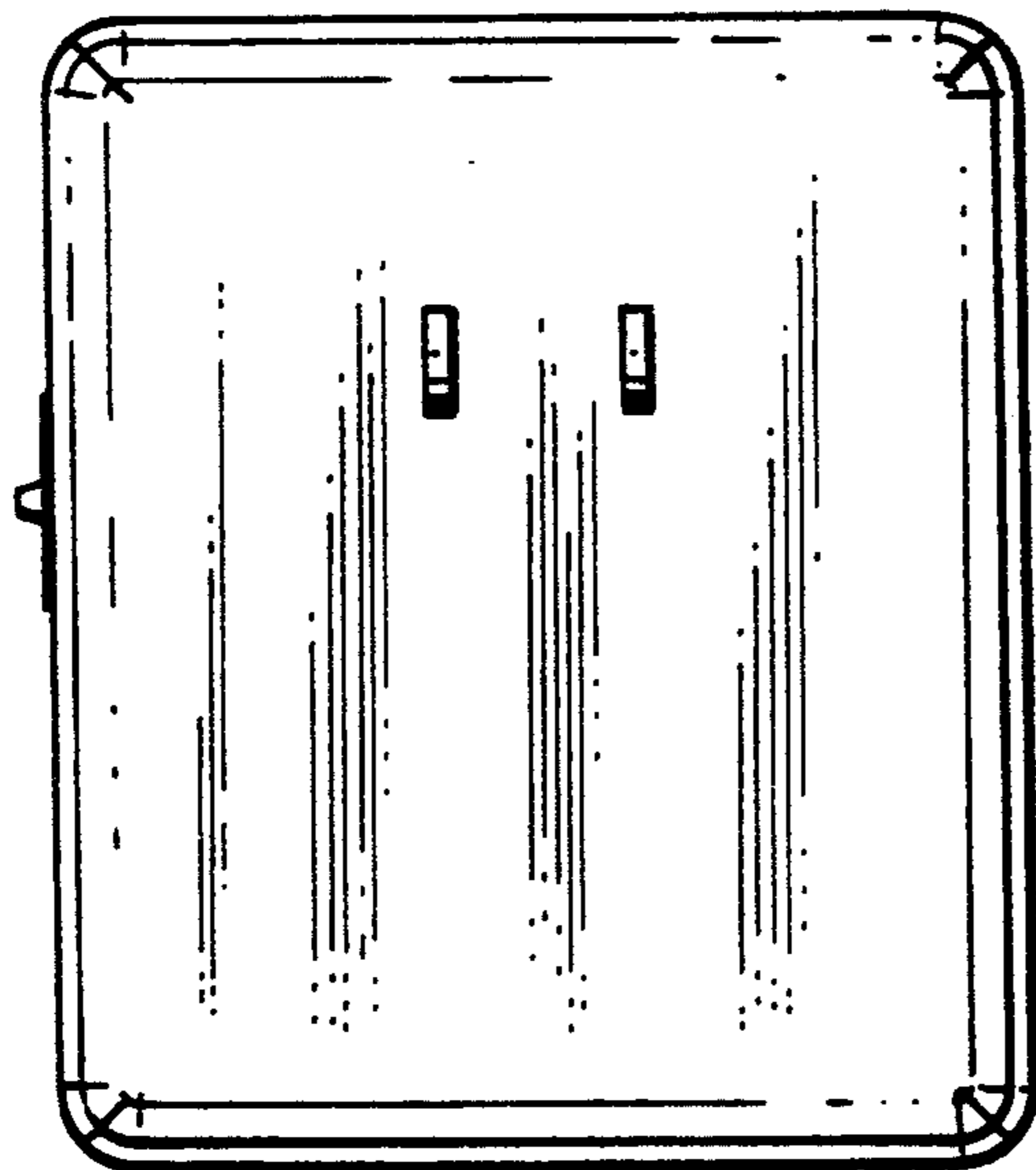

FIG. 3

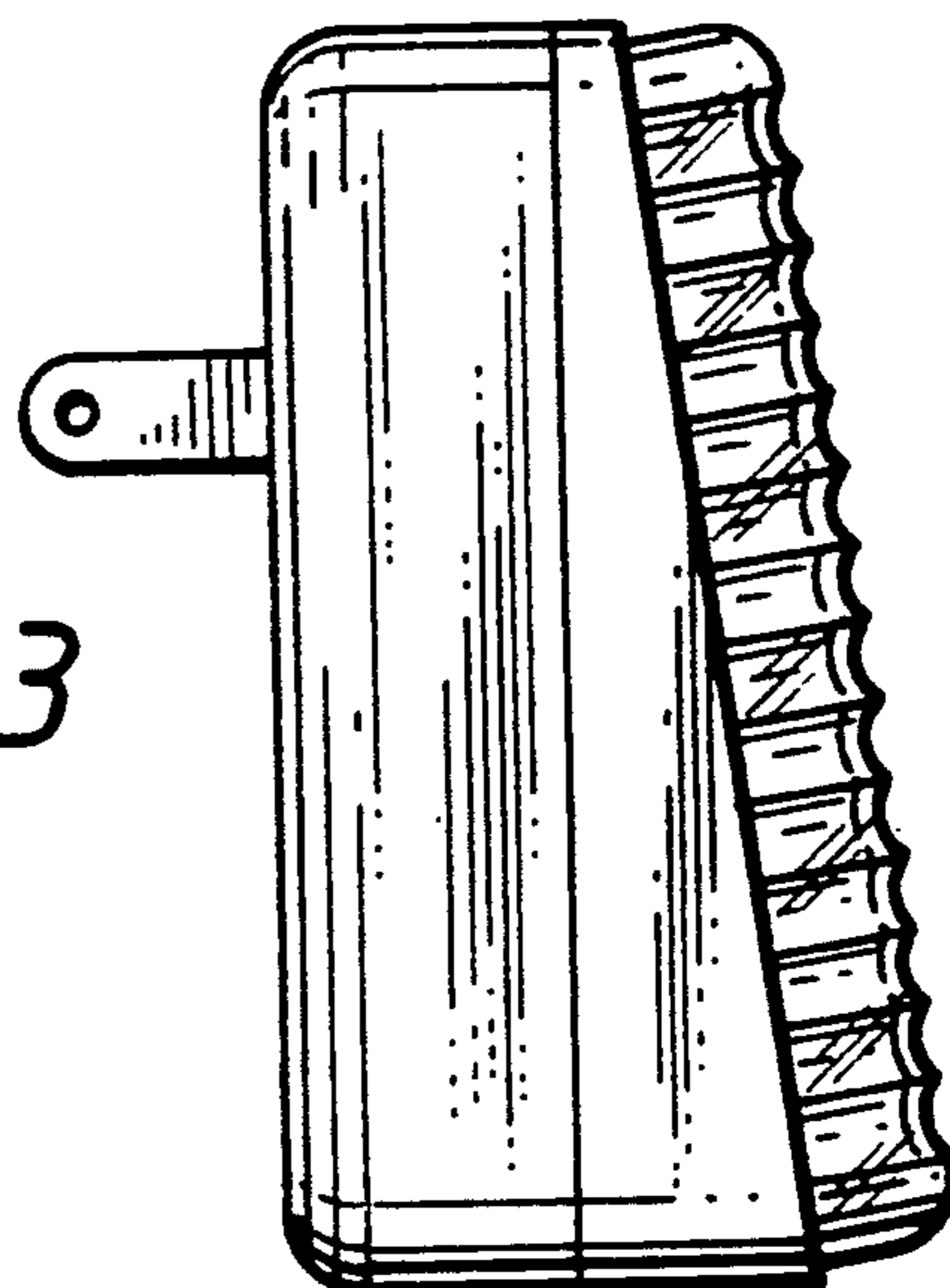

FIG. 4

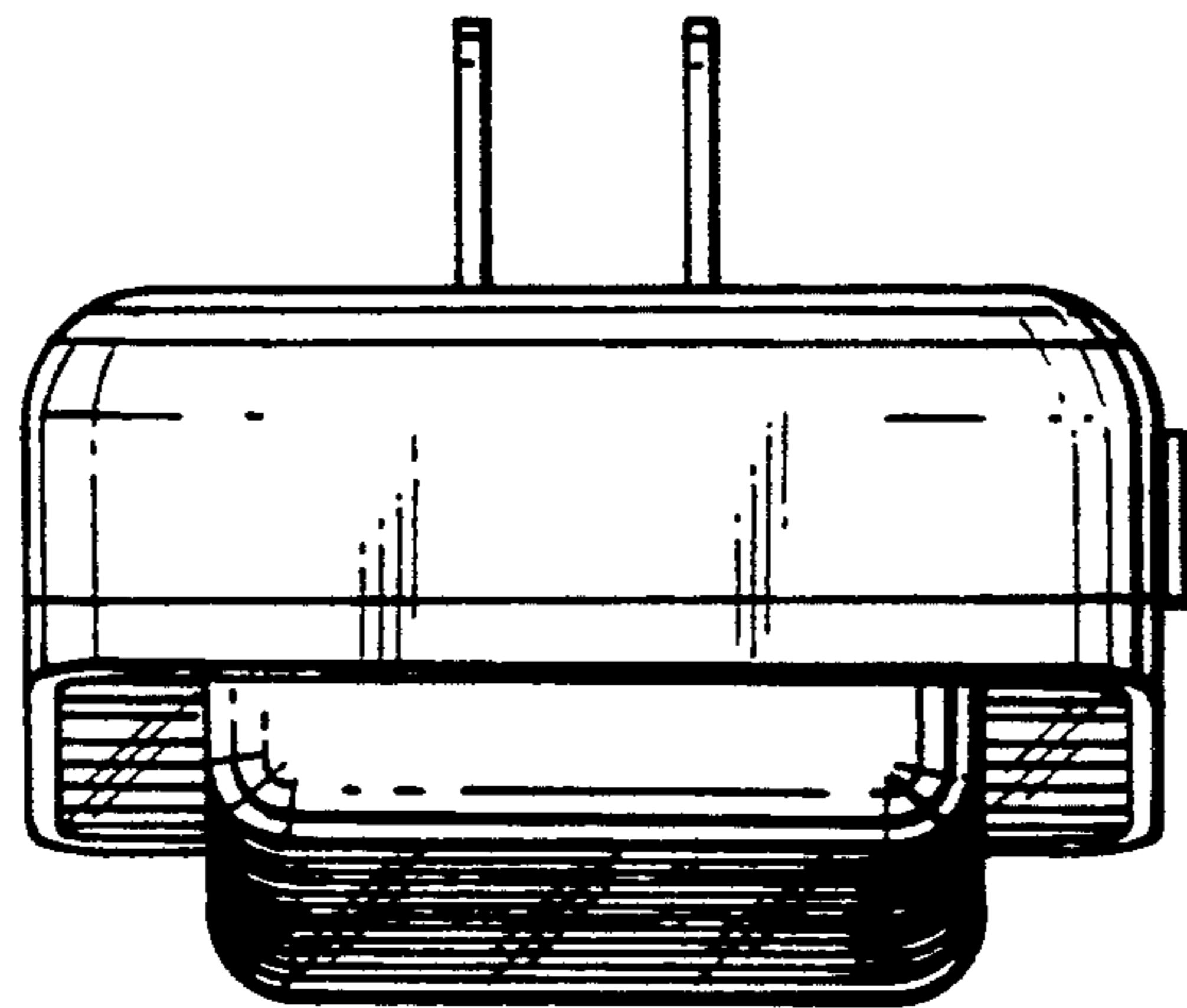
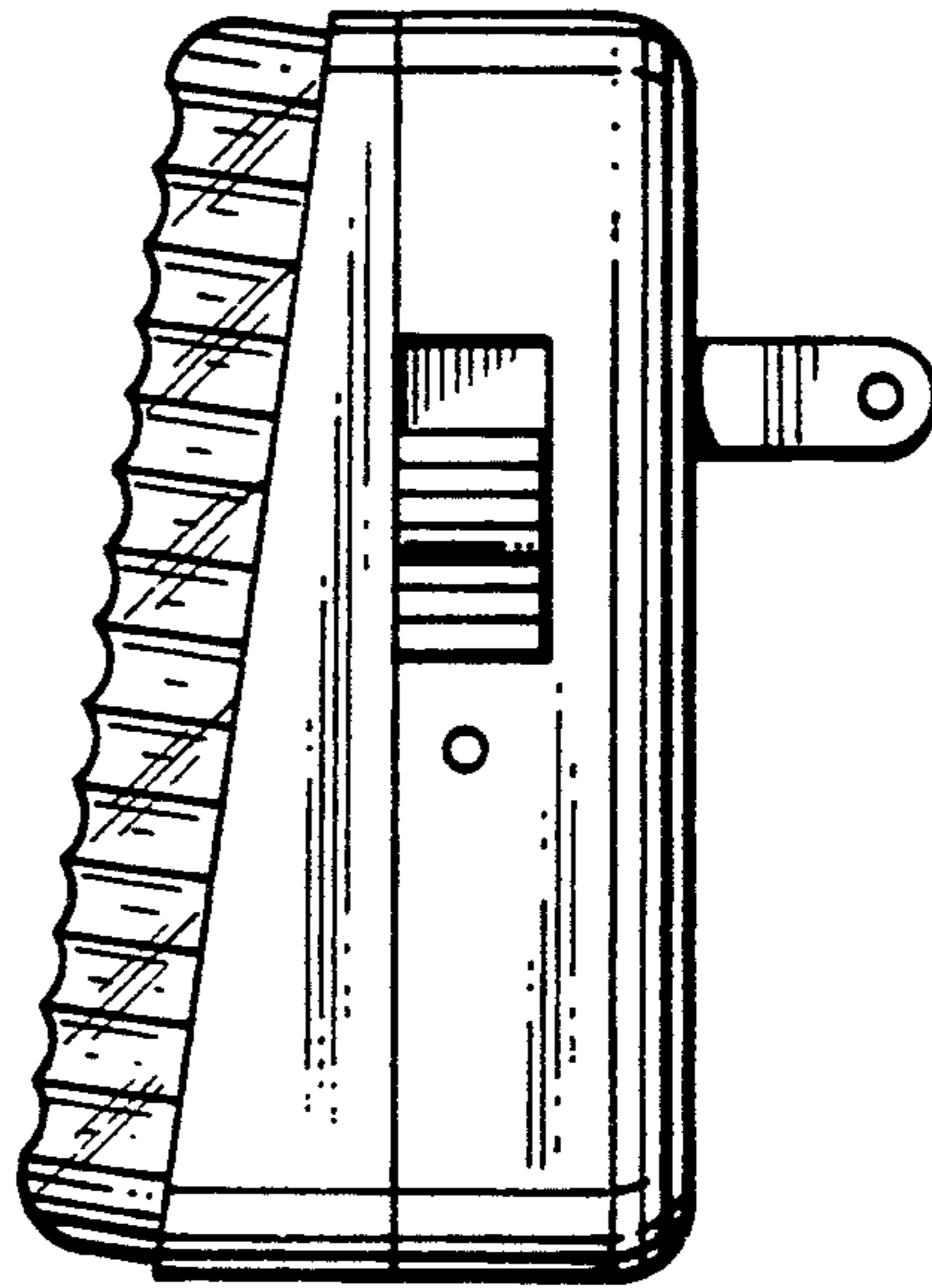

FIG. 5

FIG. 6

