



US00D326859S

United States Patent [19]

[11] Patent Number: Des. 326,859

Cody et al.

[45] Date of Patent: ** Jun. 9, 1992

[54] EXPANDABLE DIGGING BUCKET

[76] Inventors: **Rodney D. Cody**, 1236 W. Brandonwood Dr., Murray, Utah 84123; **William T. Finnegan**, 362 E. 9150 S., Sandy, Utah 84070

[**] Term: **14 Years**

[21] Appl. No.: **488,855**

[22] Filed: **Mar. 6, 1990**

[52] U.S. Cl. **D15/32; D15/28**

[58] Field of Search **D15/10, 11, 22, 23, D15/25, 28, 29, 32; 37/103, 117.5, 118 A, 118 R, 141 R, 141 T**

[56] References Cited

U.S. PATENT DOCUMENTS

D. 308,528	6/1990	Harr	D15/32
3,750,816	8/1973	Becker	37/118 R
4,037,337	7/1977	Hemphill	37/141 R
4,081,919	4/1978	Teach	.	
4,208,814	6/1980	Stone	.	
4,633,601	1/1987	Fleck et al.	D15/28
4,691,455	9/1987	Newman	.	

OTHER PUBLICATIONS

Agricultural Machinery Journal Dec. 1975 p. 80 "Harford Excavator Bucket".

Primary Examiner—Bernard Ansher
Assistant Examiner—Sandra Morris
Attorney, Agent, or Firm—Terry M. Gernstein

[57] CLAIM

The ornamental design for an expandable digging bucket, as shown and described.

DESCRIPTION

FIG. 1 is a perspective view of an expandable digging bucket showing our new design; FIG. 2 is a front elevational view thereof; FIG. 3 is a left side elevational view thereof; FIG. 4 is a right side elevational view thereof; FIG. 5 is a top plan view thereof; FIG. 6 is a rear elevational view thereof; FIG. 7 is a perspective view of a second embodiment; FIG. 8 is a front elevational view of FIG. 7; FIG. 9 is a right side elevational view of FIG. 7; FIG. 10 is a left side elevational view of FIG. 7; FIG. 11 is a top plan view of FIG. 7; and, FIG. 12 is a bottom plan view of FIG. 7.

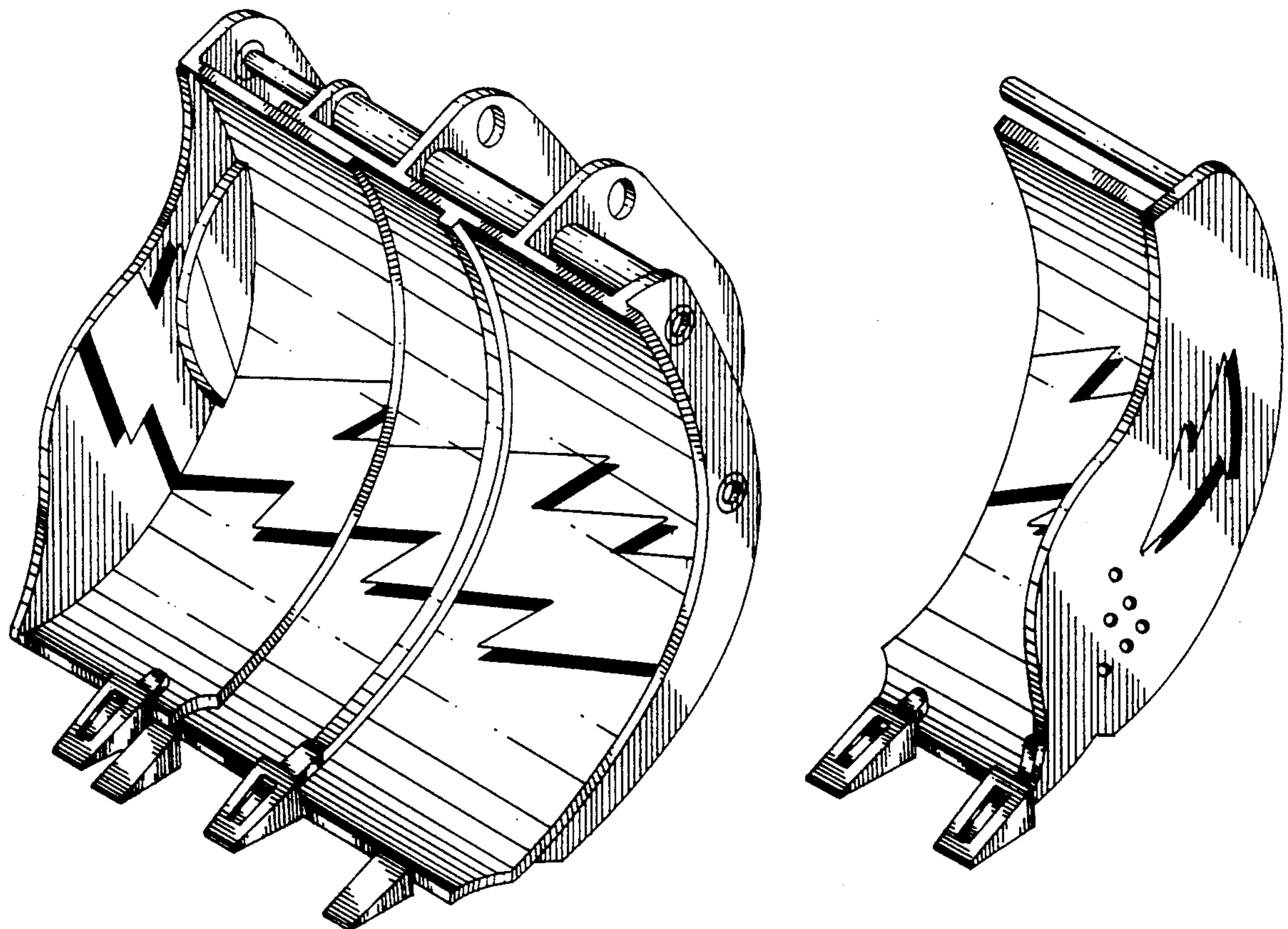

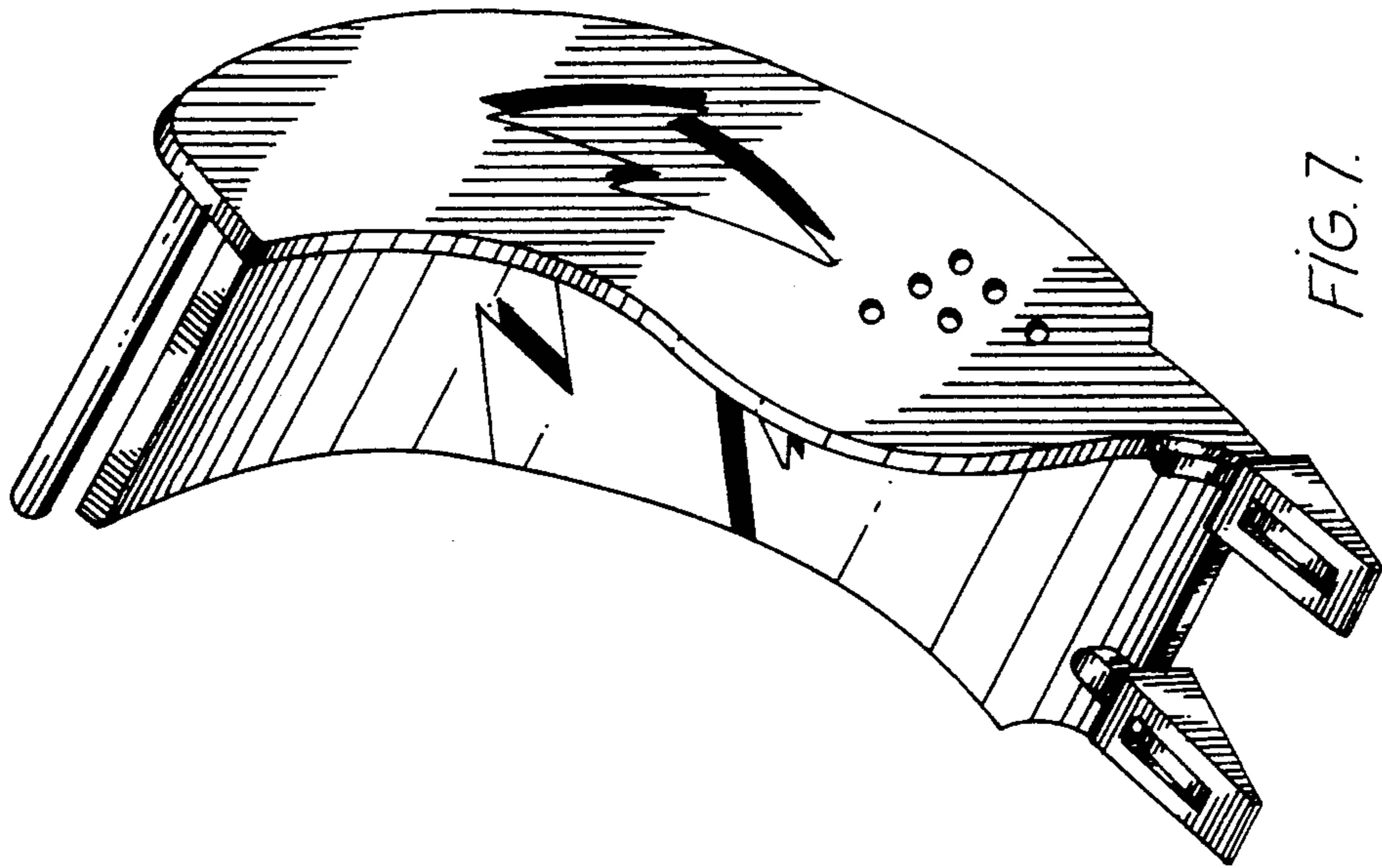

FIG. 7.

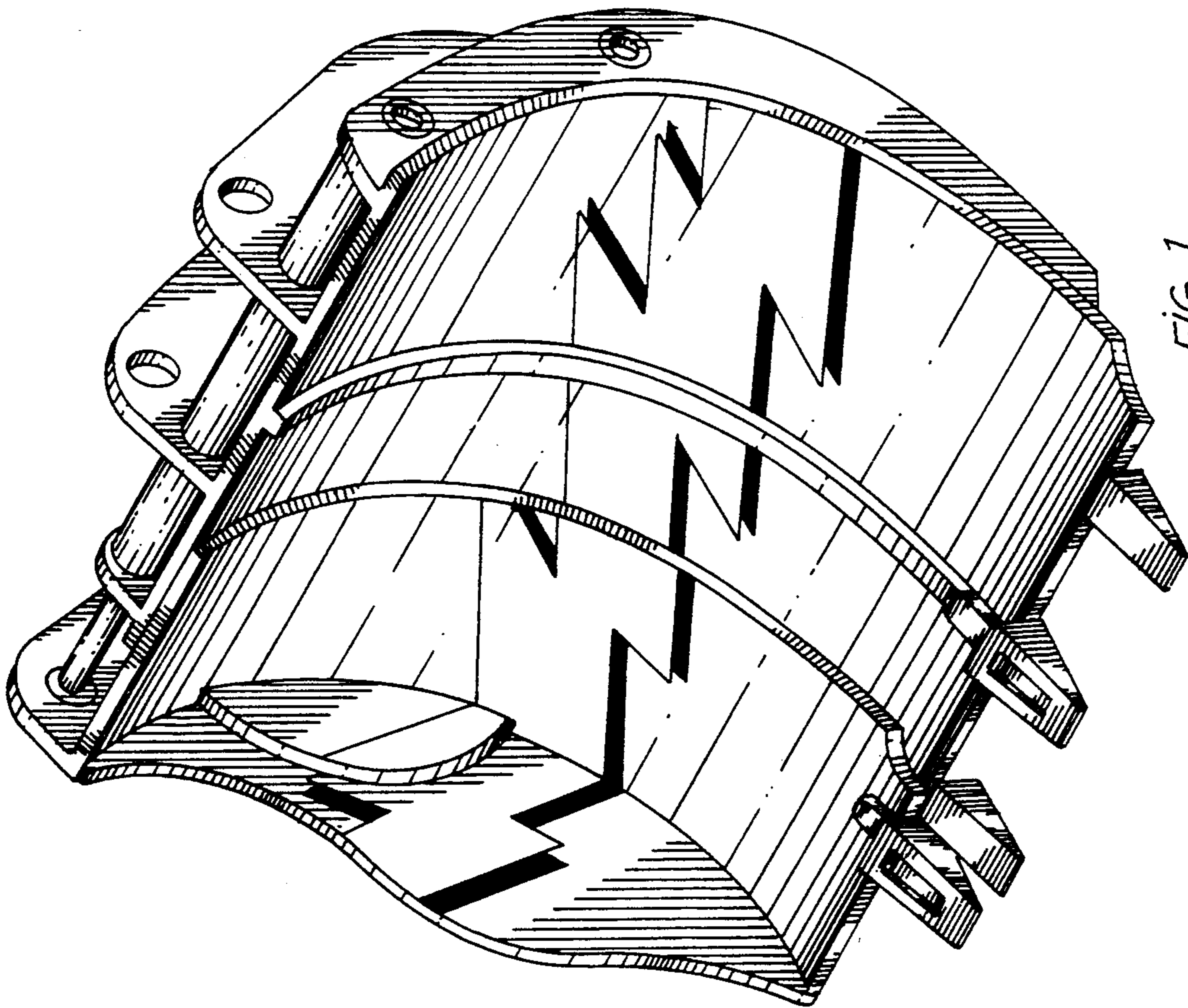

FIG. 1.

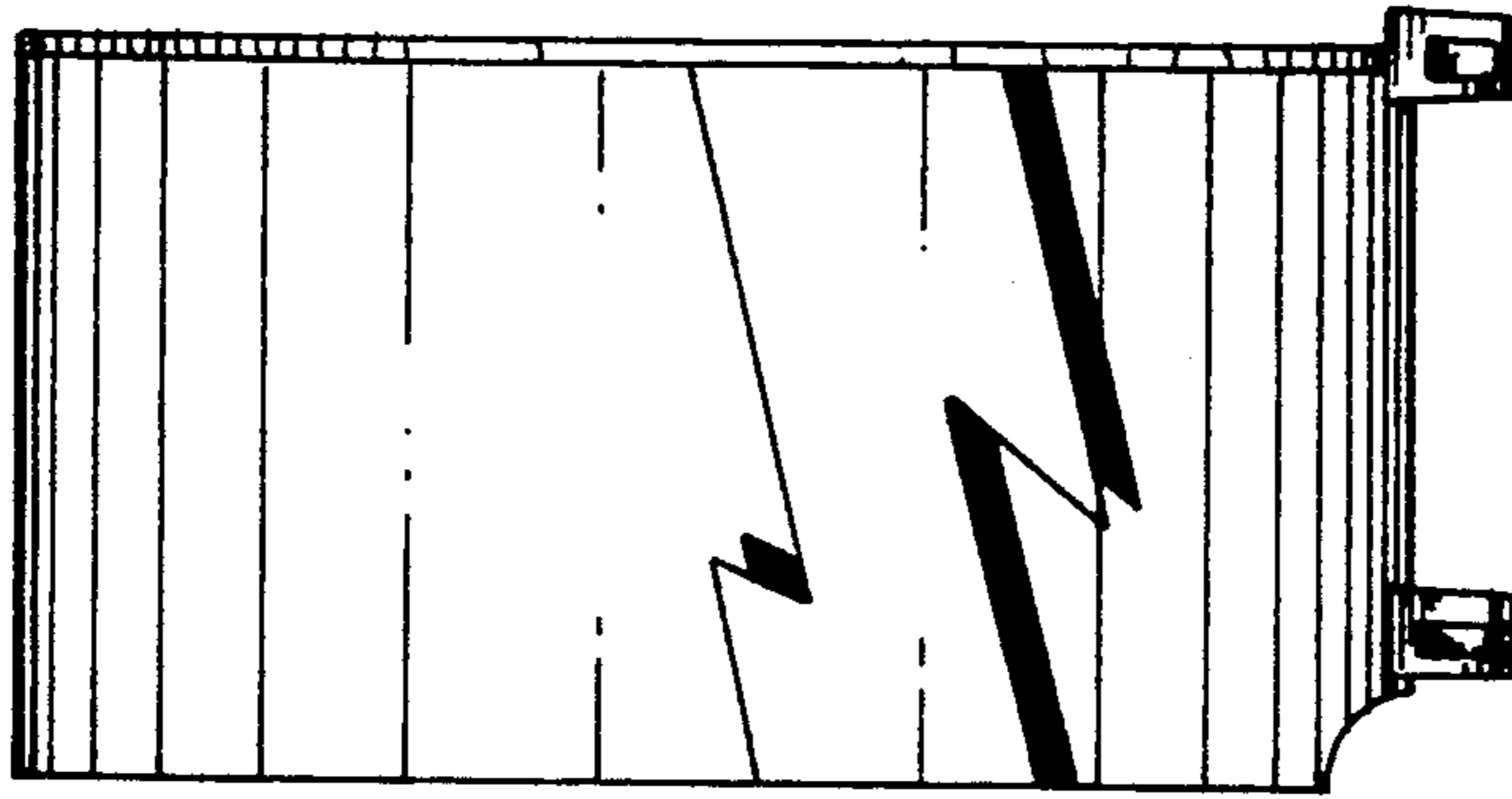

FIG. 8

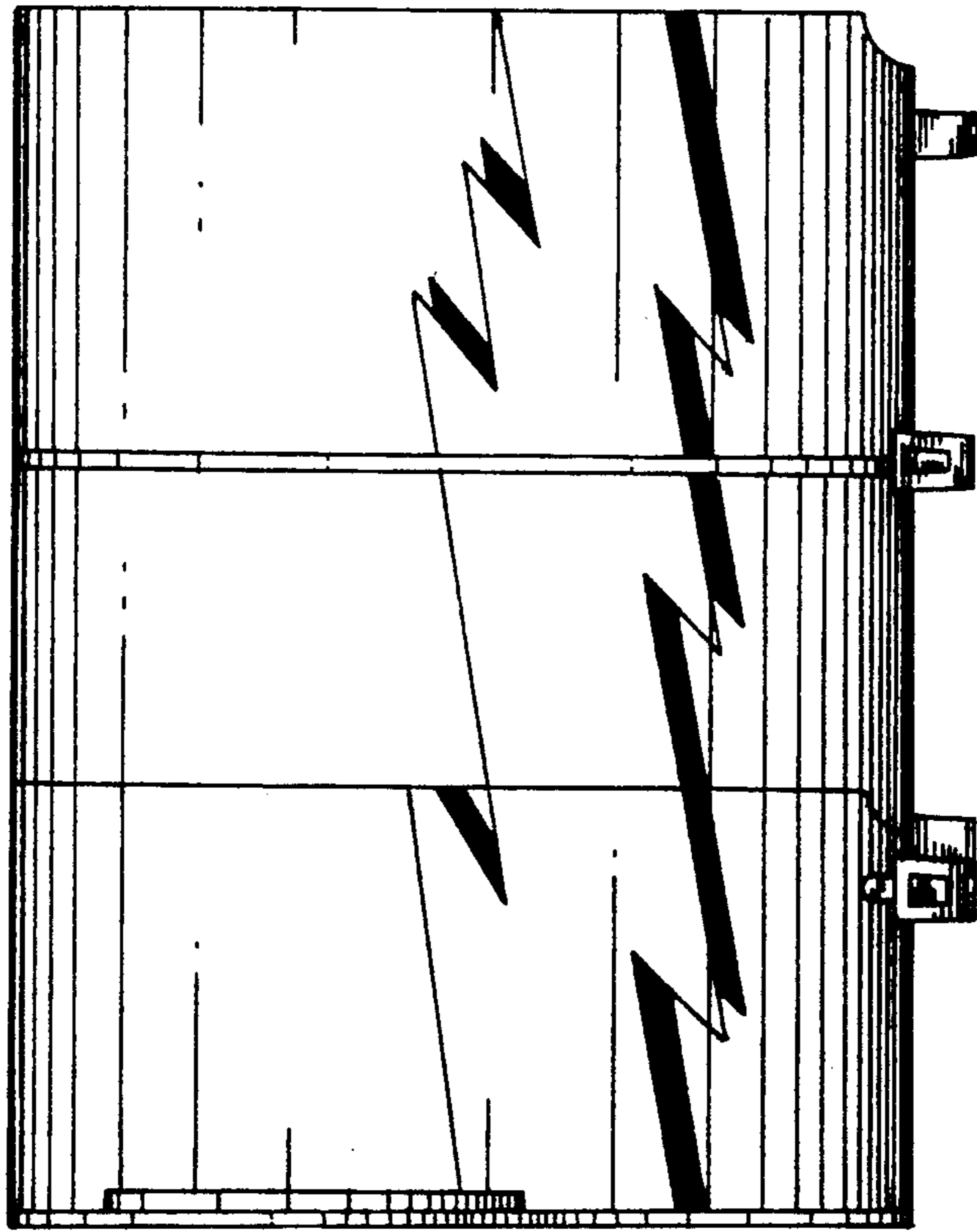

FIG. 2.

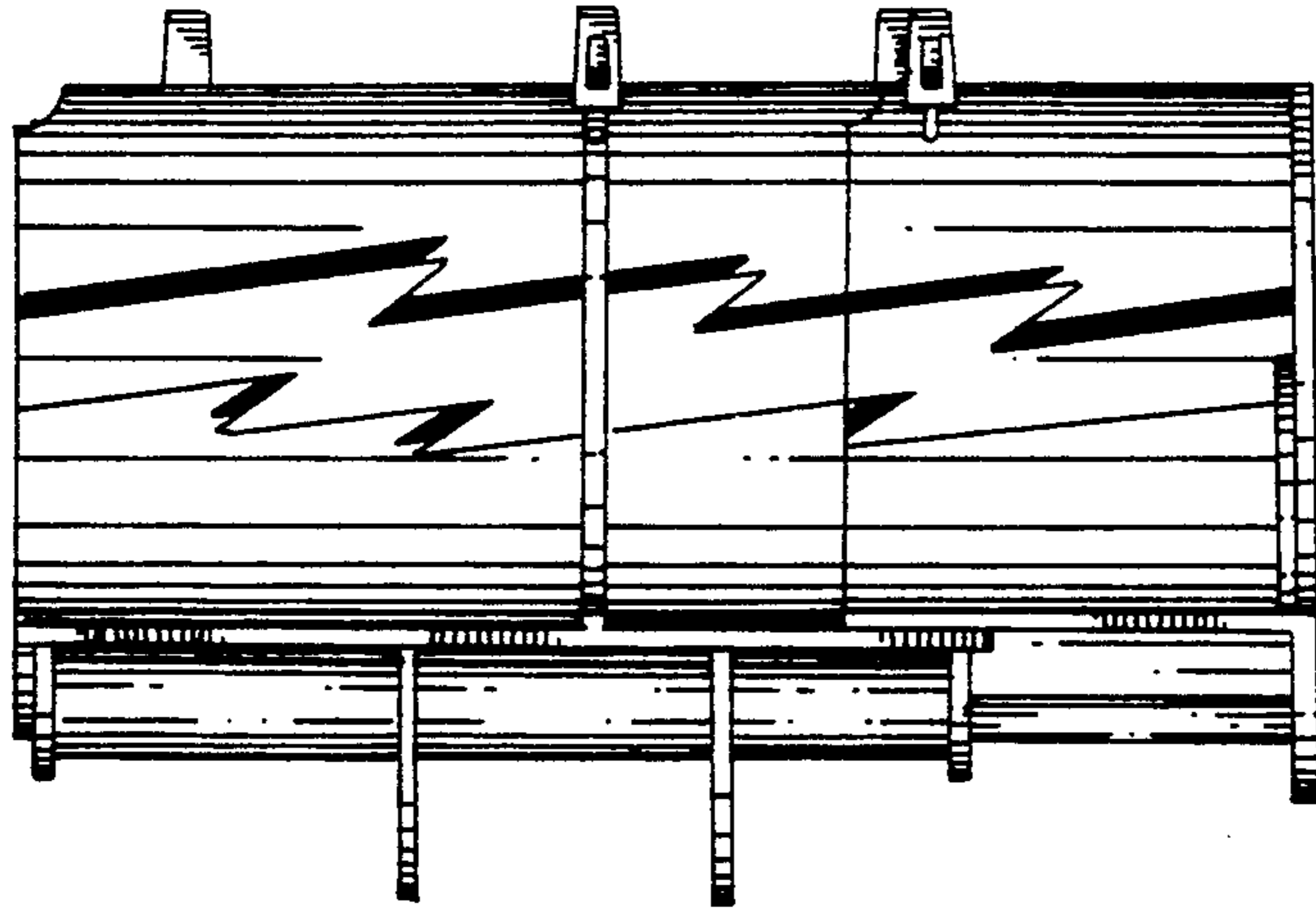

FIG. 5.

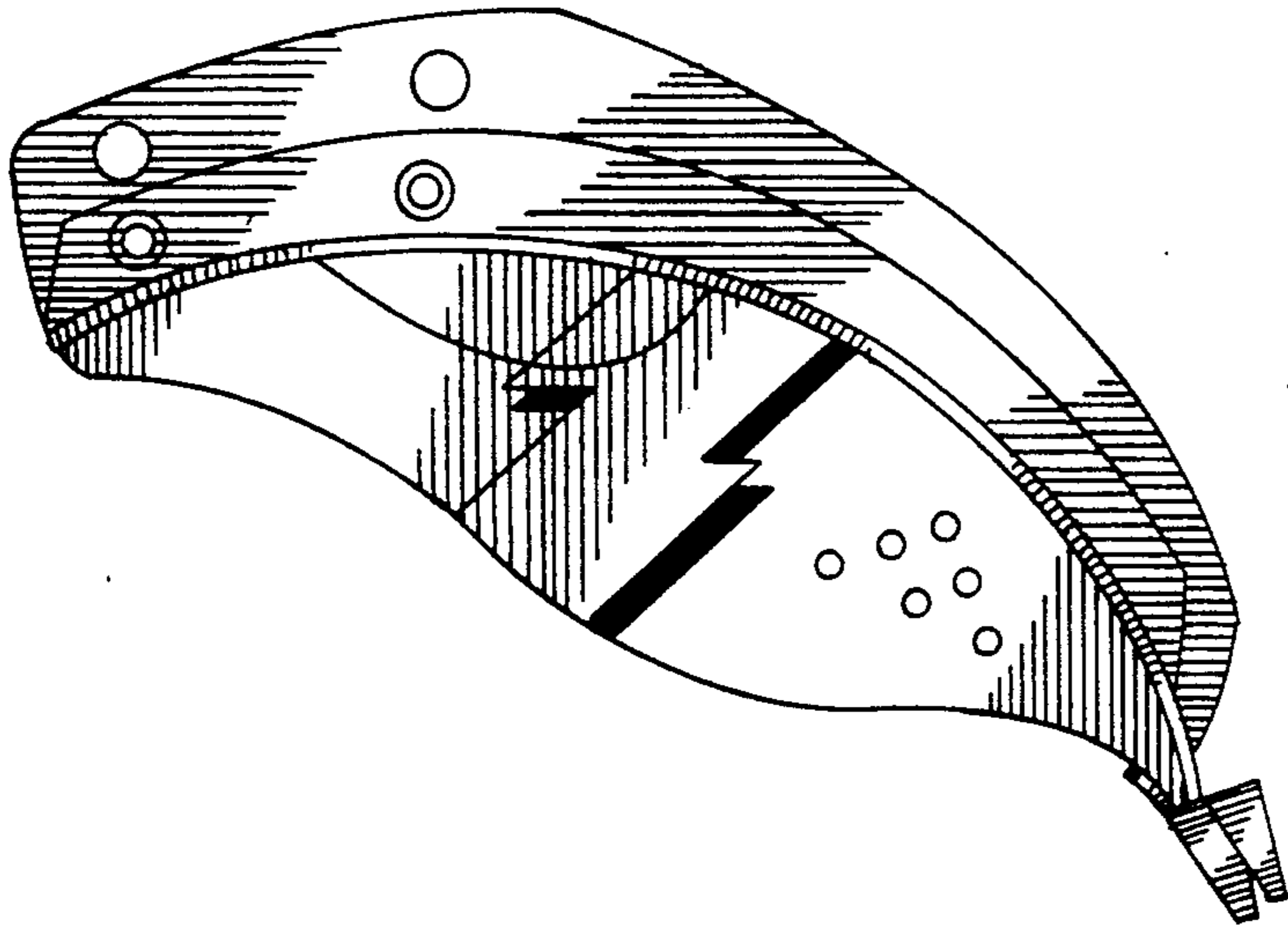

FIG. 4.

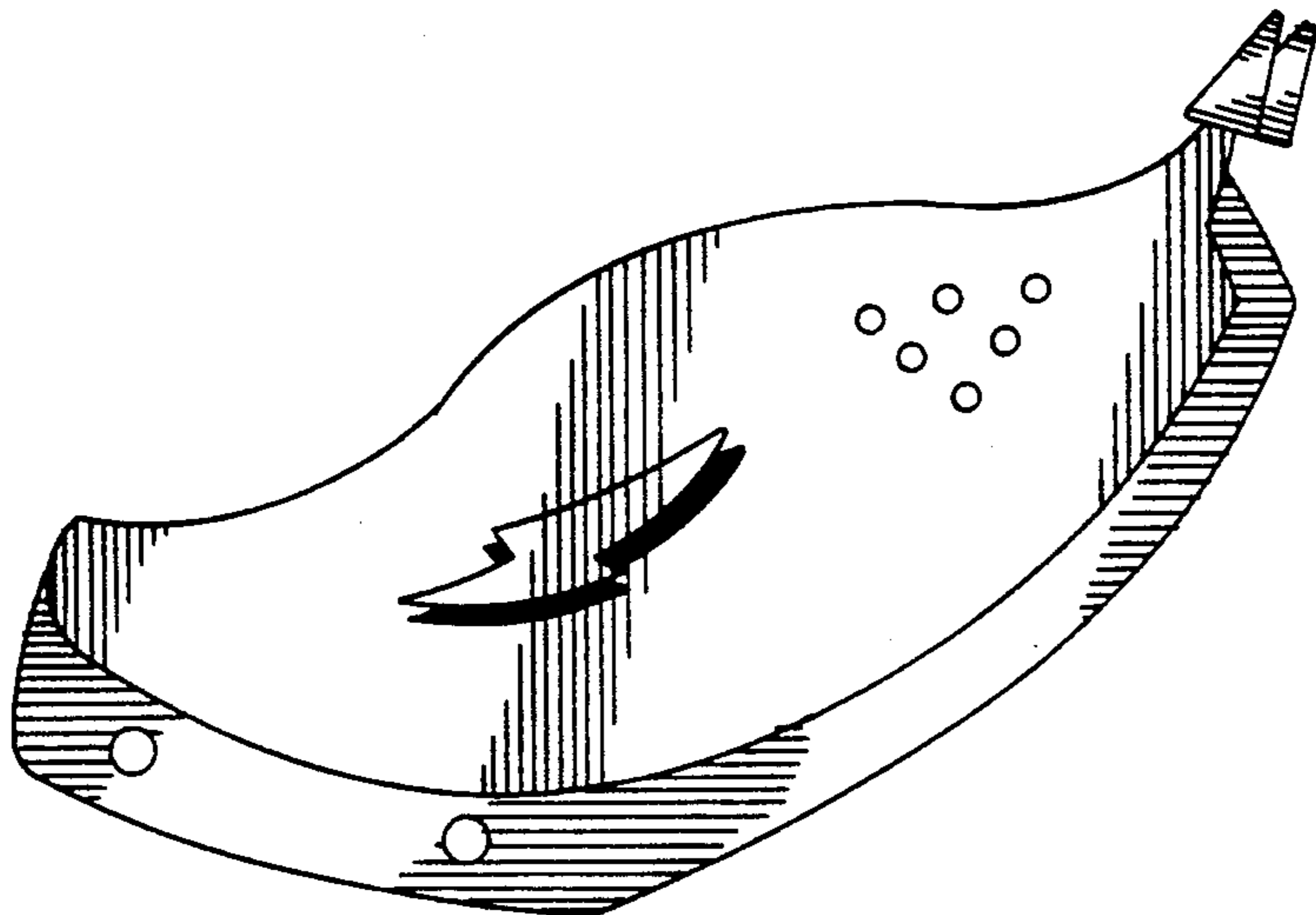

FIG. 3.

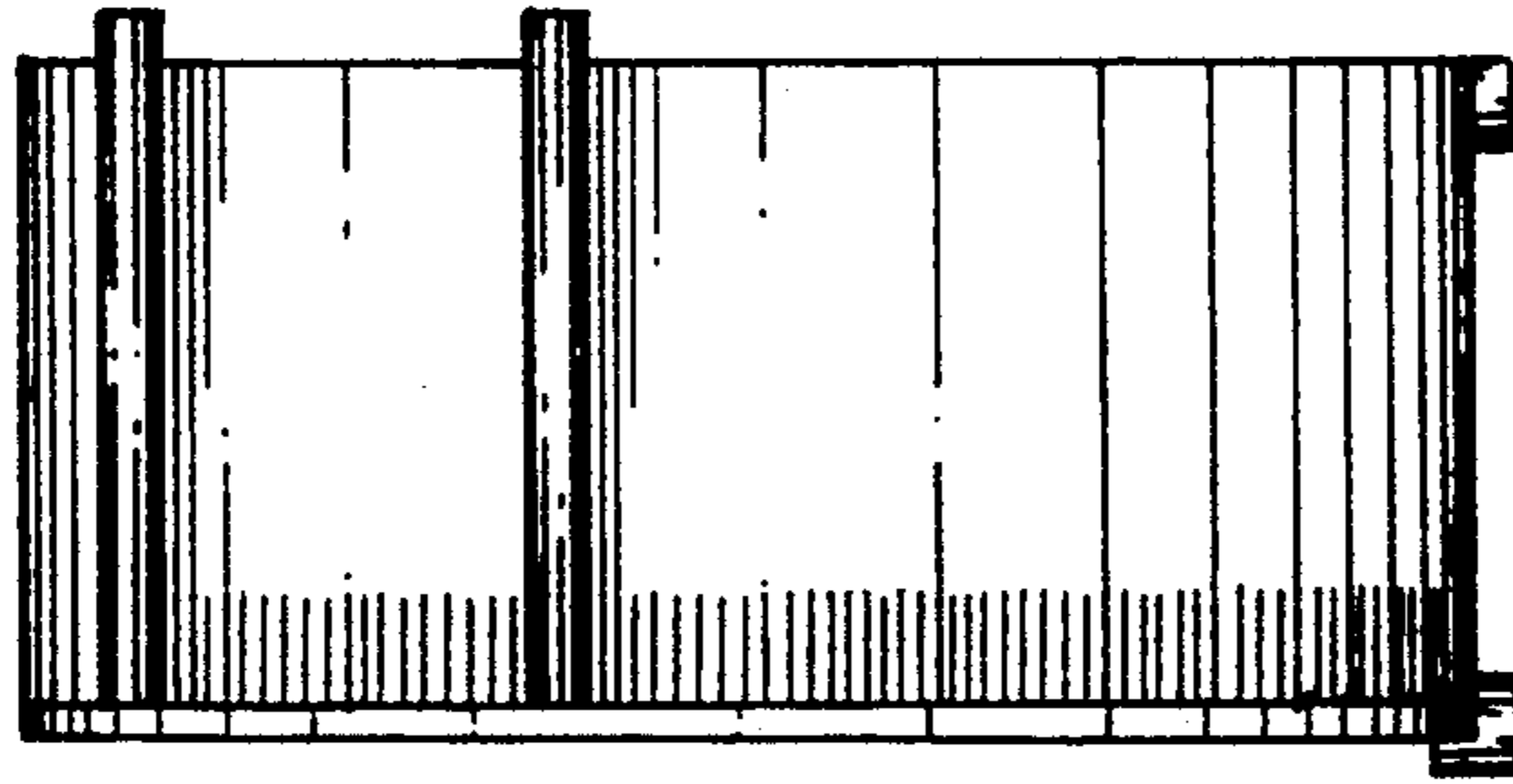

FIG. 12.

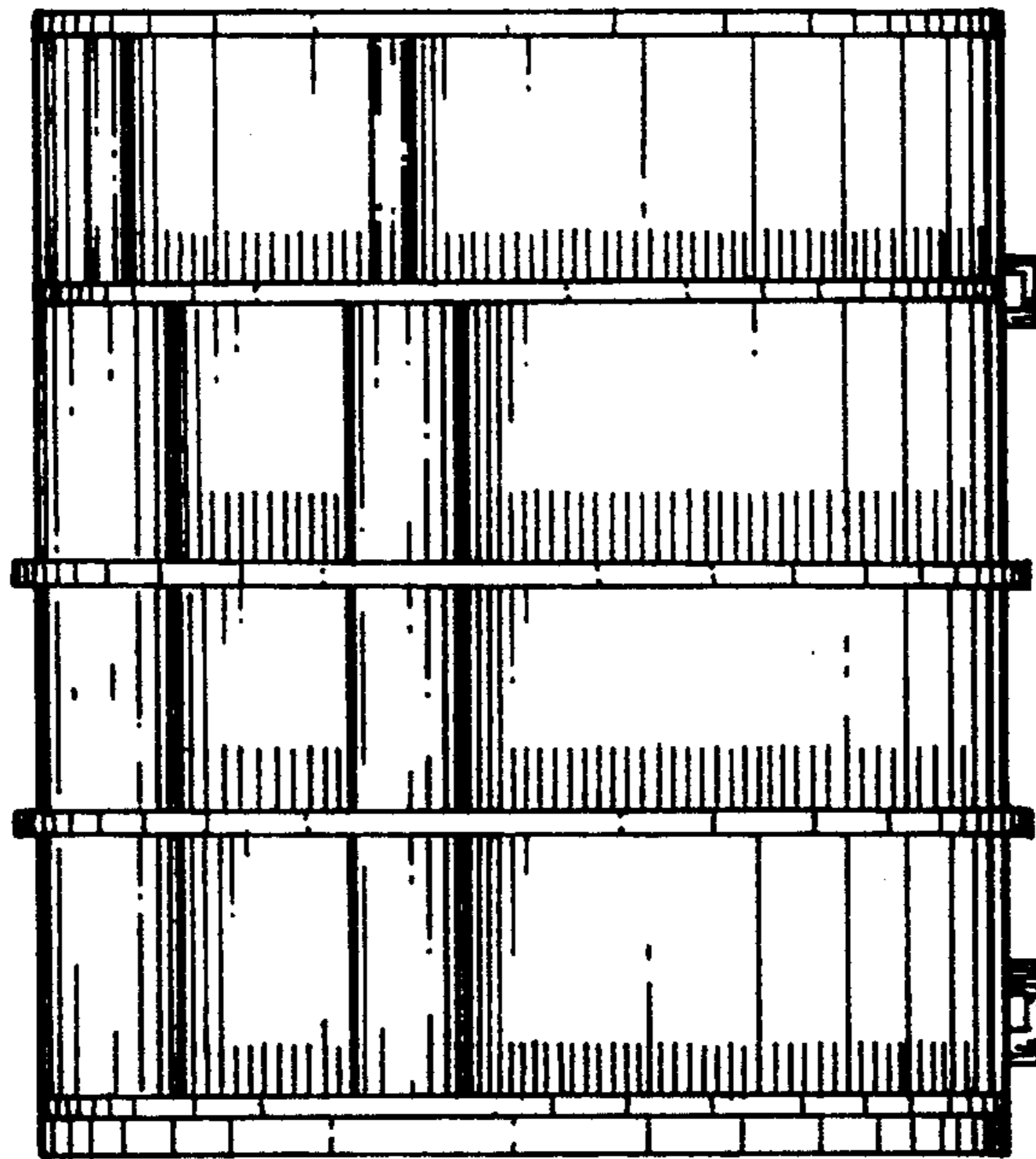

FIG. 6.

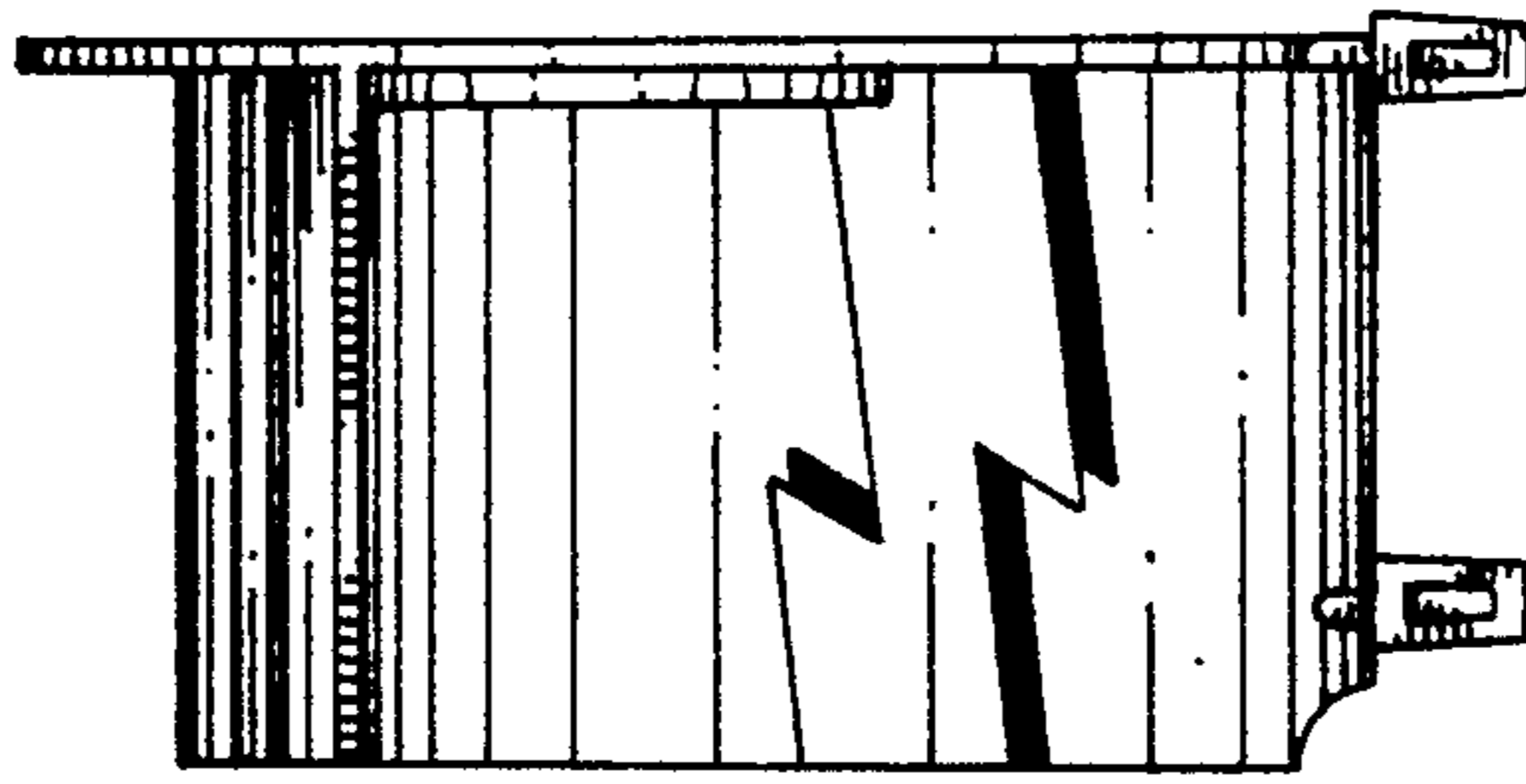

FIG. 11.

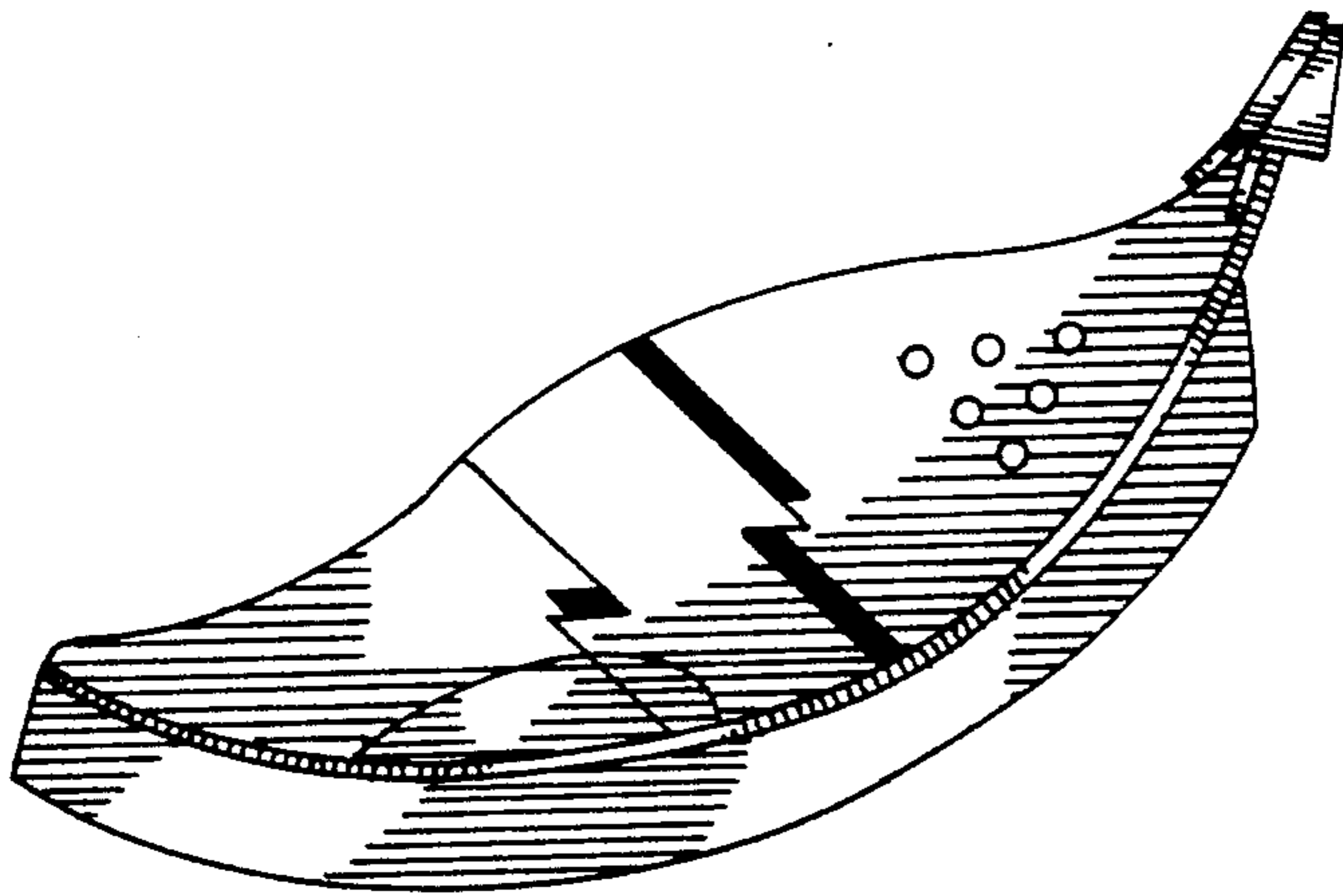

FIG. 10.

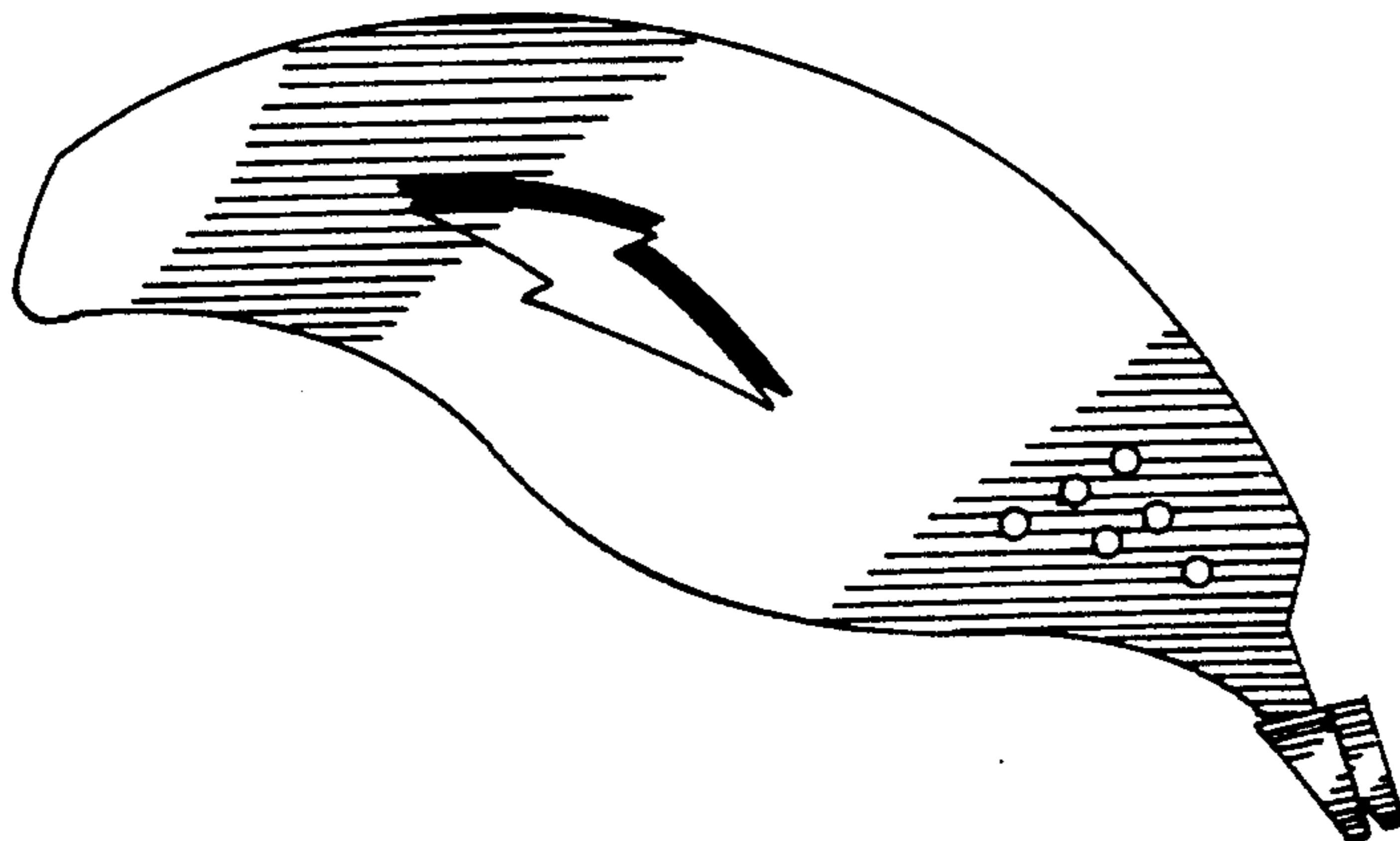

FIG. 9.