



US00D326841S

# United States Patent [19]

[11] Patent Number: **Des. 326,841**

Hopper et al.

[45] Date of Patent: **\*\* Jun. 9, 1992**

[54] BOAT

4,492.176 1/1985 Arima ..... 114/271

[75] Inventors: **Randy W. Hopper**, Flippin; **Charles C. Hoover**, Bull Shoals; **Dale H. Jensen**, Everton; **Kenneth P. Poley**, Yellville, all of Ark.

### OTHER PUBLICATIONS

Trailer Boats, Jun. 1983, p. 20, "Century Skier-CTS".  
Glastrom Boat Co. Brochure, Cat. 2040, ©1979,  
"HP154".

[73] Assignee: **Wood Manufacturing Company, Inc.**,  
Flippin, Ark.

*Primary Examiner*—Kay H. Chin  
*Attorney, Agent, or Firm*—Colton & Stone, Inc.

[\*\*] Term: **14 Years**

### [57] CLAIM

[21] Appl. No.: **521,657**

The ornamental design for a boat, as shown and described.

[22] Filed: **May 10, 1990**

### DESCRIPTION

[52] U.S. Cl. .... **D12/314; D12/311**

[58] Field of Search ..... **D12/300, 311, 310, 312,**  
**D12/313, 314, 315, 318; 114/271, 56, 57, 290,**  
**291**

FIG. 1 is a top plan view of the boat showing our new design;  
FIG. 2 is an elevational view of the left side thereof, the right side being a mirror image of the left side;  
FIG. 3 is a bottom plan view thereof;  
FIG. 4 is a front elevational view thereof;  
FIG. 5 is a rear elevational view thereof; and,  
FIG. 6 is a top perspective view thereof.

### [56] References Cited

#### U.S. PATENT DOCUMENTS

D. 252,507 7/1979 Wood ..... D12/311

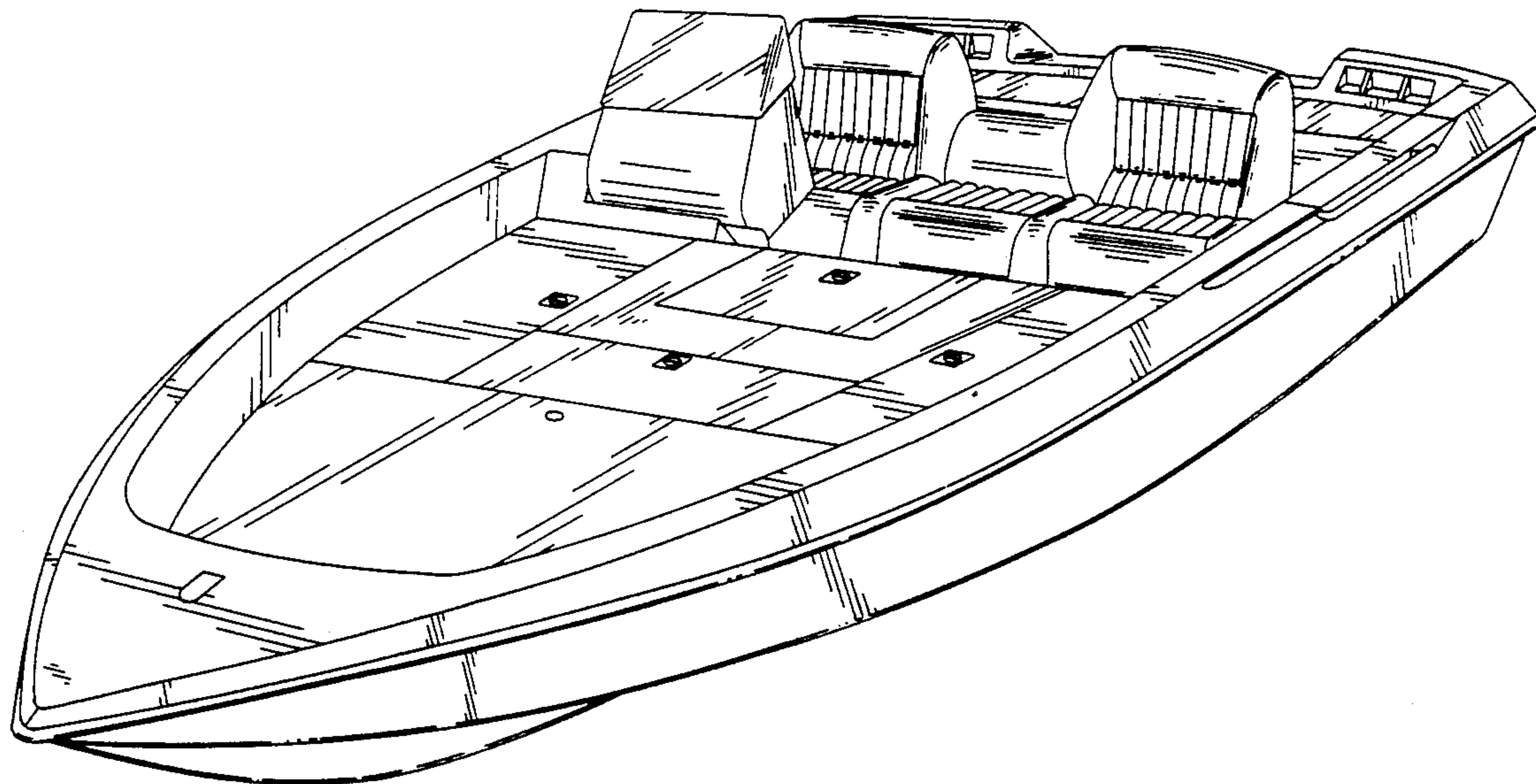

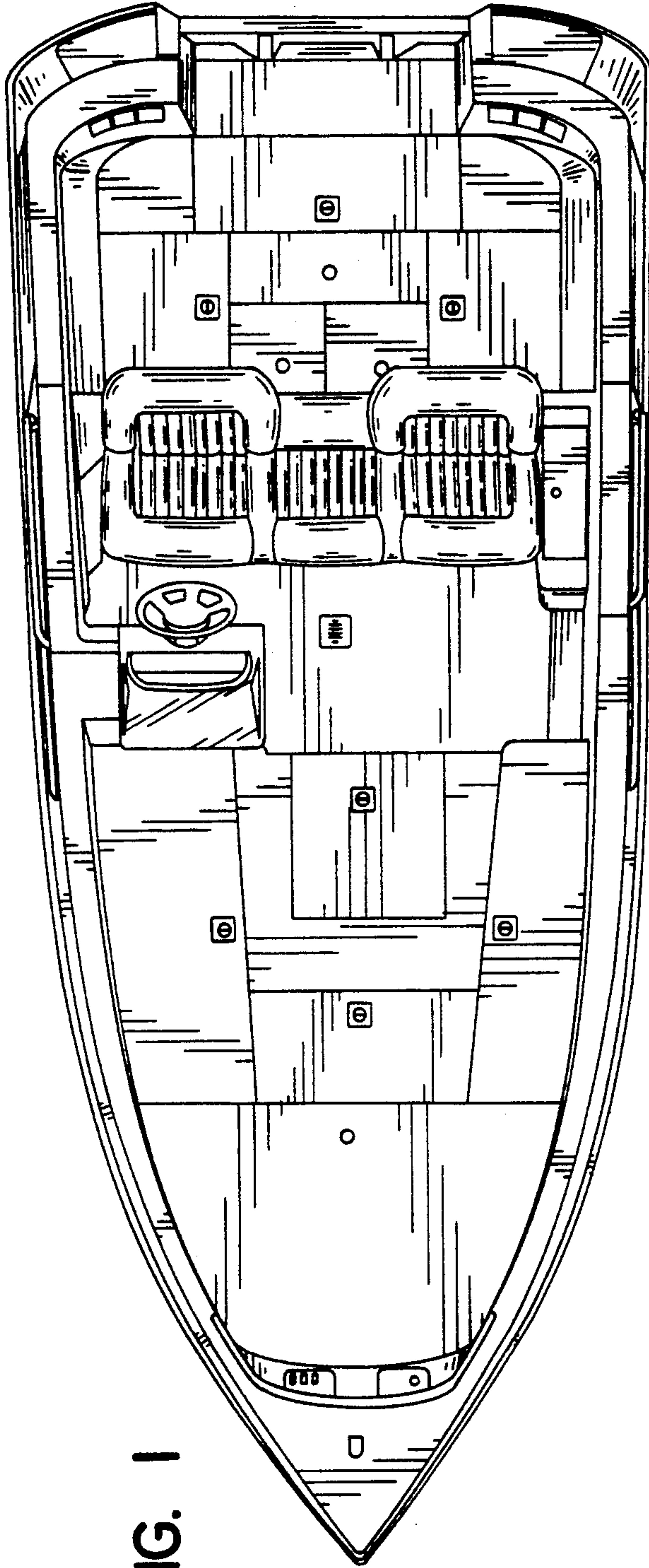

FIG. 1

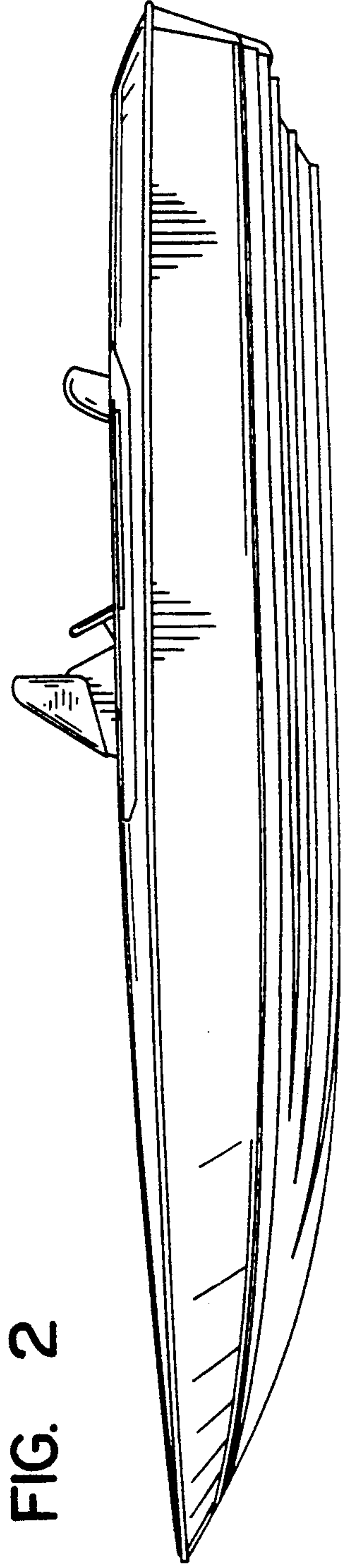

FIG. 2

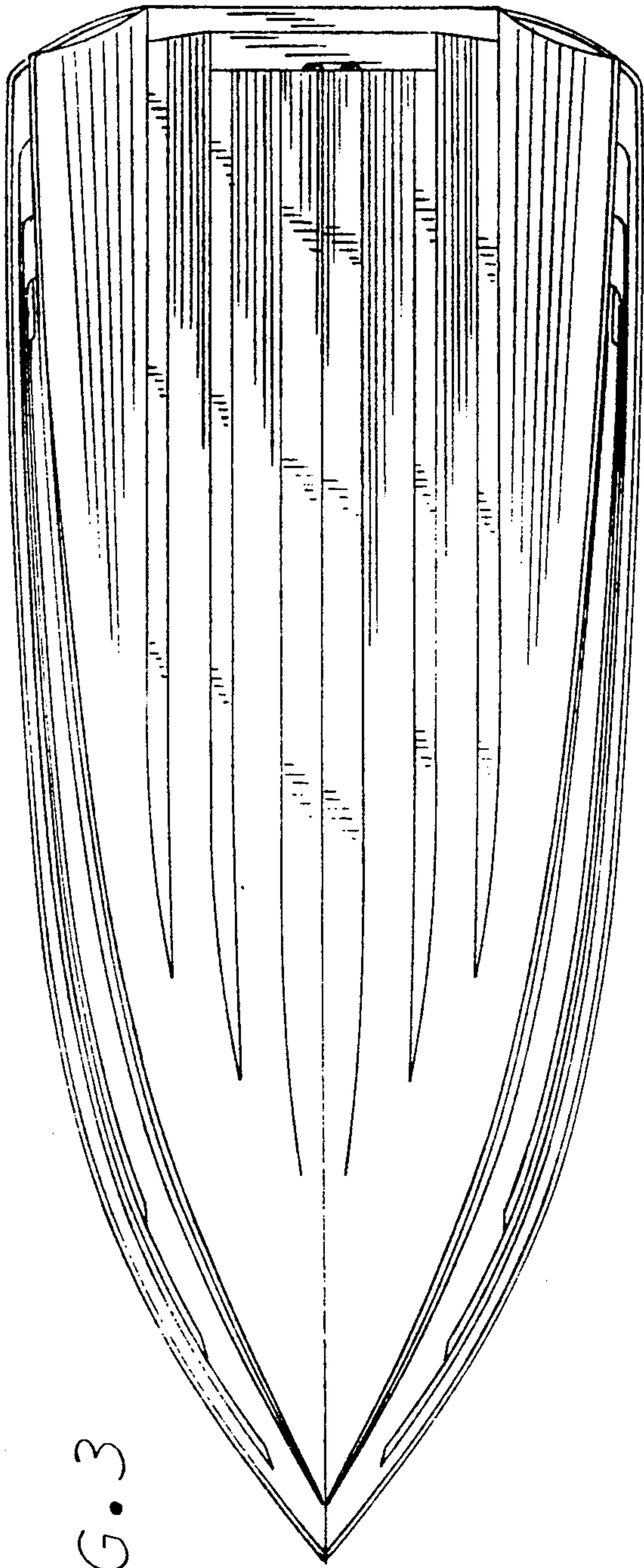

FIG. 3

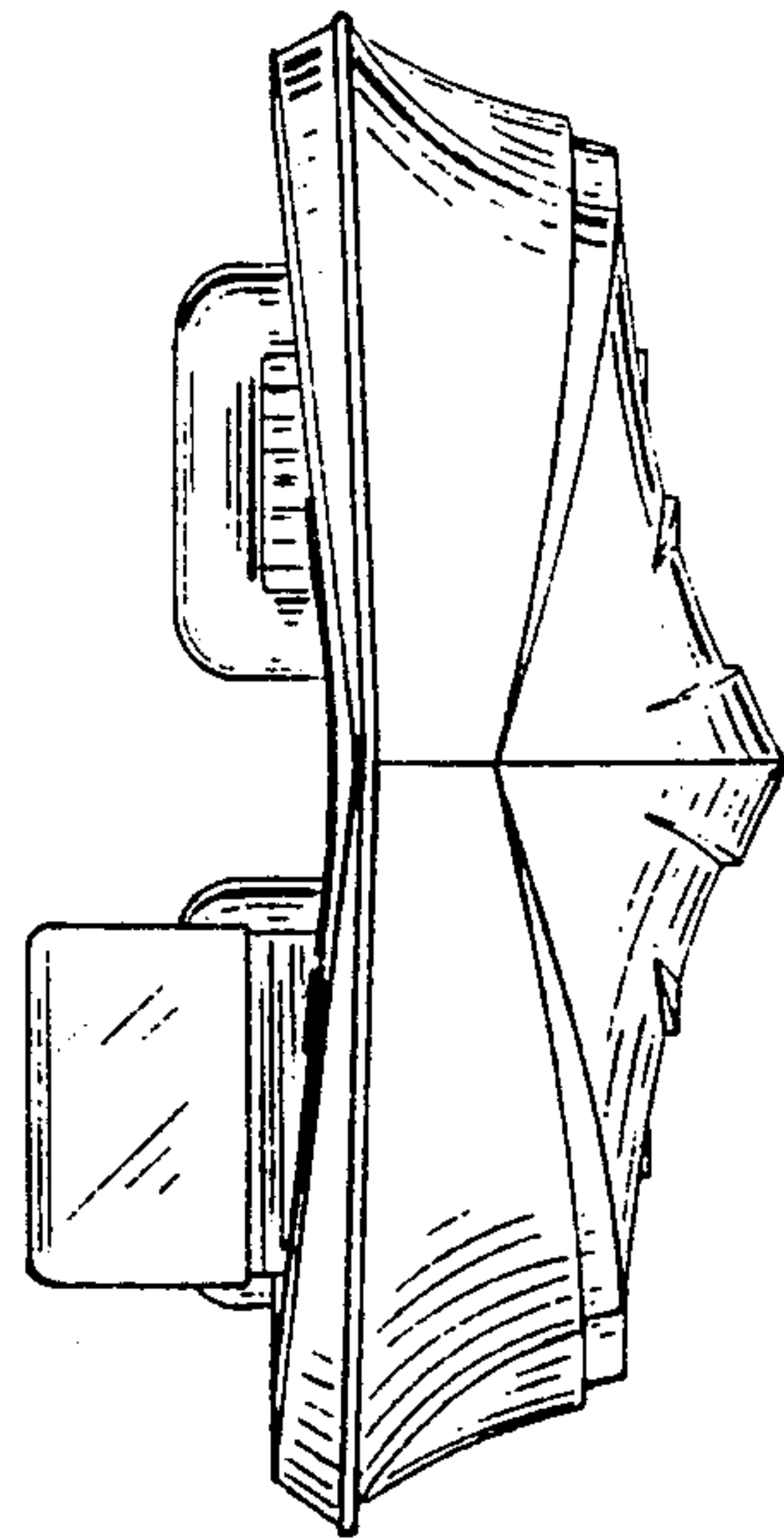

FIG. 4

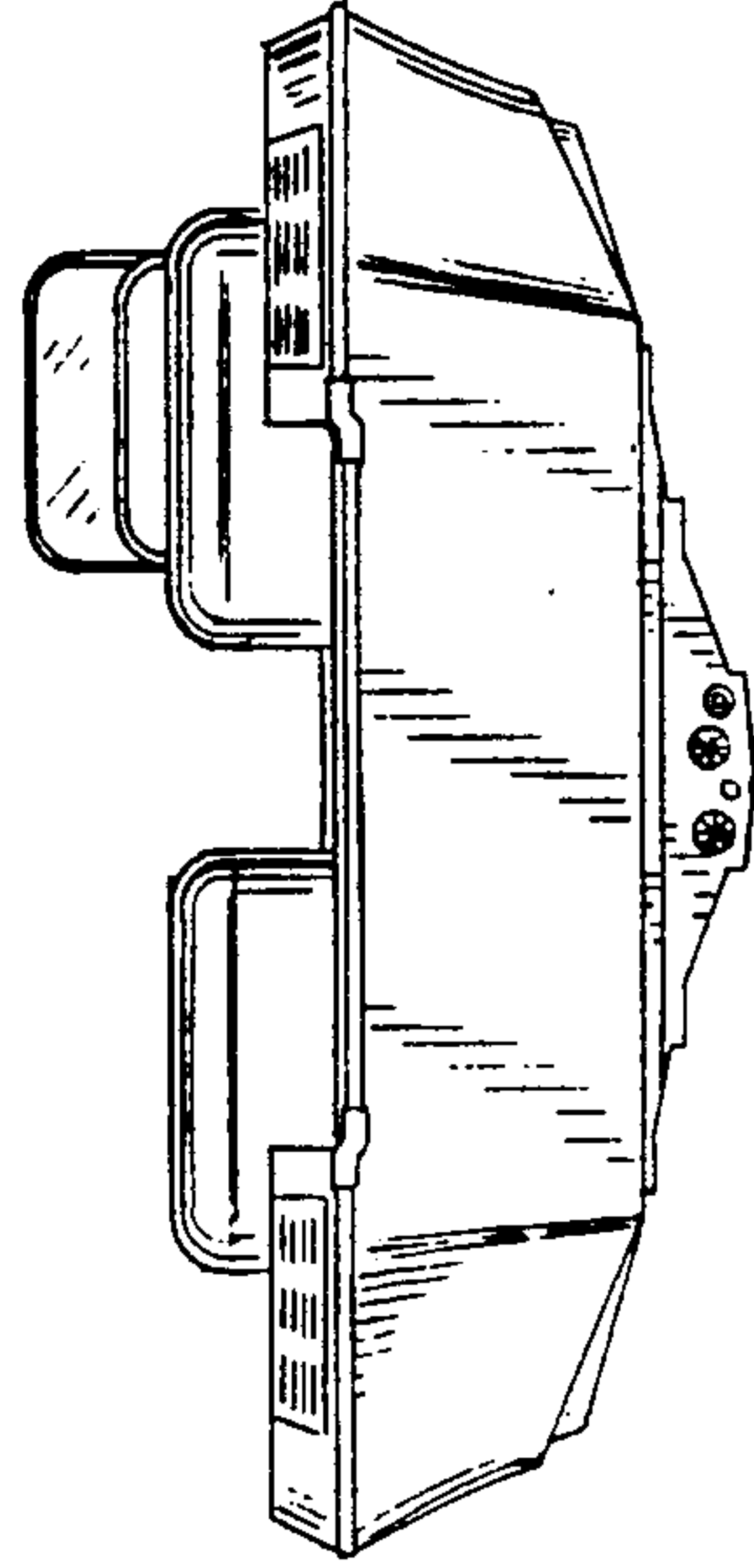

FIG. 5



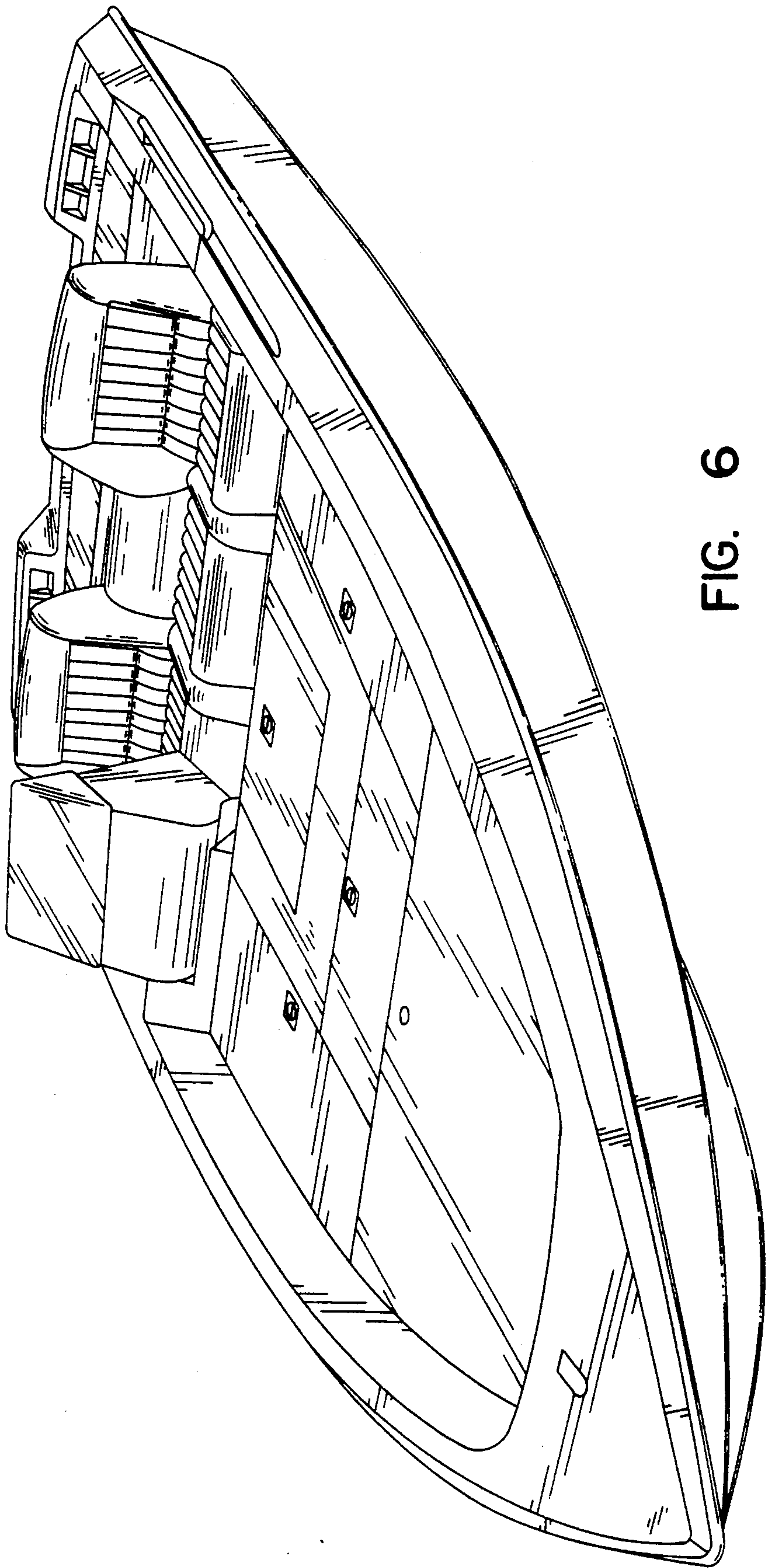

FIG. 6