



US00D326731S

United States Patent [19]

[11] Patent Number: **Des. 326,731**

Chaubard

[45] Date of Patent: **** Jun. 2, 1992**

[54] **WALL MOUNTED LIGHTING FIXTURE OR THE LIKE**

OTHER PUBLICATIONS

[76] Inventor: **Pierre Chaubard**, P.O. Box 205, Fort Montgomery, N.Y. 10922

L'Image "Dakota" Lighting Catalog ©1985, p. DK6, Wall Mounted Light Fixture.

Multiworld Lighting Suspension & Wall Lamps Catalog, 1989, Wall Lamp #DW114.

[**] Term: **14 Years**

Primary Examiner—Susan J. Lucas

Attorney, Agent, or Firm—Anthony F. Cuoco

[21] Appl. No.: **537,267**

[57] CLAIM

The ornamental design for a wall mounted lighting fixture or the like, as shown and described.

[22] Filed: **Jun. 13, 1990**

DESCRIPTION

[52] U.S. Cl. **D26/85**

FIG. 1 is a top, front perspective view of a wall mounted lighting fixture or the like showing my new design;

[58] Field of Search **D26/72, 74-92; 362/147, 151, 222, 223, 432, 362, 367**

FIG. 2 is a top plan view thereof;

FIG. 3 is a front elevational view thereof;

FIG. 4 is a left side elevational view thereof;

FIG. 5 is a right side elevational view thereof;

FIG. 6 is a bottom plan view thereof; and,

FIG. 7 is a rear elevational view thereof.

[56] References Cited

U.S. PATENT DOCUMENTS

D. 291,928 9/1987 Morten **D26/76**

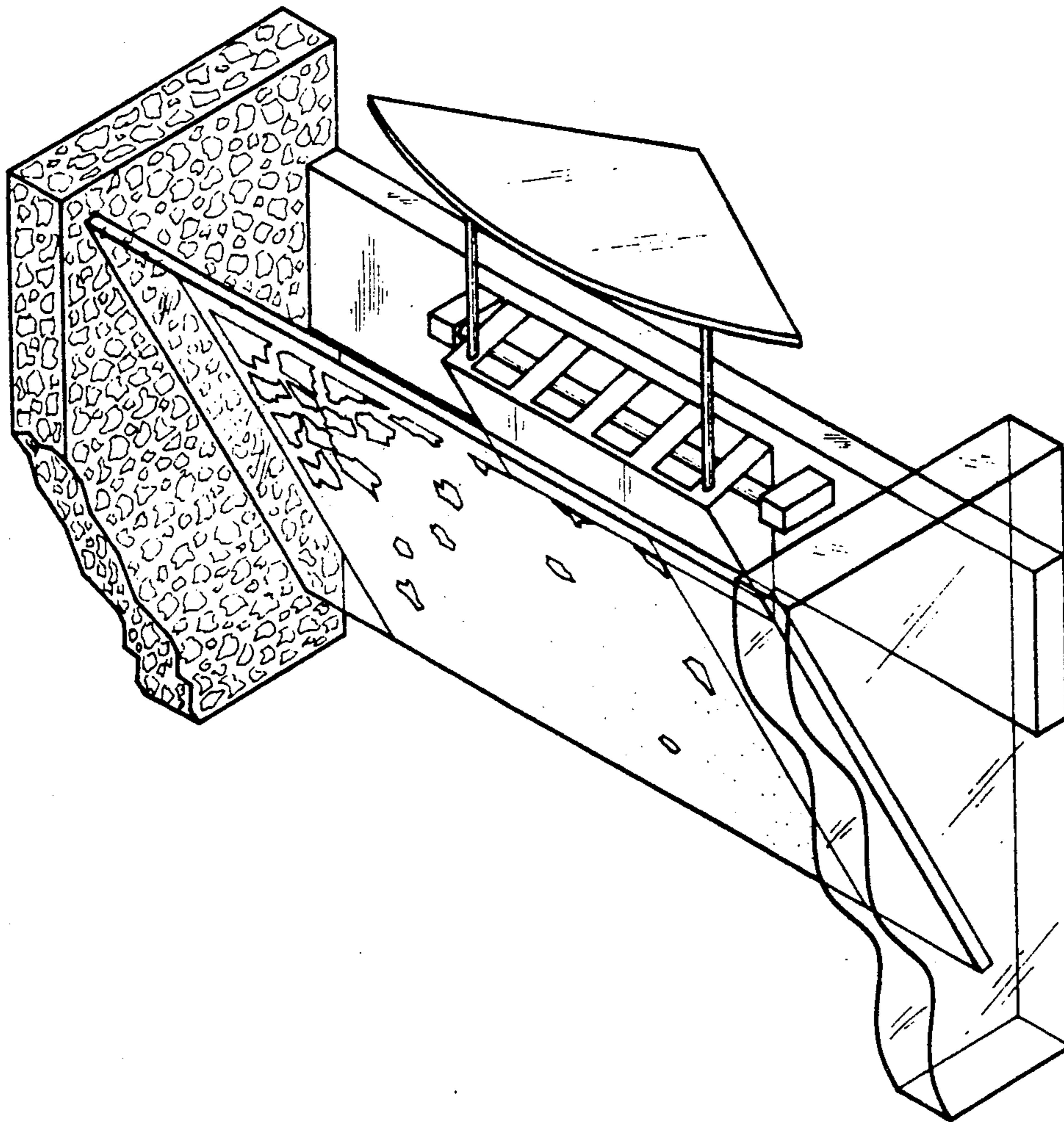

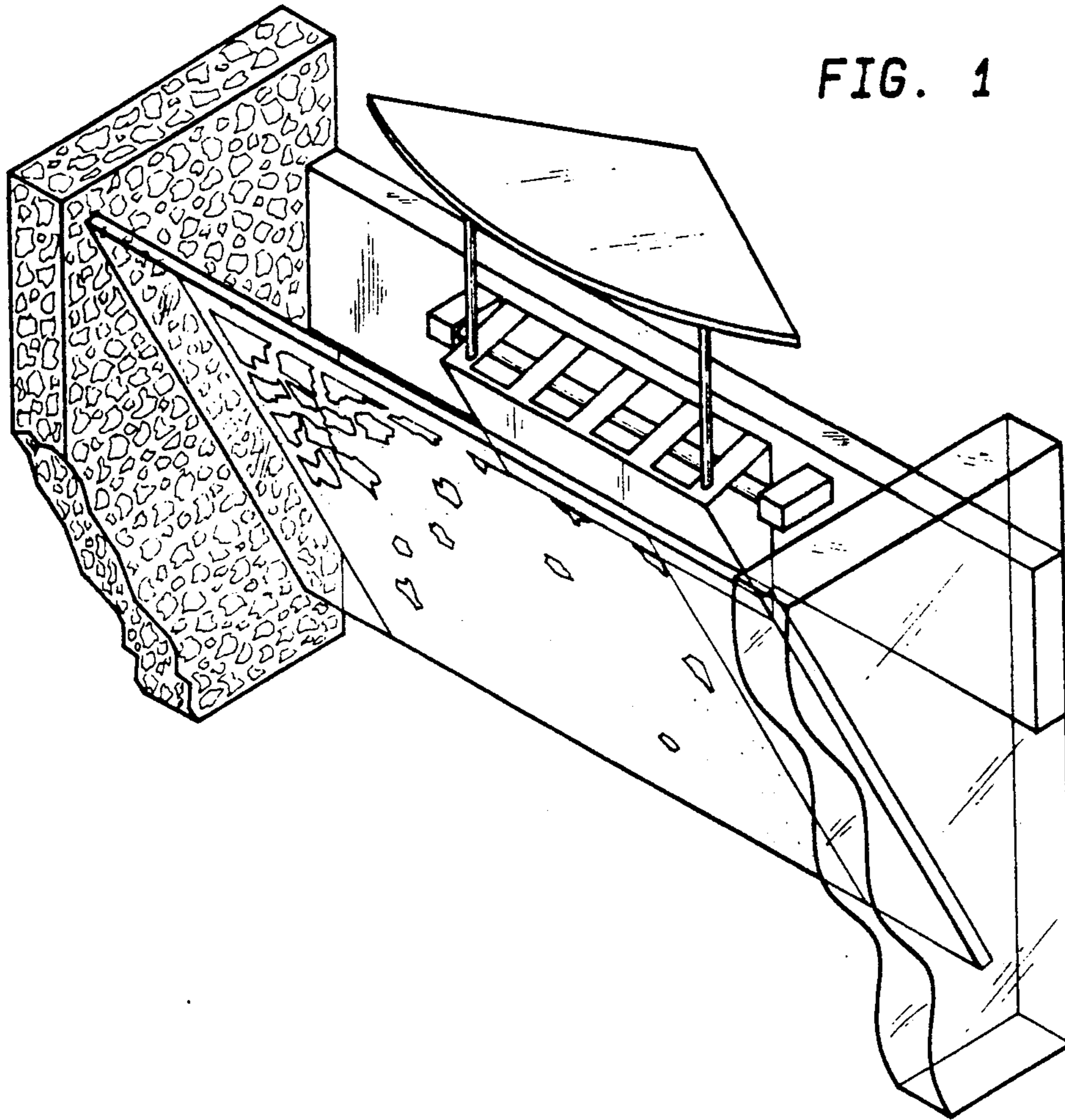

FIG. 2

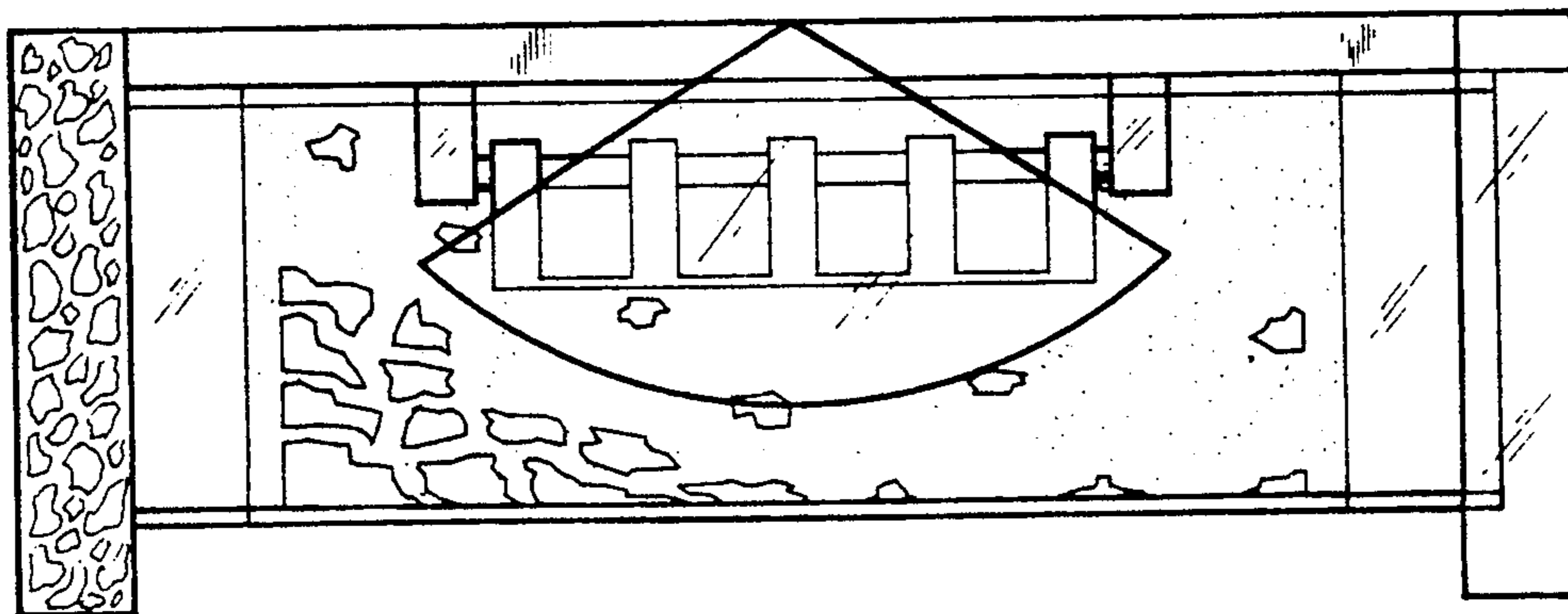

FIG. 3

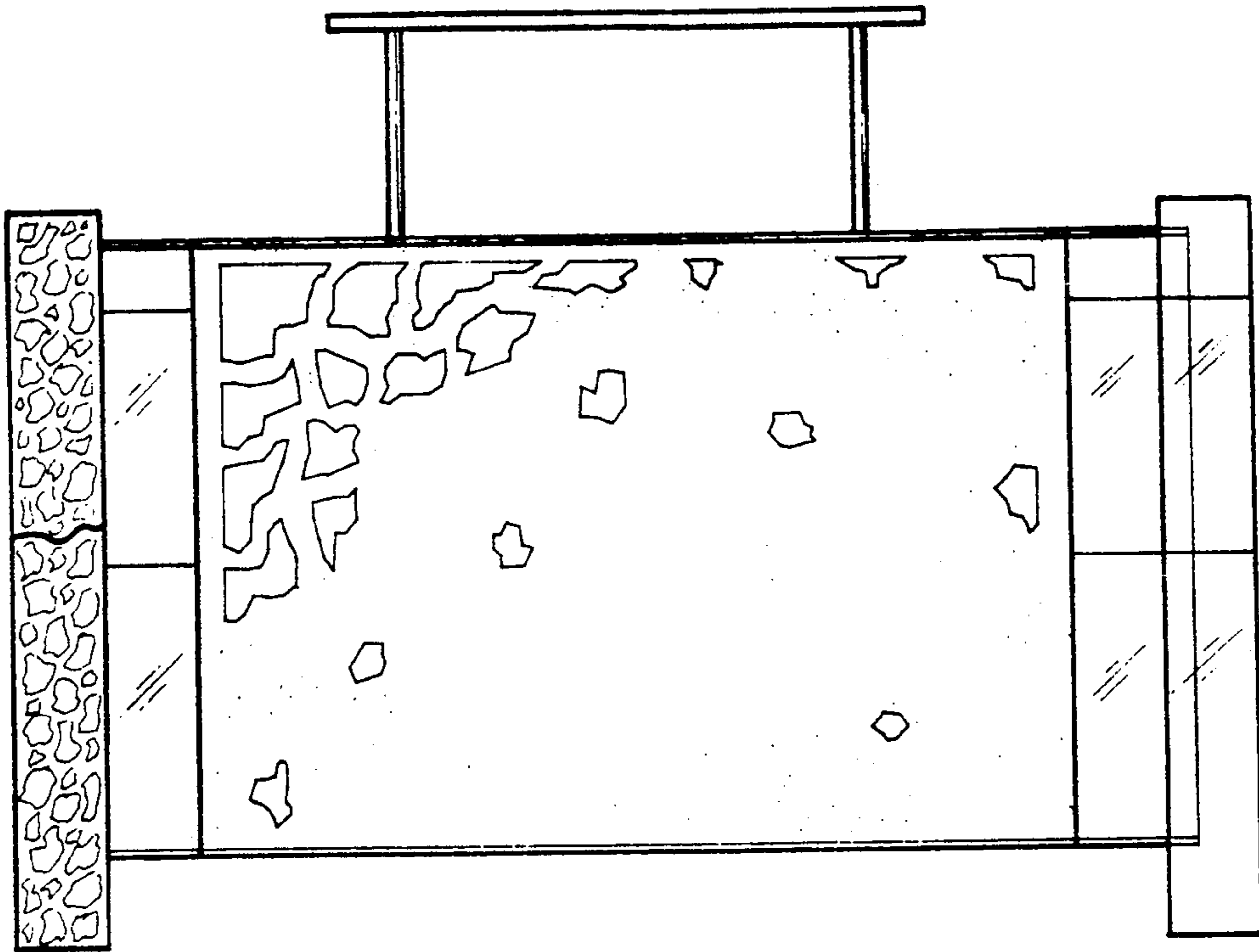

FIG. 4

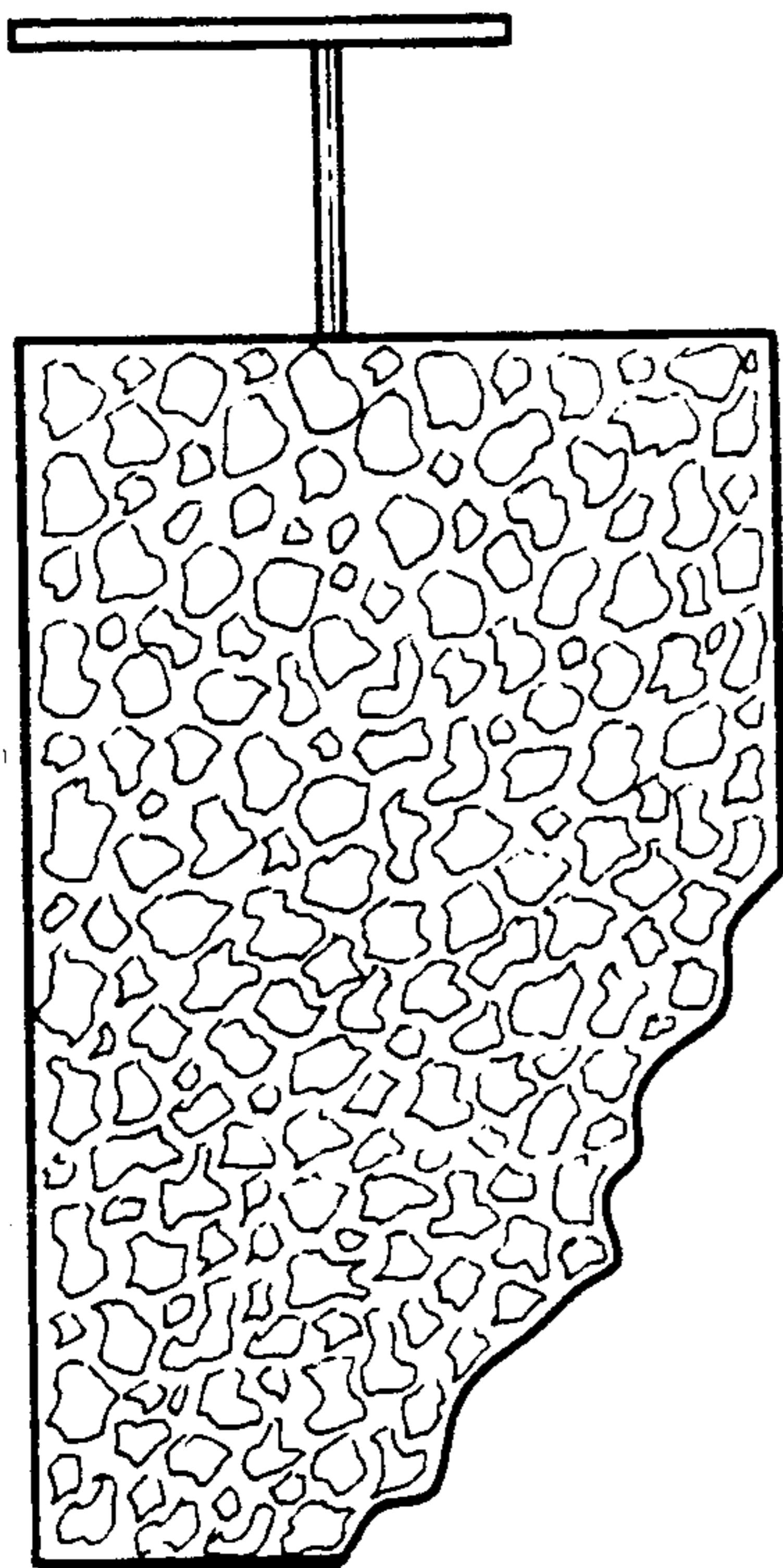

FIG. 5

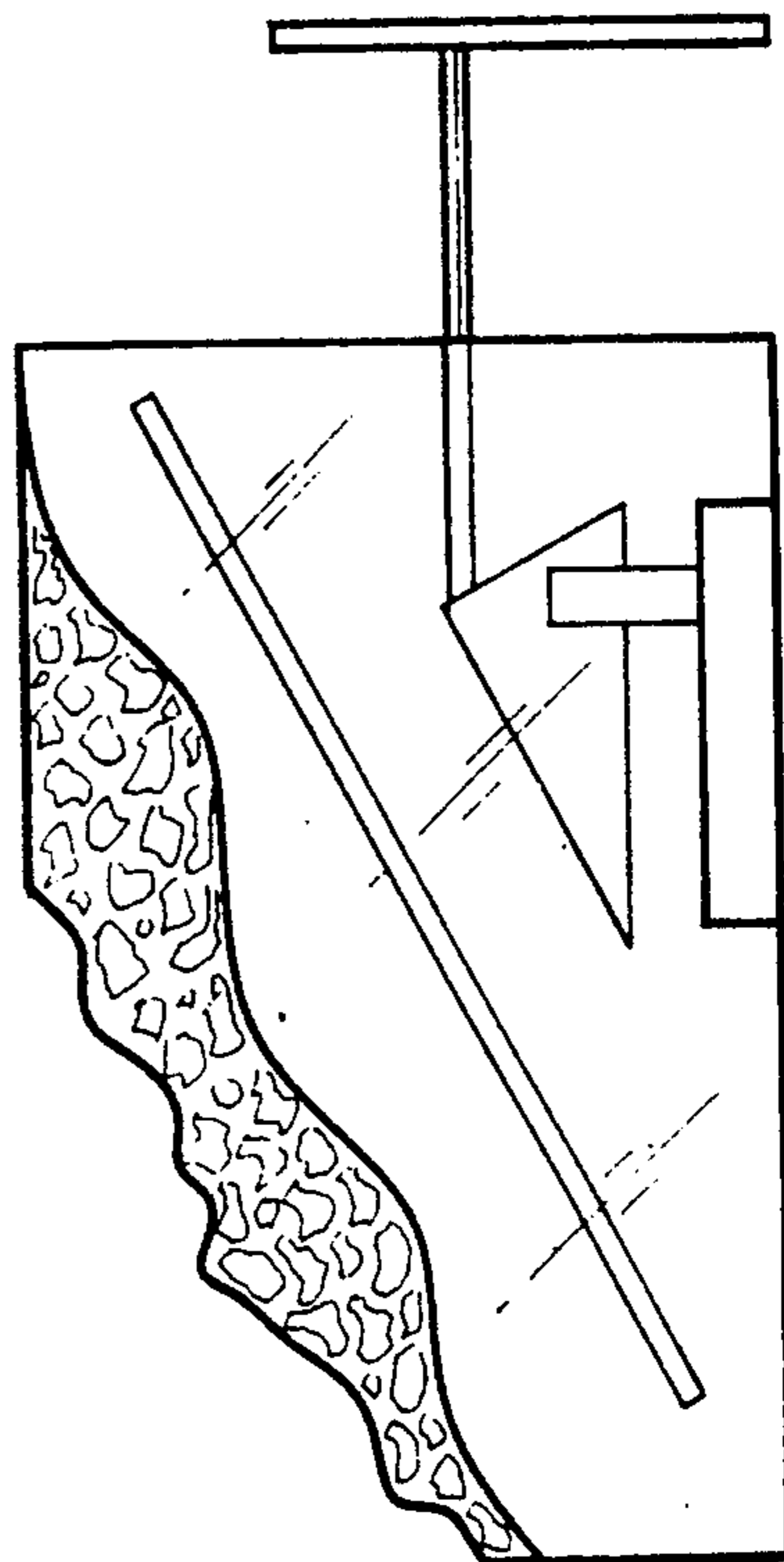

FIG. 6

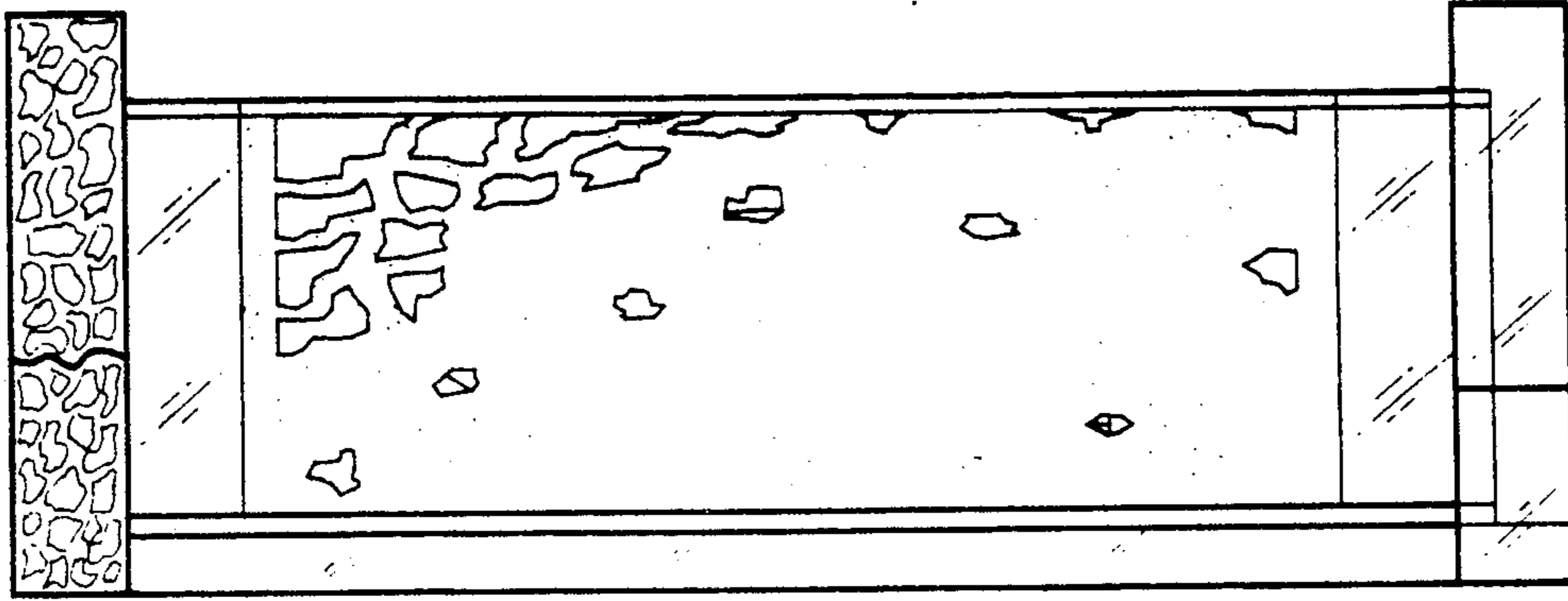

FIG. 7

