



US00D326676S

# United States Patent [19]

Wolff

[11] Patent Number: Des. 326,676

[45] Date of Patent: \*\* Jun. 2, 1992

[54] MUSIC BOX

[76] Inventor: Gustave F. Wolff, 3213 Hobcaw La., Lexington, Ky. 40502

[\*\*] Term: 14 Years

[21] Appl. No.: 370,694

[22] Filed: Jun. 23, 1989

[52] U.S. Cl. .... D17/24; D9/503

[58] Field of Search ..... D17/24; D9/349, 352, D9/353; D6/495; 84/94.1, 95.1

[56] **References Cited**

**U.S. PATENT DOCUMENTS**

D. 47,937	10/1915	Taussig	.....	D6/495
D. 74,417	2/1928	Clarke	.....	D9/353
D. 164,003	7/1951	Kelley	.....	D17/24
D. 171,437	2/1954	Breen	.....	D17/24
D. 222,595	11/1971	Blessing	.....	D17/24

D. 264,462	5/1982	Glass	.....	D17/24
D. 265,836	8/1982	Ahn	.....	D17/24

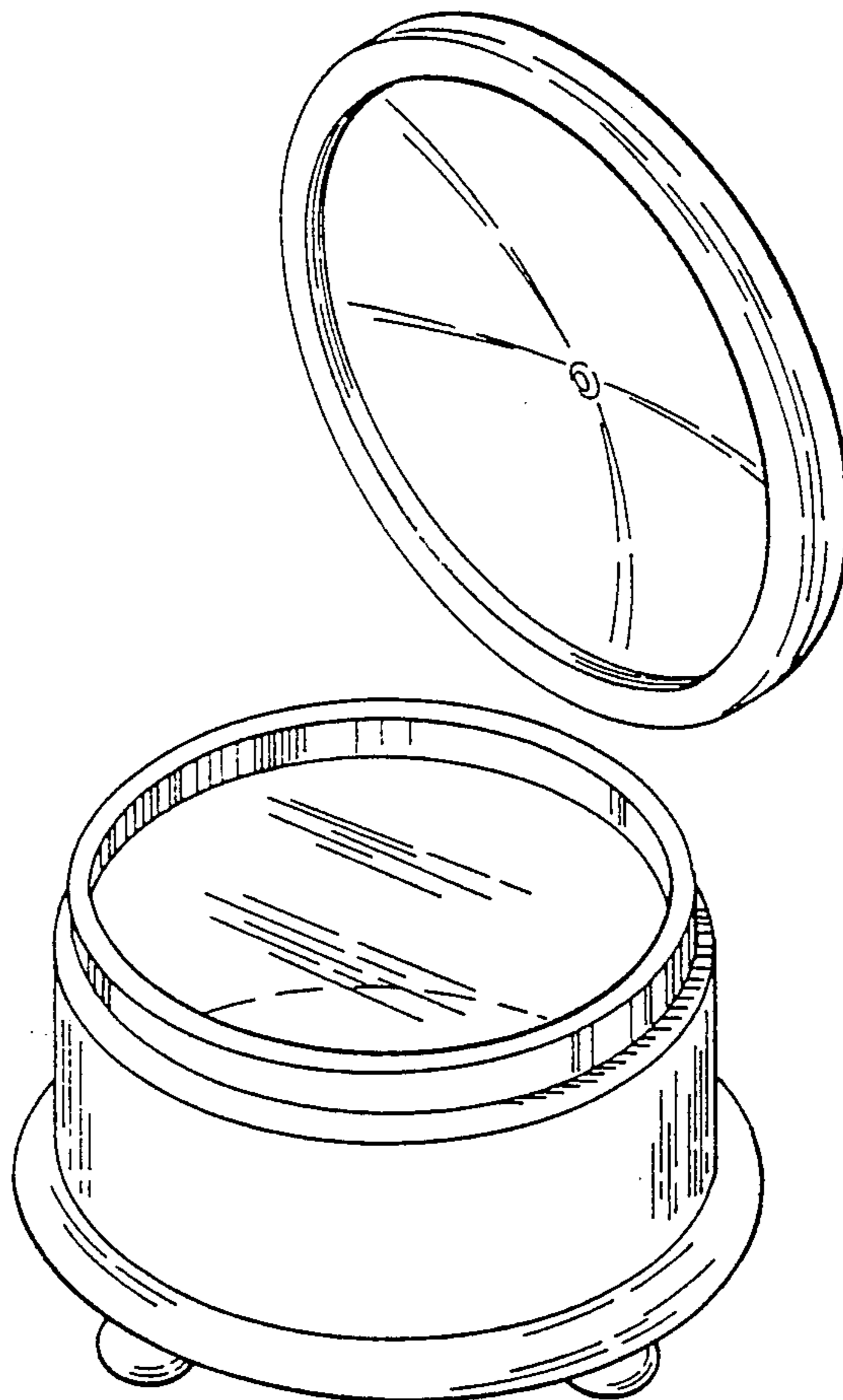
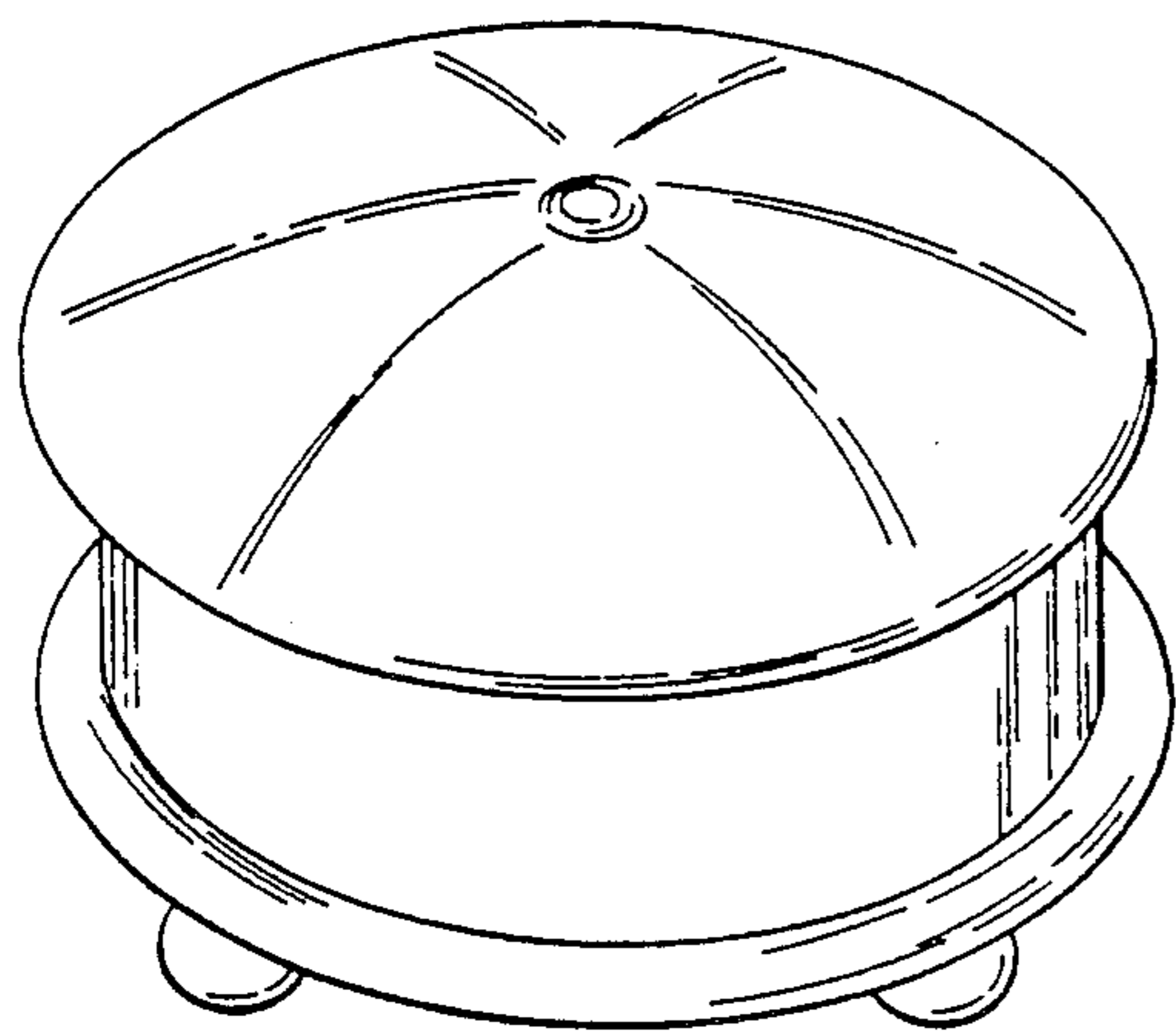
Primary Examiner—Bernard Ansher  
Assistant Examiner—Dominic Simone  
Attorney, Agent, or Firm—King & Schickli

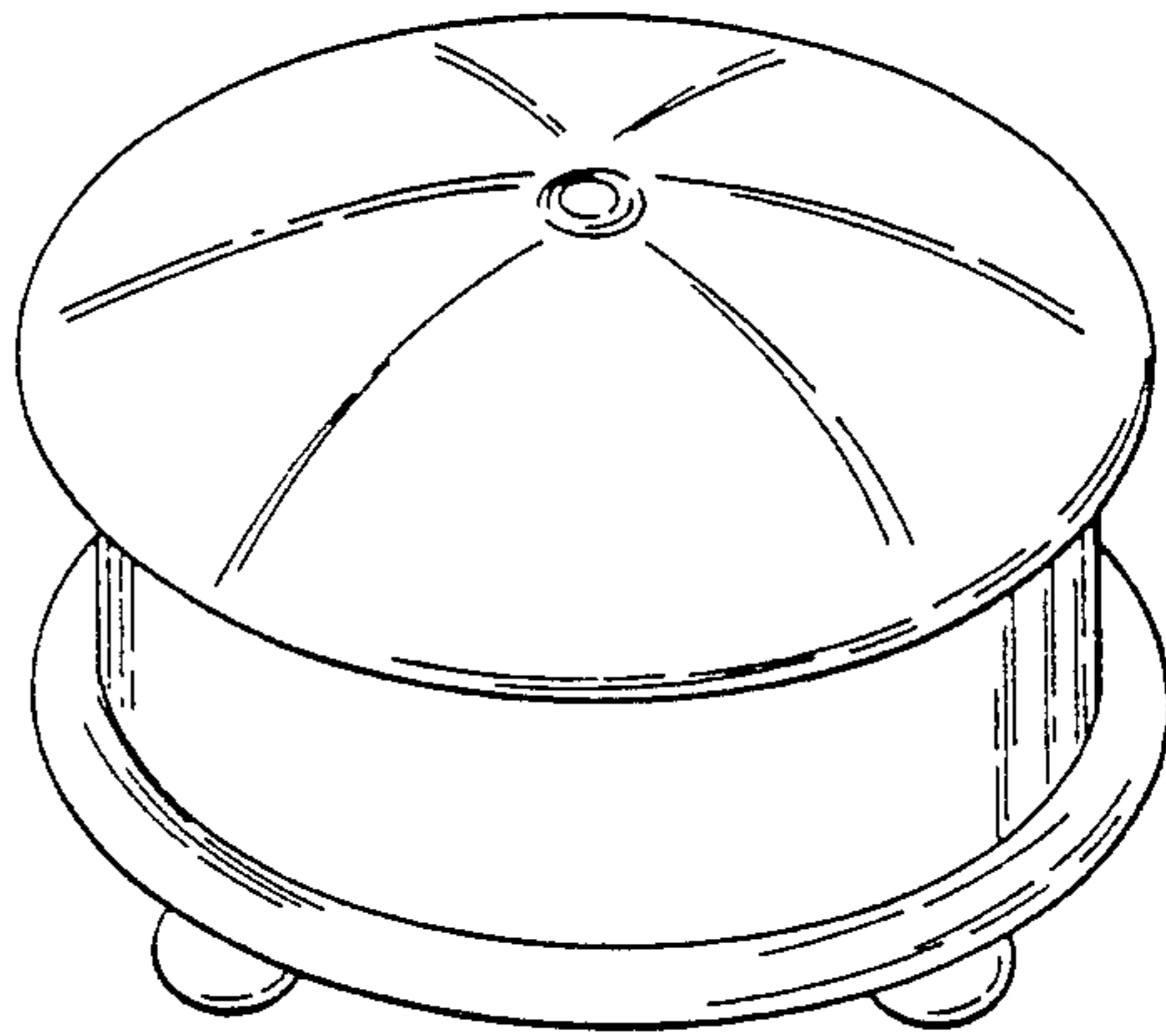
[57] **CLAIM**

The ornamental design for music box, as shown.

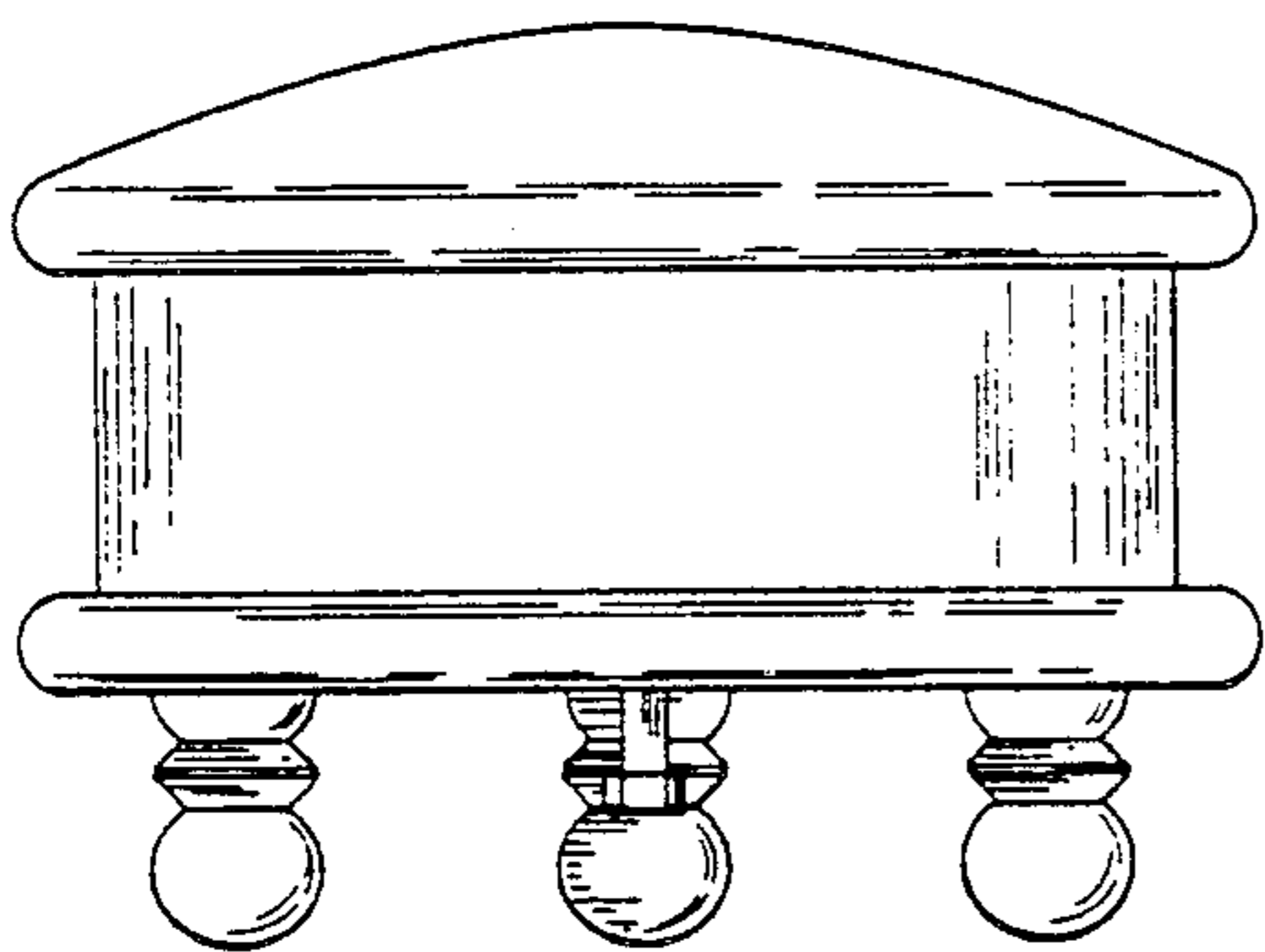
**DESCRIPTION**

FIG. 1 is a front perspective view of a music box showing my new design;  
FIG. 2 is a front elevational view;  
FIG. 3 is a right side elevational view thereof, the left side being a mirror image;  
FIG. 4 is a rear elevational view;  
FIG. 5 is a top plan view;  
FIG. 6 is a bottom plan view; and,  
FIG. 7 is an exploded front perspective view thereof.

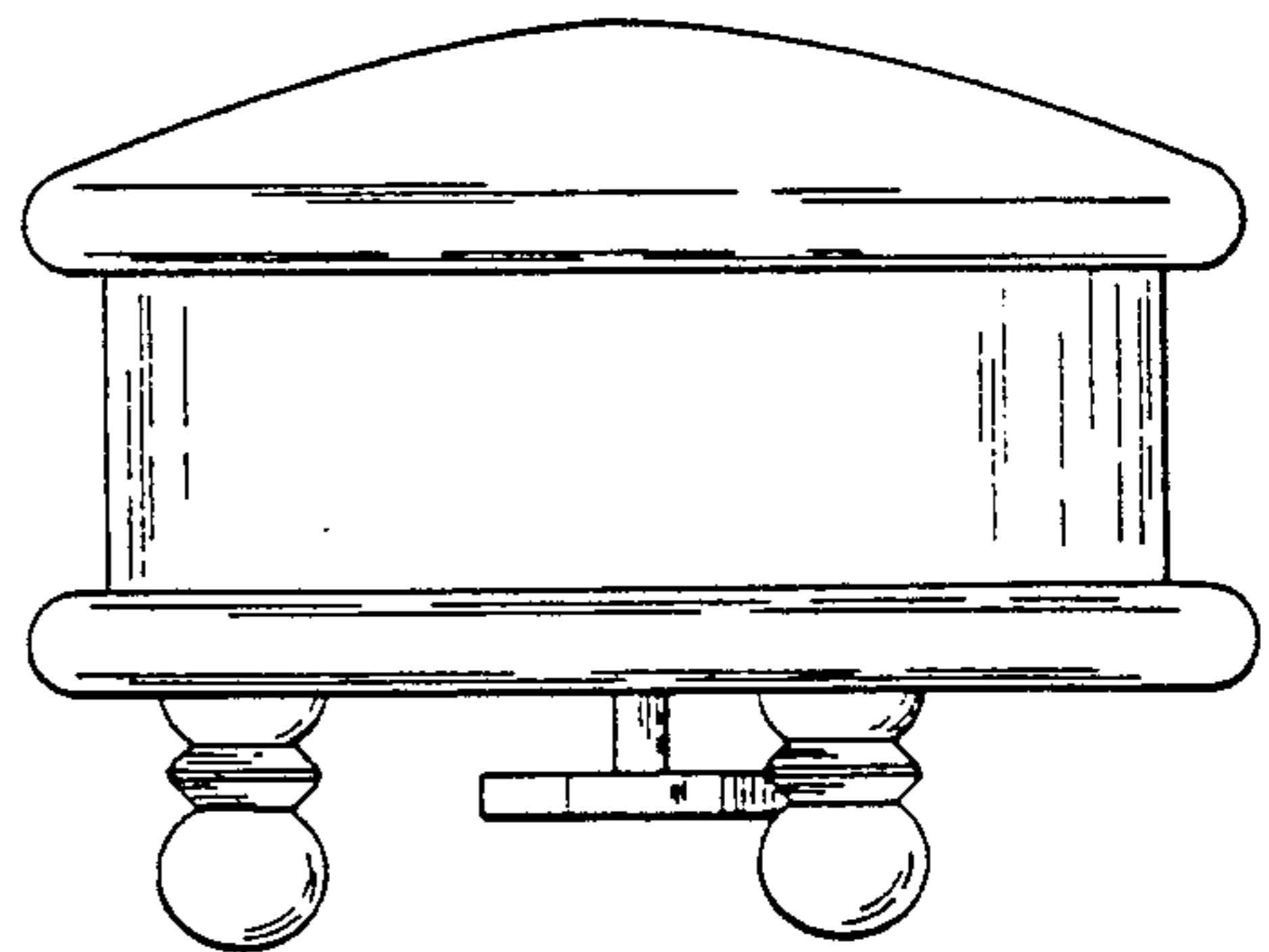




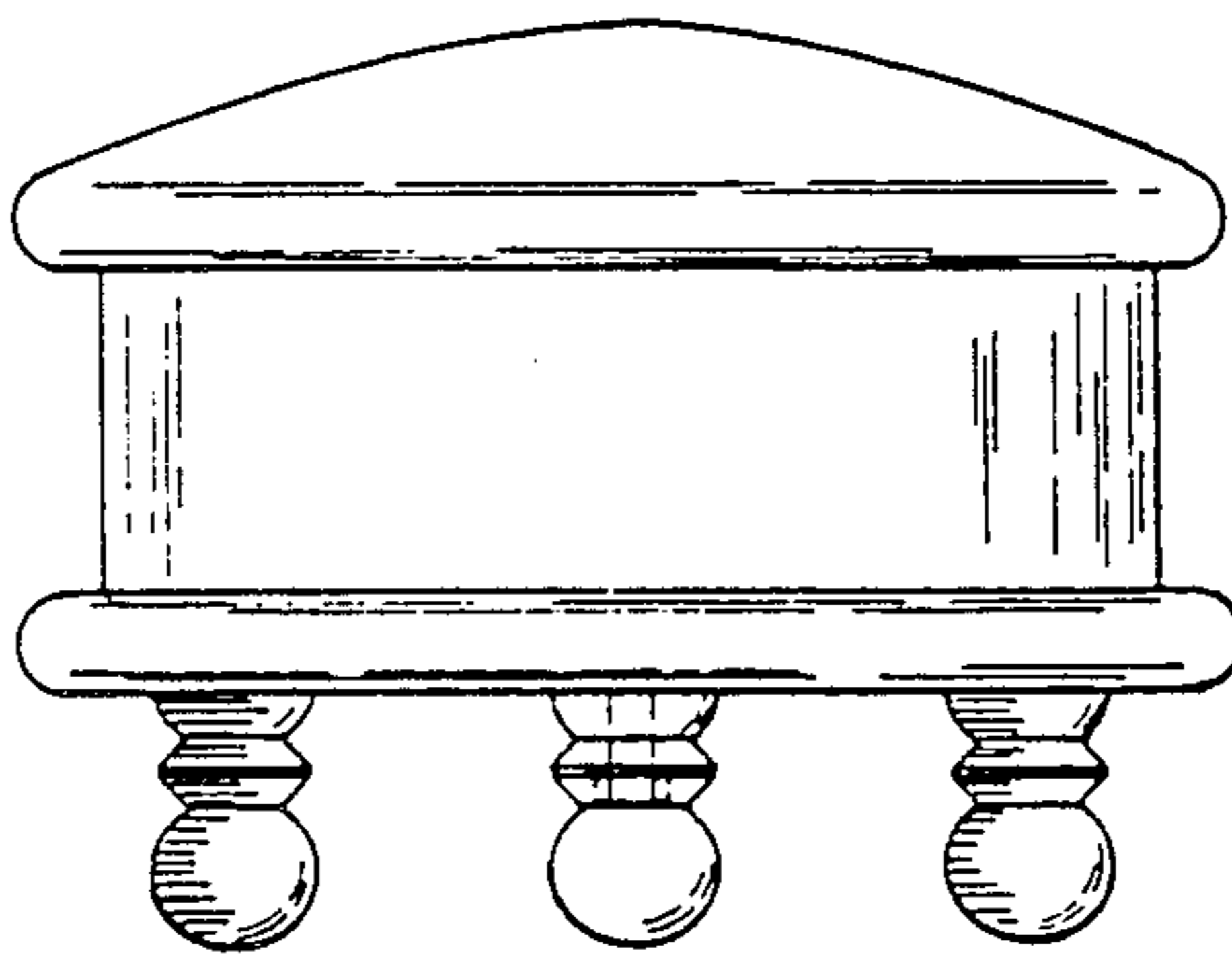
*Fig. 1*



*Fig. 2*

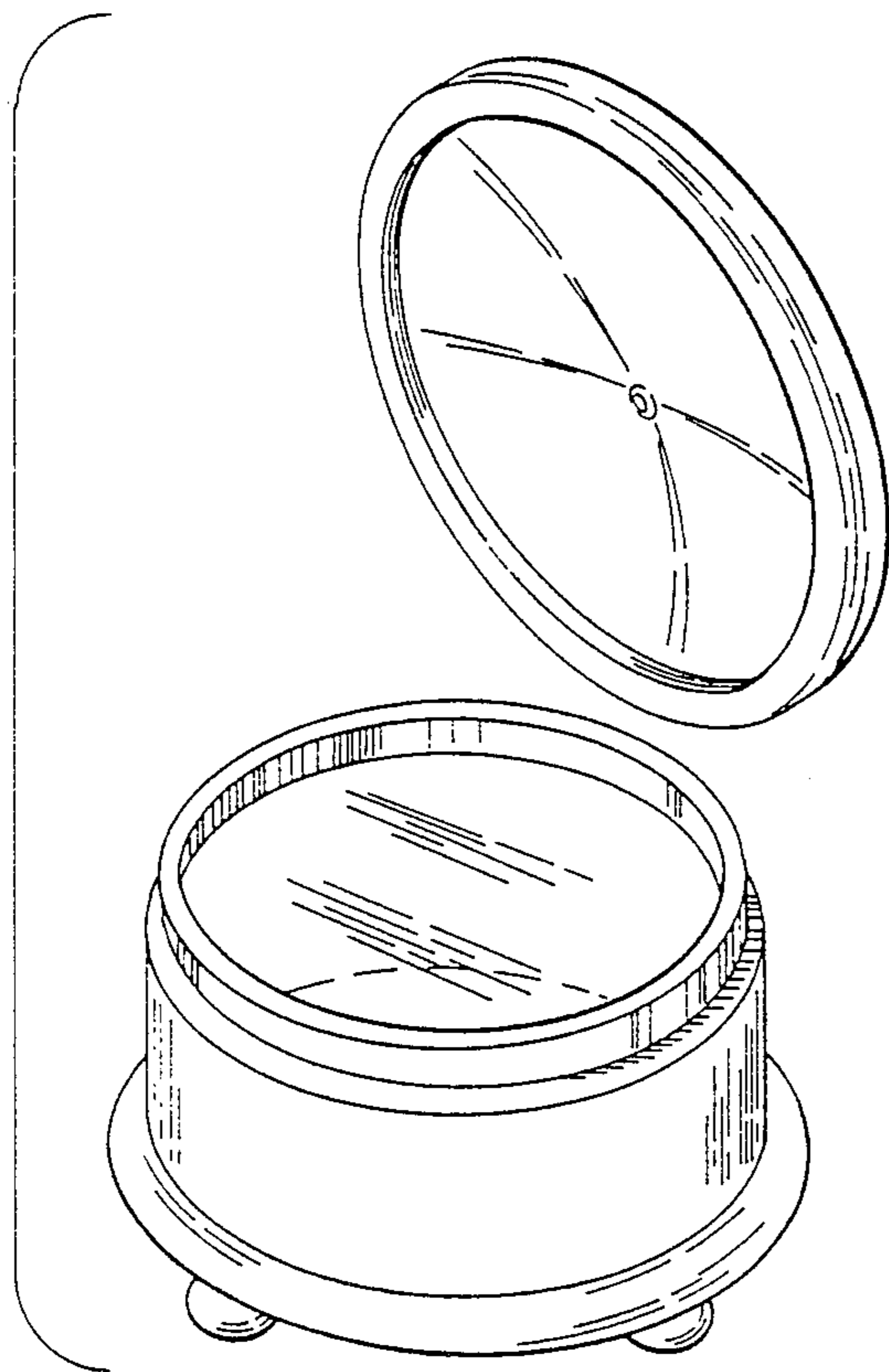


*Fig. 3*

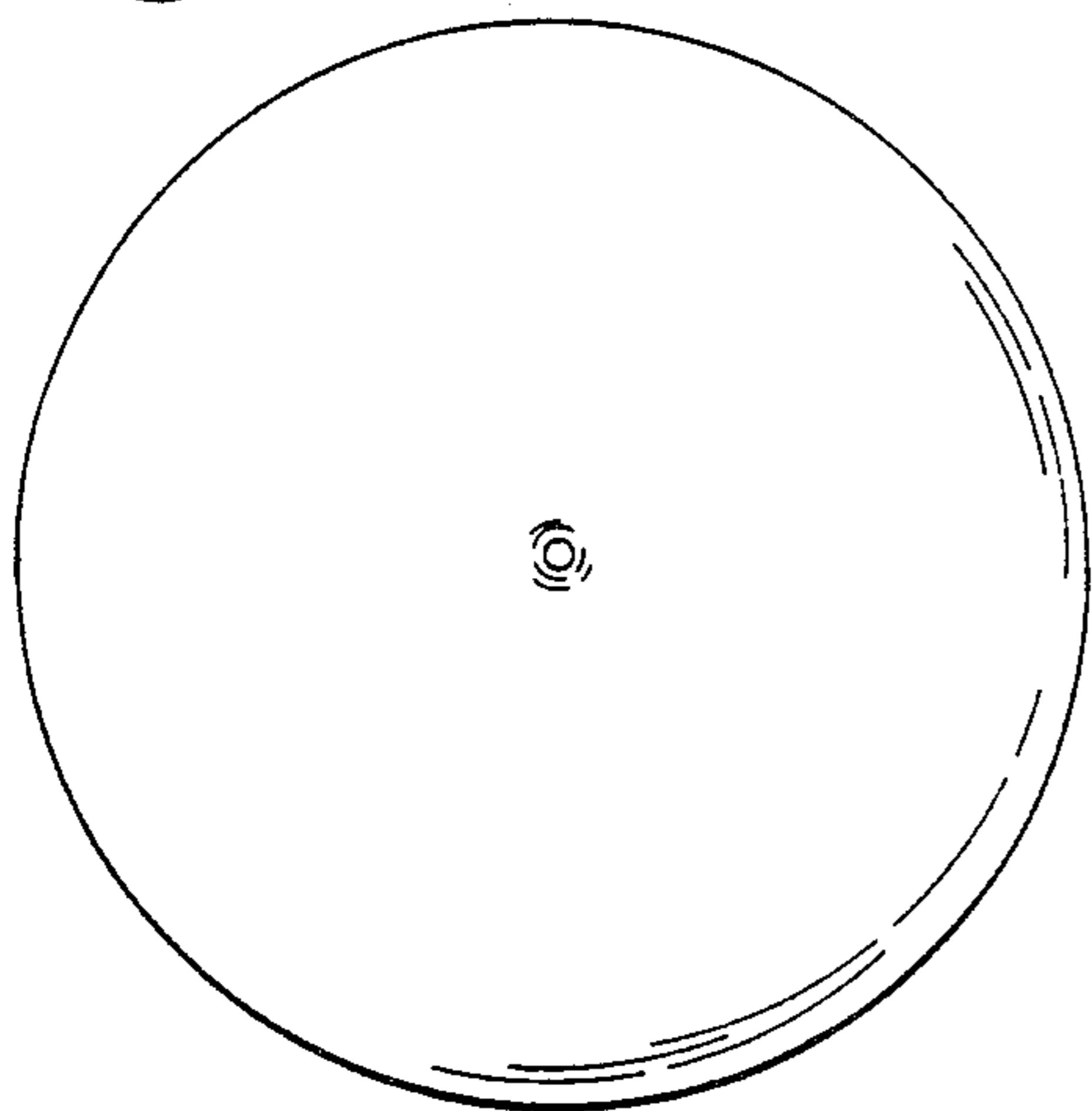


*Fig. 4*

*Fig. 7*



*Fig. 5*



*Fig. 6*

