



US00D326619S

# United States Patent [19]

[11] Patent Number: Des. 326,619

Soloway

[45] Date of Patent: \*\* Jun. 2, 1992

[54] KEYPAD FOR A SECURITY SYSTEM

Attorney, Agent, or Firm—Dilworth & Barrese

[75] Inventor: Richard Soloway, Amityville, N.Y.

[57] CLAIM

[73] Assignee: NAPCO Security Systems, Inc., Amityville, N.Y.

The ornamental designs for a keypad for a security system, as shown and described.

[\*\*] Term: 14 Years

### DESCRIPTION

[21] Appl. No.: 506,354

FIG. 1 is a front elevational view of a keypad for a security system showing my new design;

[22] Filed: Apr. 6, 1990

FIG. 2 is a right side elevational view thereof, with the left side being a mirror image, except for the width of the read-out shield;

[52] U.S. Cl. .... D10/106

[58] Field of Search ..... D10/104, 106, 121; D18/1, 2, 6, 7, 11; 340/541, 542, 551, 590, 693

FIG. 3 is a perspective view thereof;

FIG. 4 is a front elevational view of a second embodiment, wherein the only difference resides in the appearance of the keys;

### [56] References Cited

#### U.S. PATENT DOCUMENTS

D. 238,733	2/1976	Goldsamt	.....	D18/7
D. 276,599	12/1984	Segan et al.	.....	D10/106
D. 278,830	5/1985	Funato et al.	.....	D18/1
D. 282,463	2/1986	Barr et al.	.....	D10/106
D. 283,406	4/1986	Green, Jr.	.....	D10/106
D. 305,211	12/1989	Horn	.....	D10/106
D. 310,791	9/1990	Farrell et al.	.....	D10/106
D. 312,221	11/1990	Steele et al.	.....	D10/106

FIG. 5 is a right side elevational view thereof, with the left side being a mirror image, except for the width of the read-out shield;

FIG. 6 is a perspective view thereof;

FIG. 7 is a front elevational view of a third embodiment wherein the only difference resides in the appearance of the keys;

Primary Examiner—Wallace R. Burke

Assistant Examiner—Marcus Jackson

FIG. 8 is a right side elevational view thereof, with the left side being a mirror image, except for the width of the read-out shield; and,

FIG. 9 is a perspective view thereof.

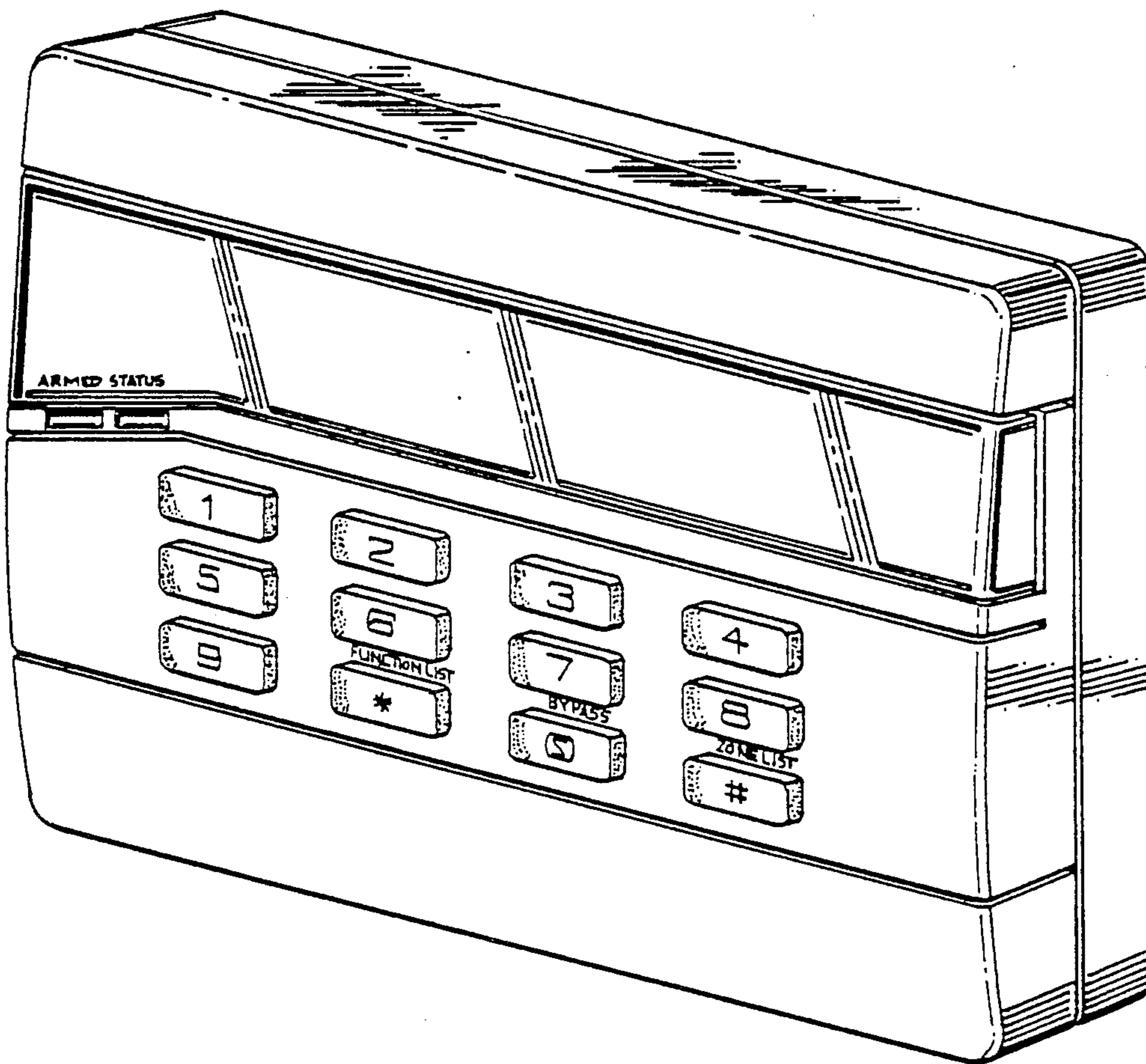

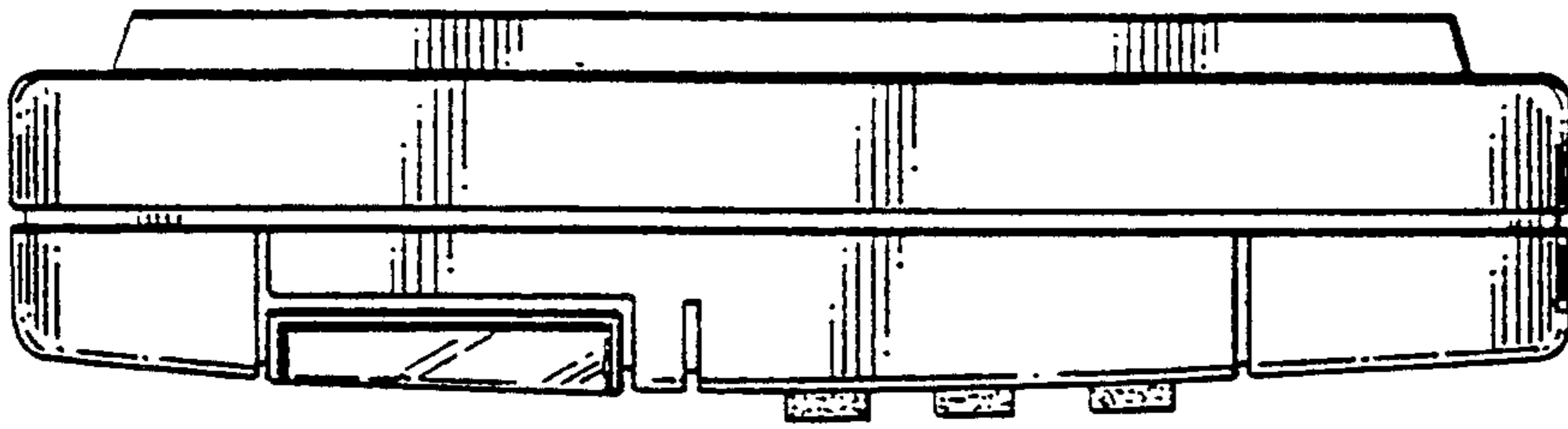

FIG. 2

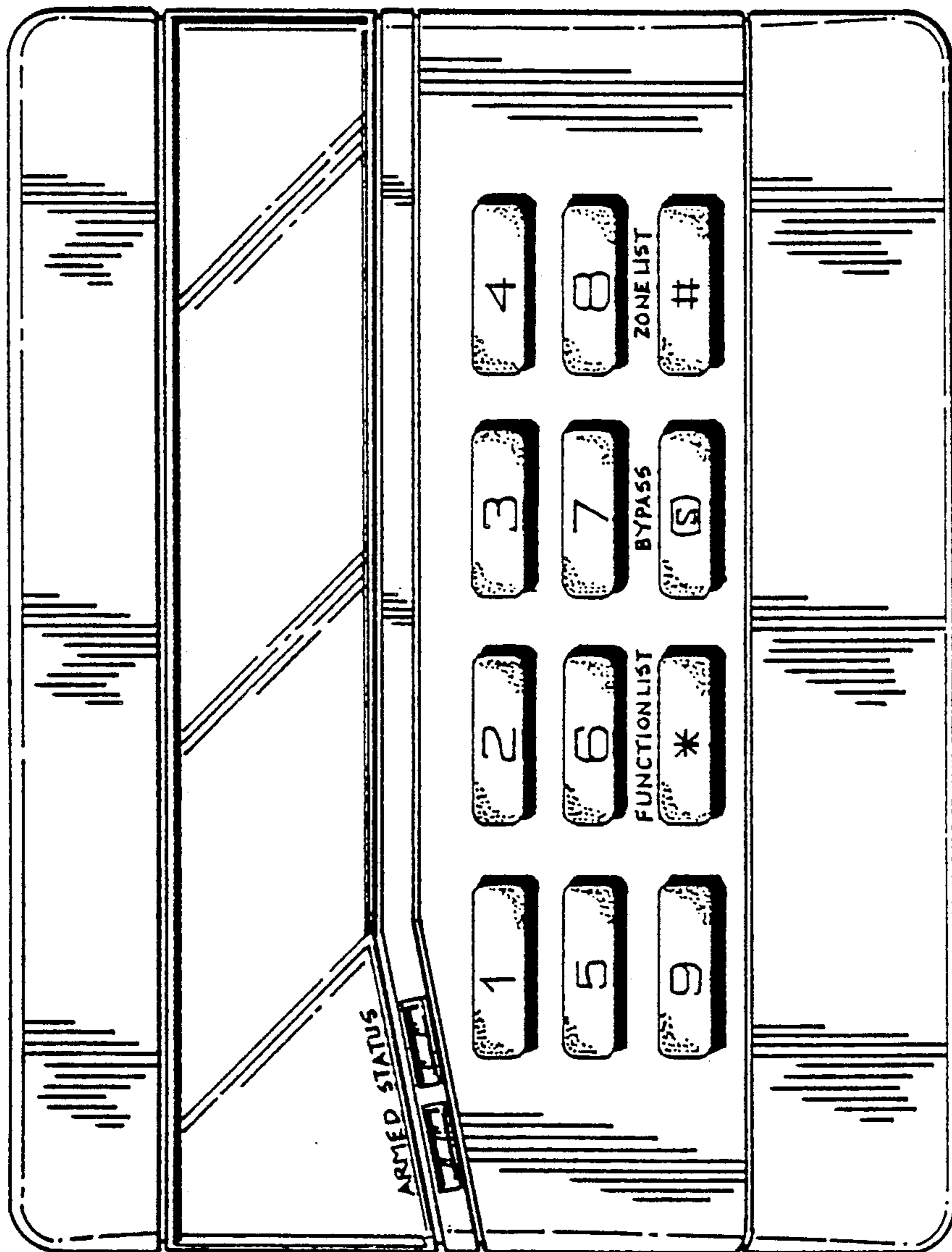

FIG. 1

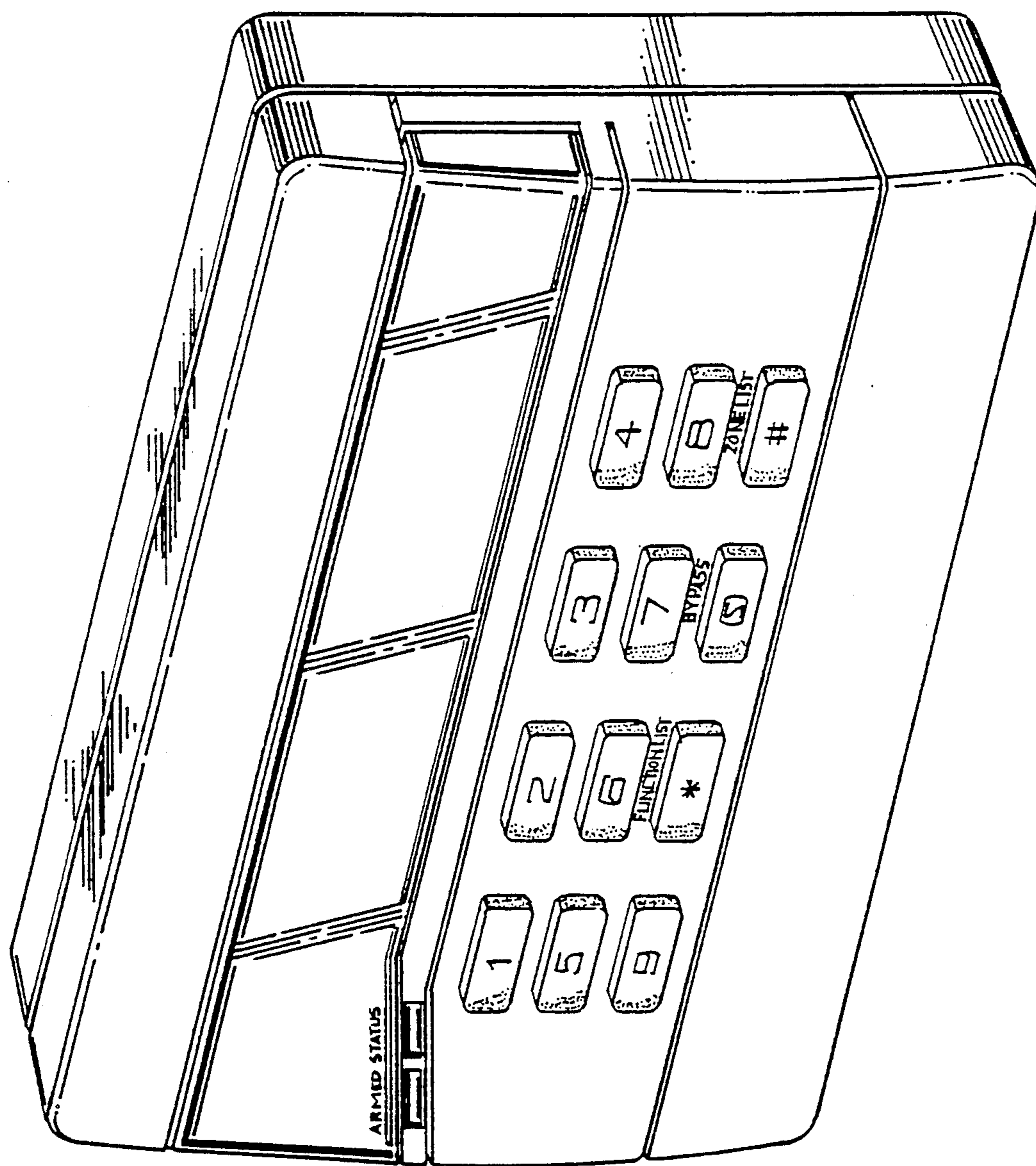

FIG. 3

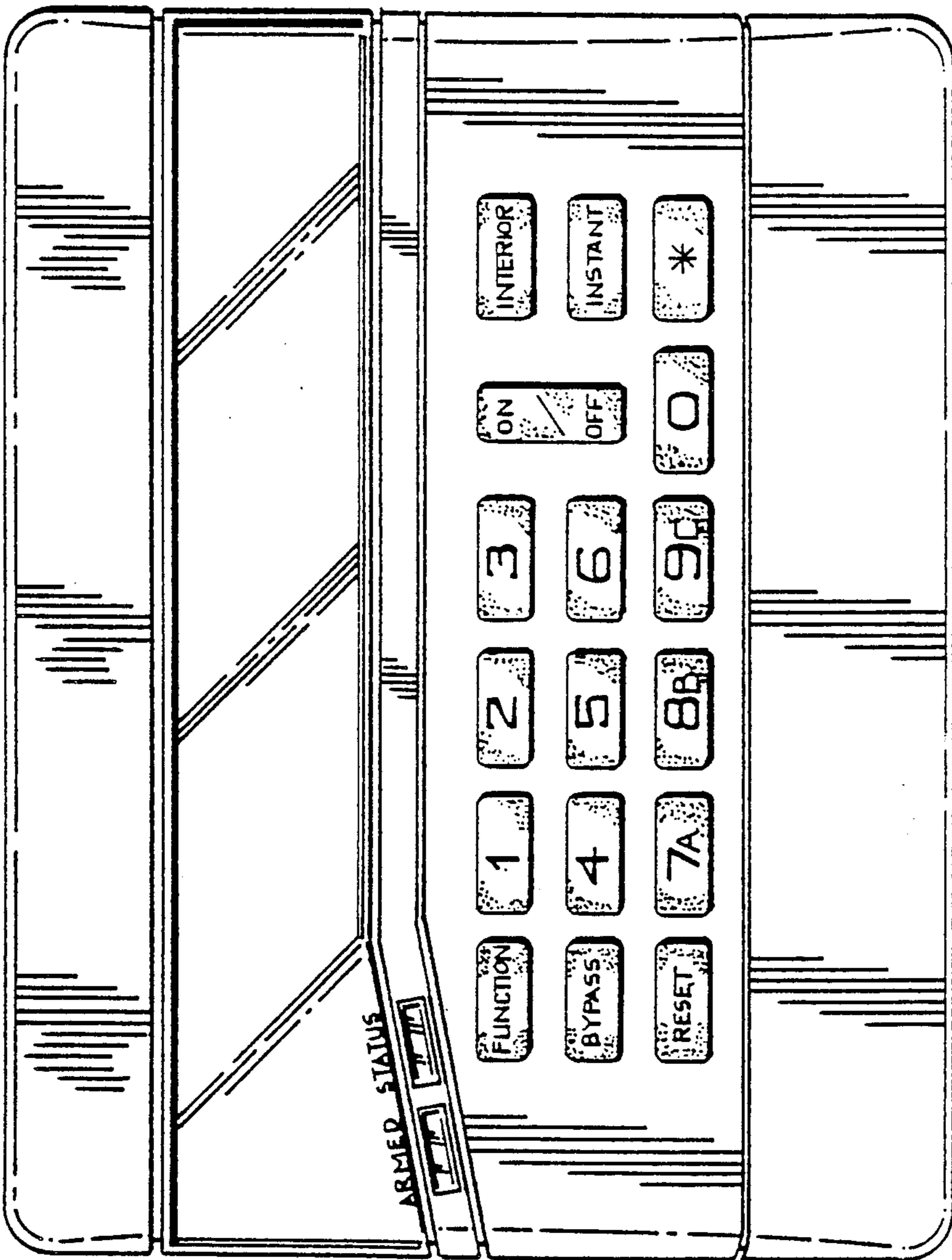

FIG. 4

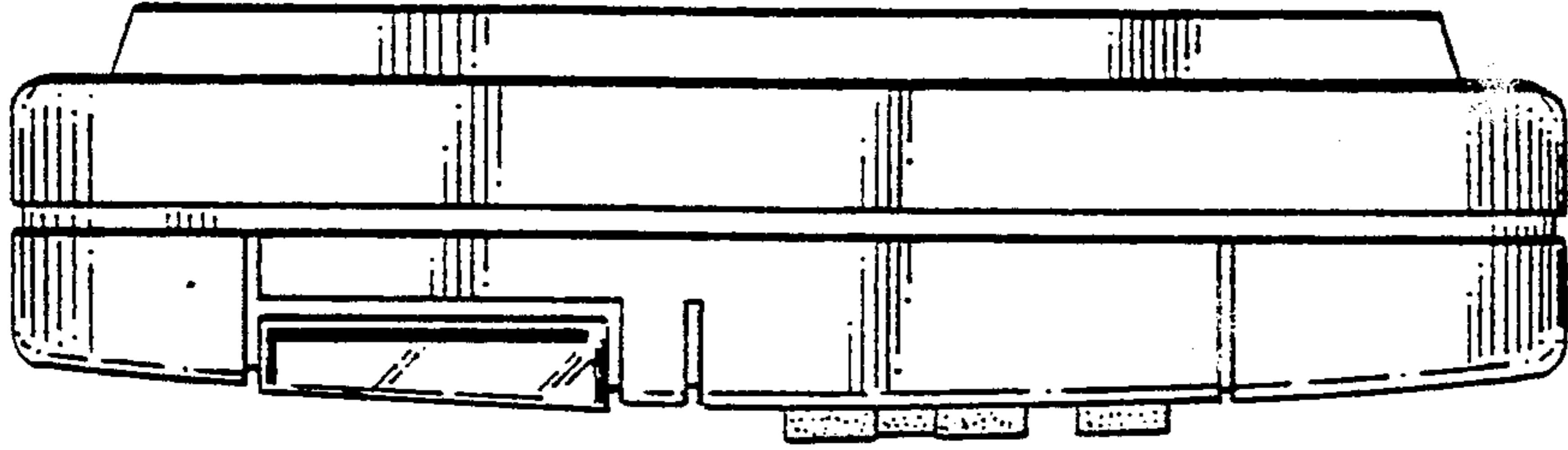

FIG. 5

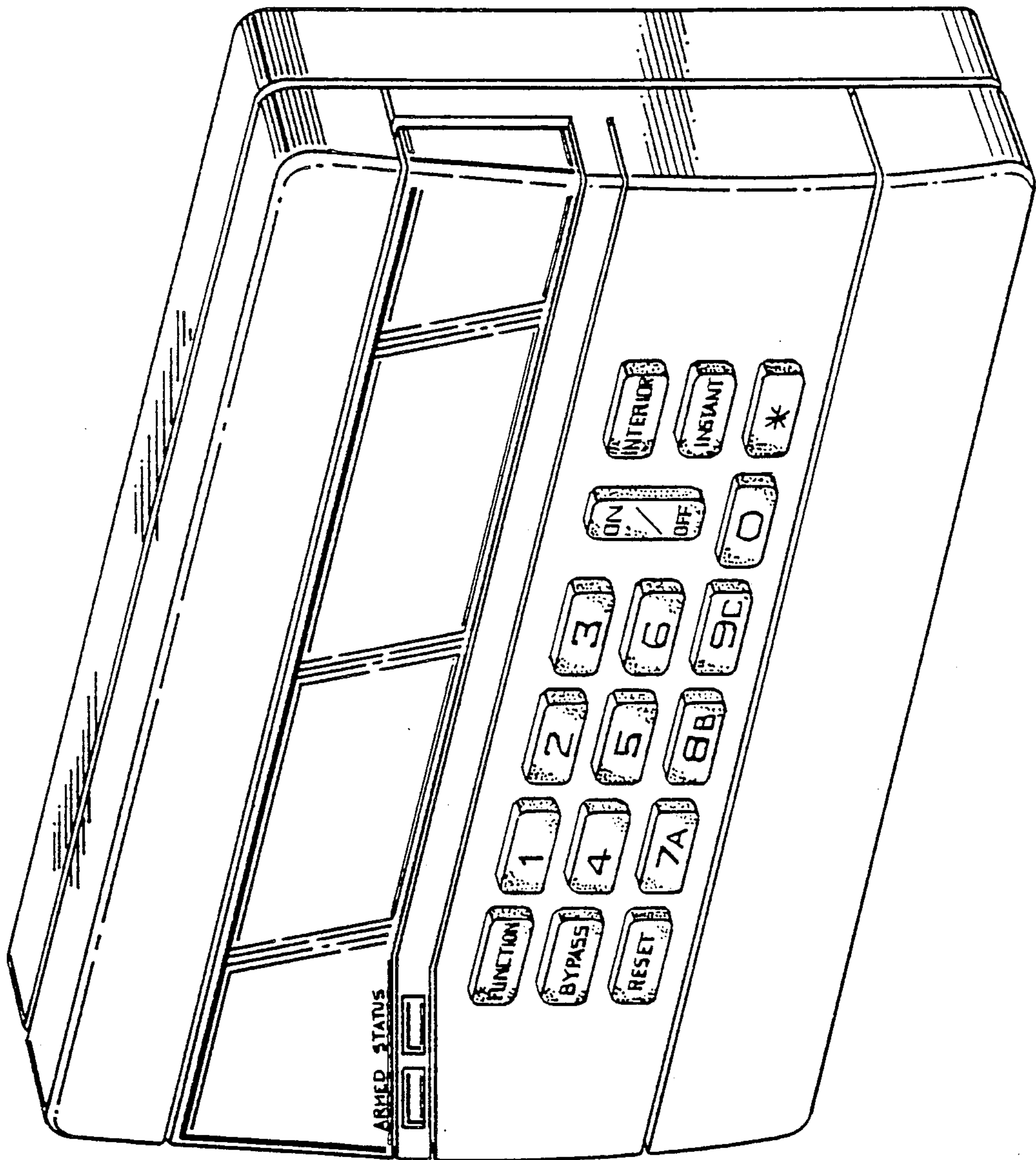

FIG. 6

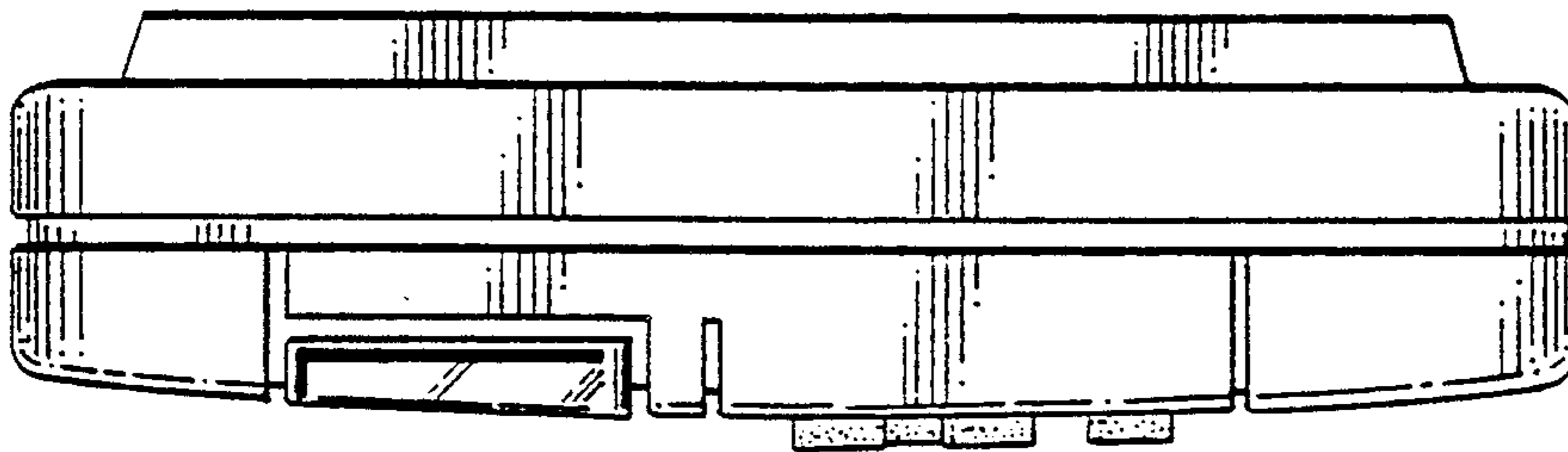

FIG. 8

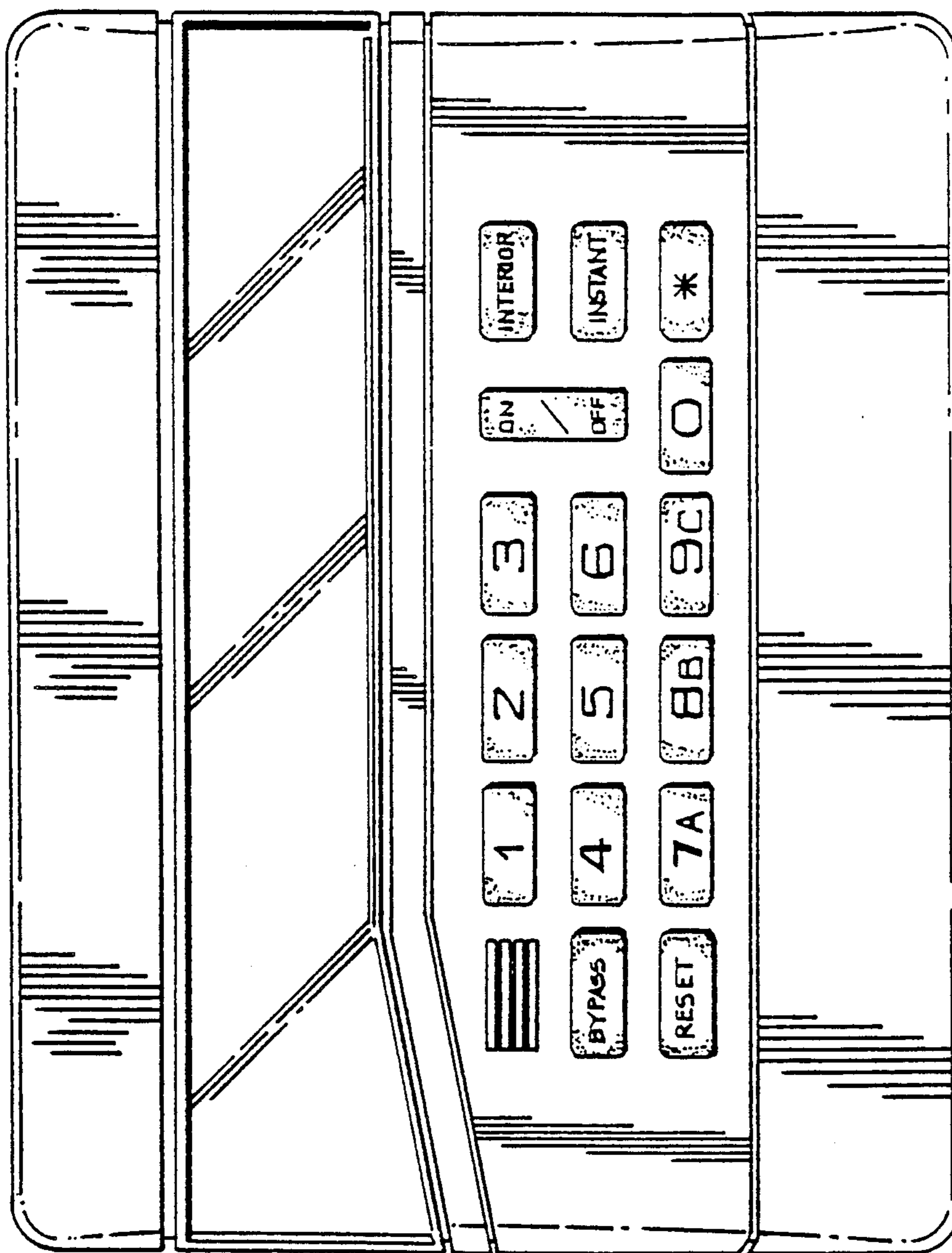

FIG. 7

FIG. 9

