



US00D326236S

United States Patent [19]

[11] Patent Number: **Des. 326,236**

Saito

[45] Date of Patent: **** May 19, 1992**

[54] **ELECTRONIC BALANCE**

705286 2/1987 Japan .

[75] Inventor: **Kiyoshi Saito, Tokyo, Japan**

705287 2/1987 Japan .

[73] Assignee: **Tokyo Electric Company Ltd., Tokyo, Japan**

OTHER PUBLICATIONS

[**] Term: **14 Years**

Digital Counting Scale DC-8000, Feb. 1979, cover page.

[21] Appl. No.: **29,466**

K-Tron Arizona, Inc. Apr. 1984, cover page.

[22] Filed: **Mar. 23, 1987**

Toledo Models 8422/325, 1986, cover page.

[30] Foreign Application Priority Data

Primary Examiner—Nelson C. Holtje

Sep. 22, 1986 [JP] Japan 61-37432

Assistant Examiner—Antoine D. Davis

Sep. 22, 1986 [JP] Japan 61-37433

Attorney, Agent, or Firm—Nilles & Nilles

[52] U.S. Cl. **D10/91**

[57] CLAIM

[58] Field of Search D10/83, 87, 91, 92,
D10/93, 82, 84, 85, 86, 88, 89, 90, 94, 95;
177/177, 238, 239, 240, 241, 243, DIG. 3

The ornamental design for electronic balance, as shown.

DESCRIPTION

[56] References Cited

U.S. PATENT DOCUMENTS

- D. 258,122 2/1981 Sinn D10/91
- D. 275,558 9/1984 Pearson D10/91
- D. 285,541 9/1986 Elkerbout D10/91
- D. 289,744 5/1987 Bungener D10/91

FIG. 1 is a top plan view of an electronic balance showing my new design;
 FIG. 2 is a front elevational view;
 FIG. 3 is a bottom plan view;
 FIG. 4 is a right side elevational view;
 FIG. 5 is a left side elevational view;
 FIG. 6 is a rear elevational view;
 FIG. 7 is a top, front, and left side perspective view;
 FIG. 8 is a top, front, and left side perspective view, the display screen showing typical indica; and,
 FIG. 9 is a top, front, and left side perspective view of another embodiment of my new design of FIGS. 1-8.

FOREIGN PATENT DOCUMENTS

- 633421 6/1984 Japan .
- 633442 6/1984 Japan .

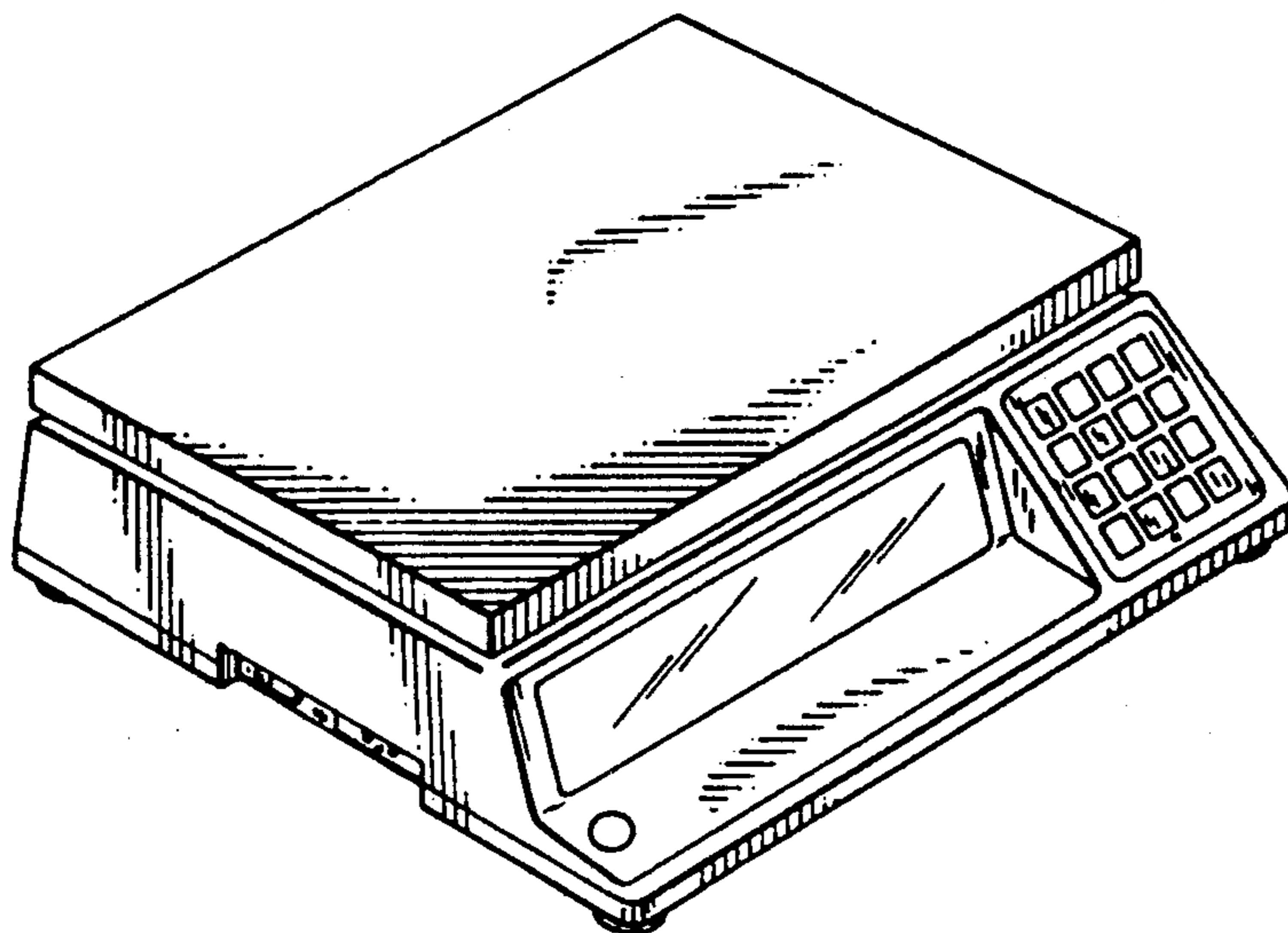

FIG. 1

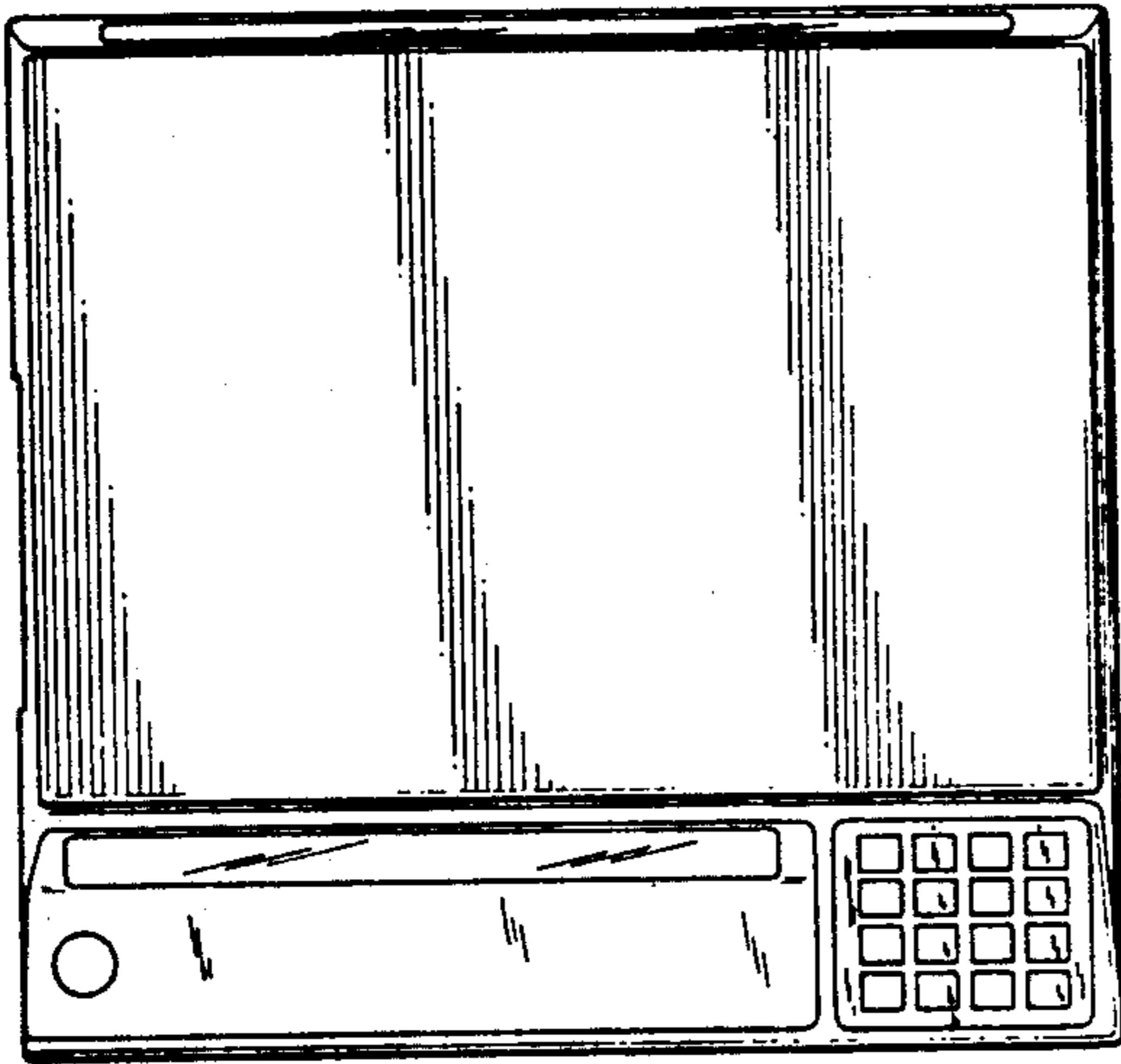

FIG. 2

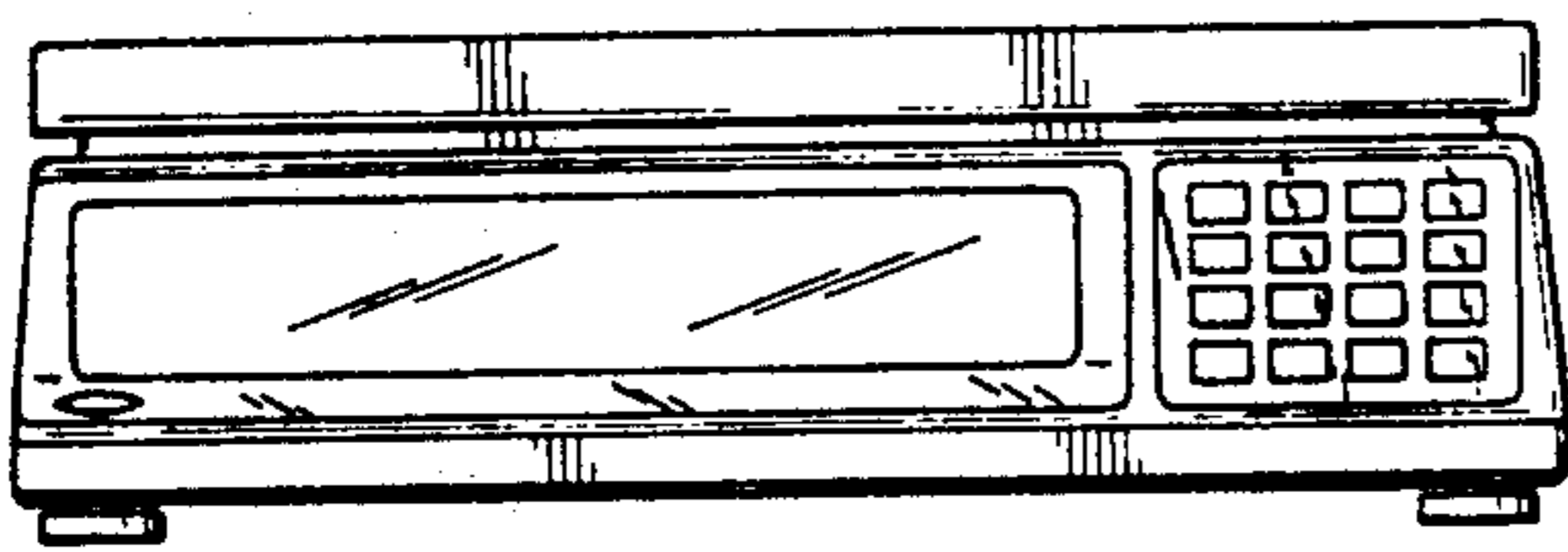

FIG. 3

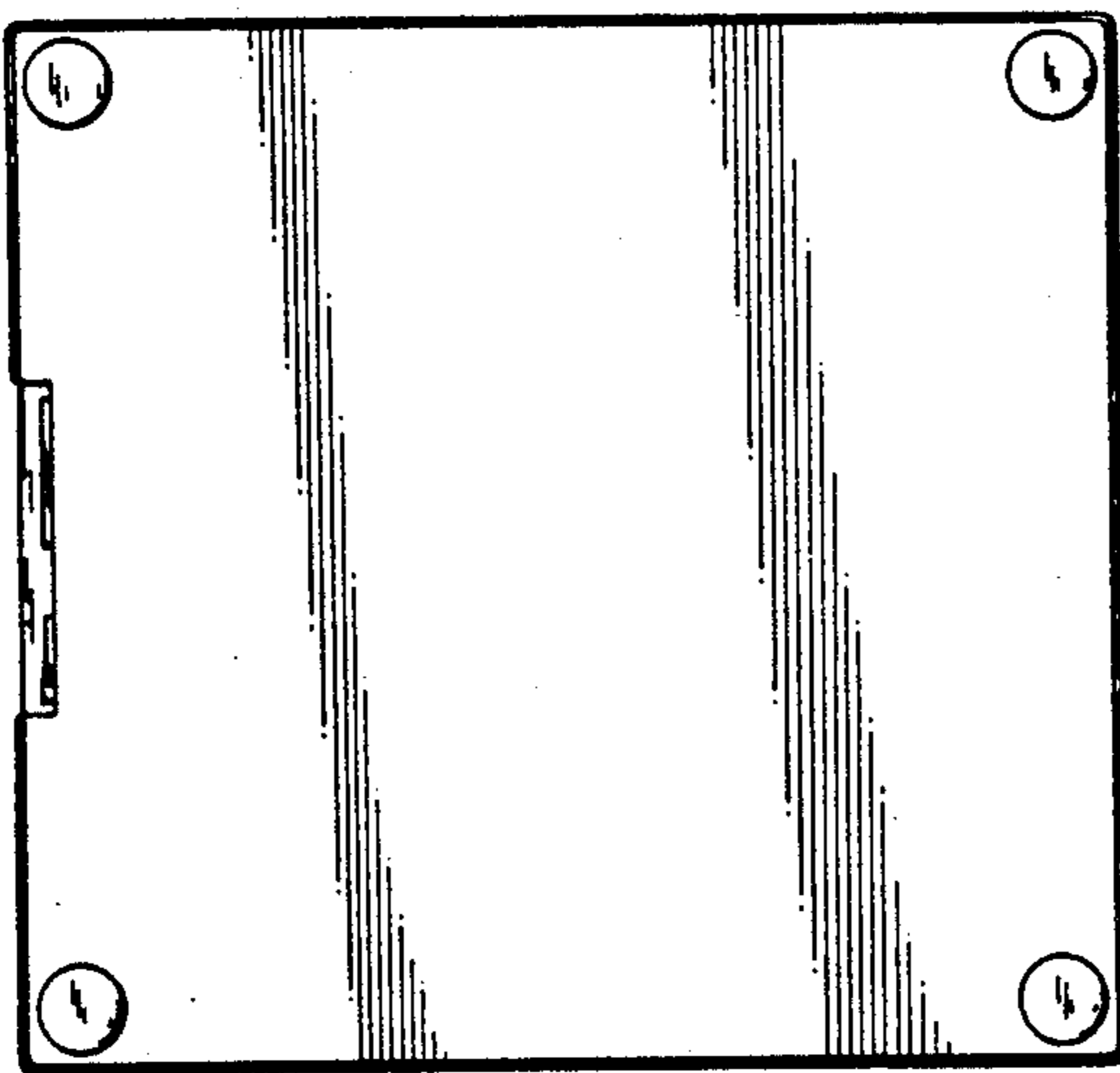

FIG. 4

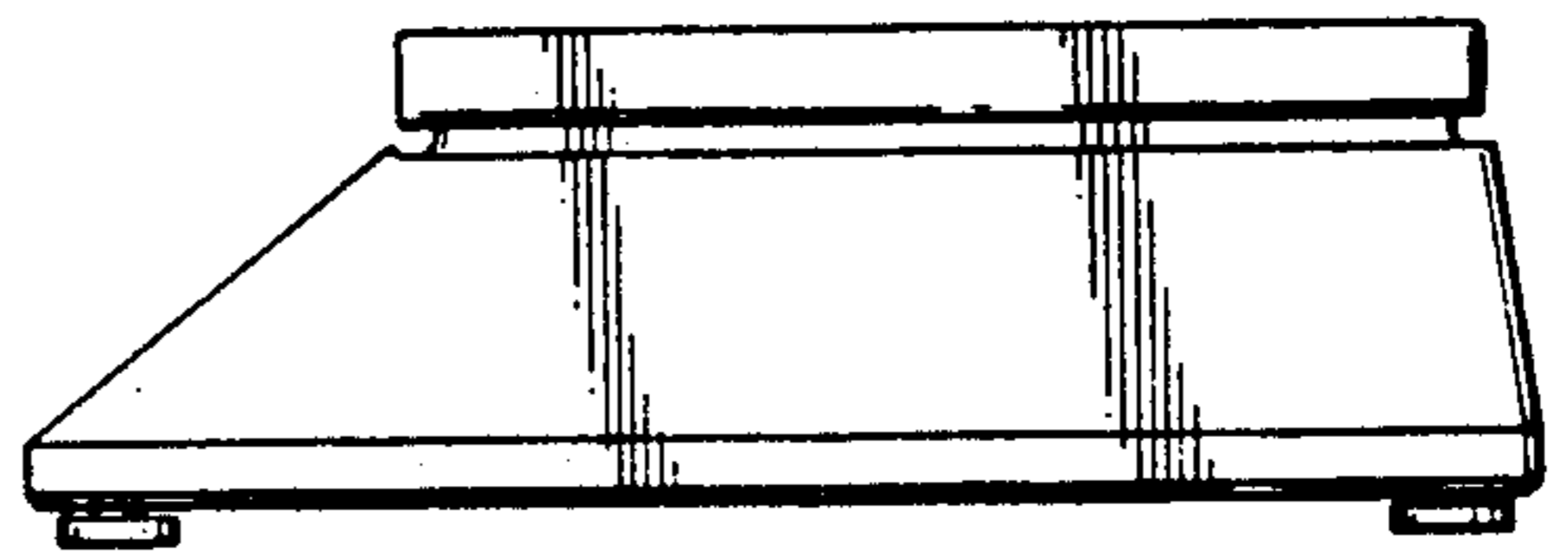

FIG. 5

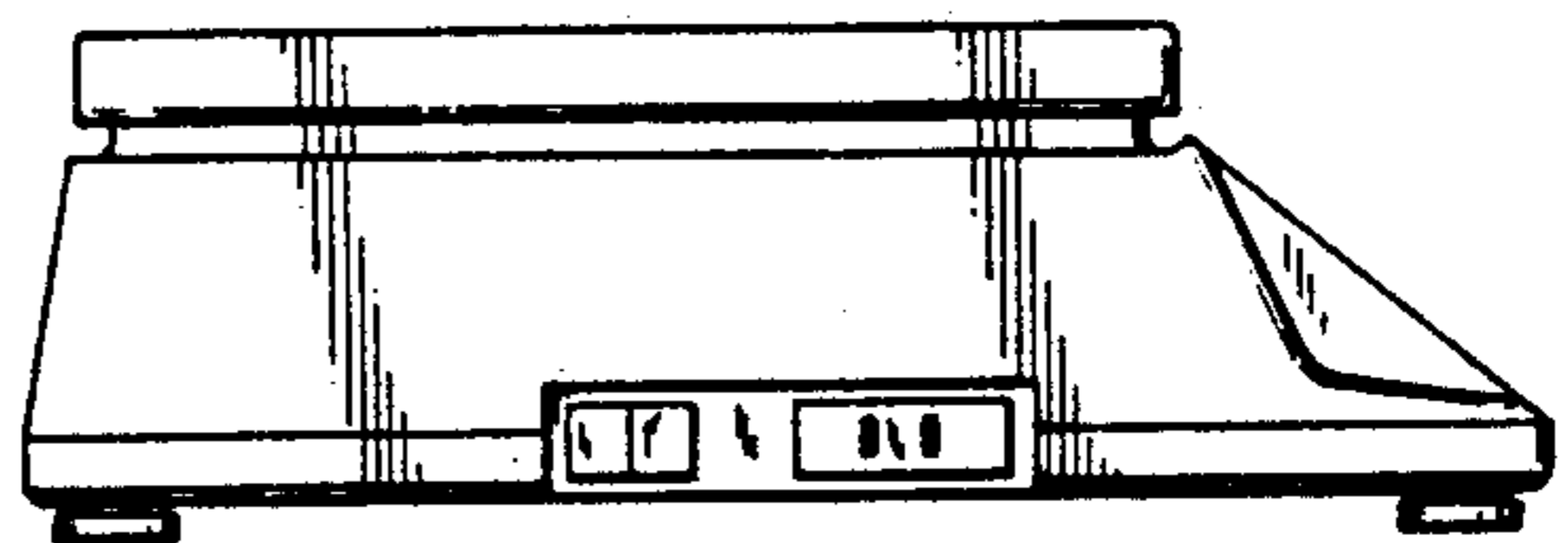

FIG. 6

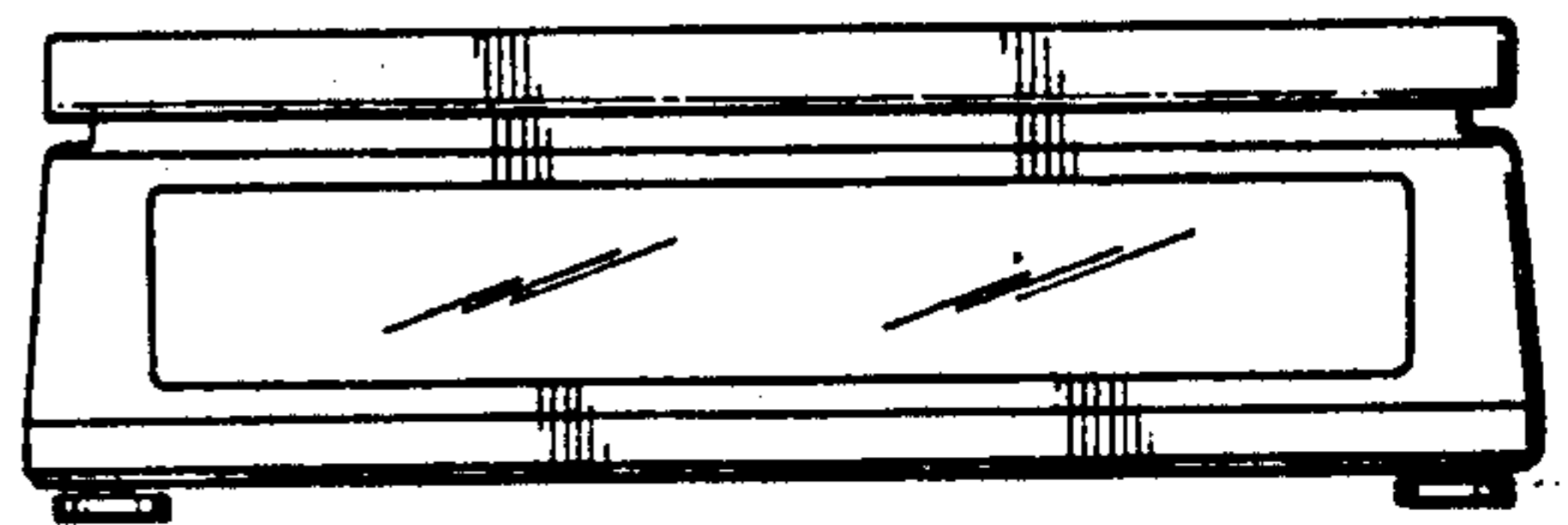

FIG. 7

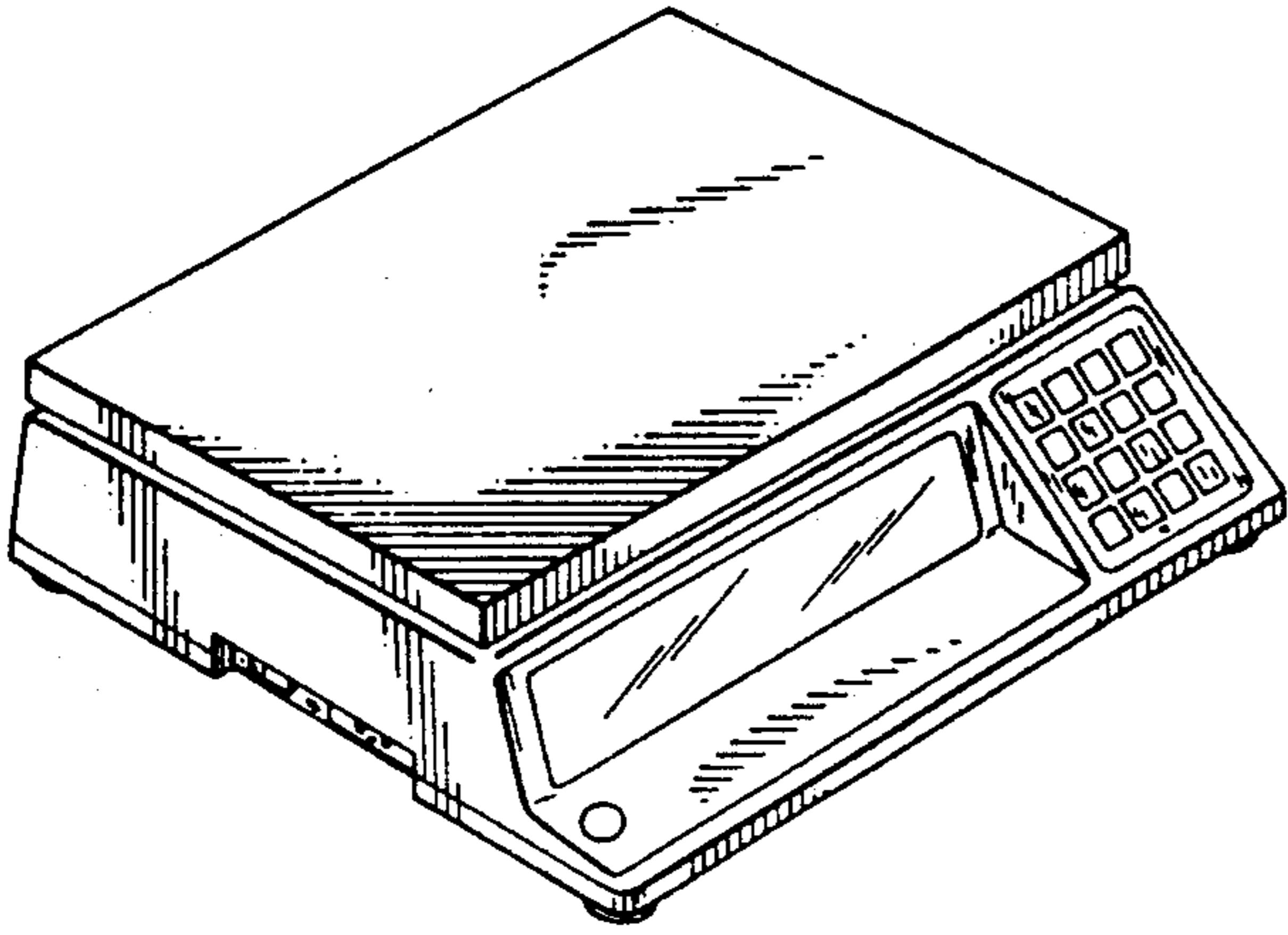

FIG. 8

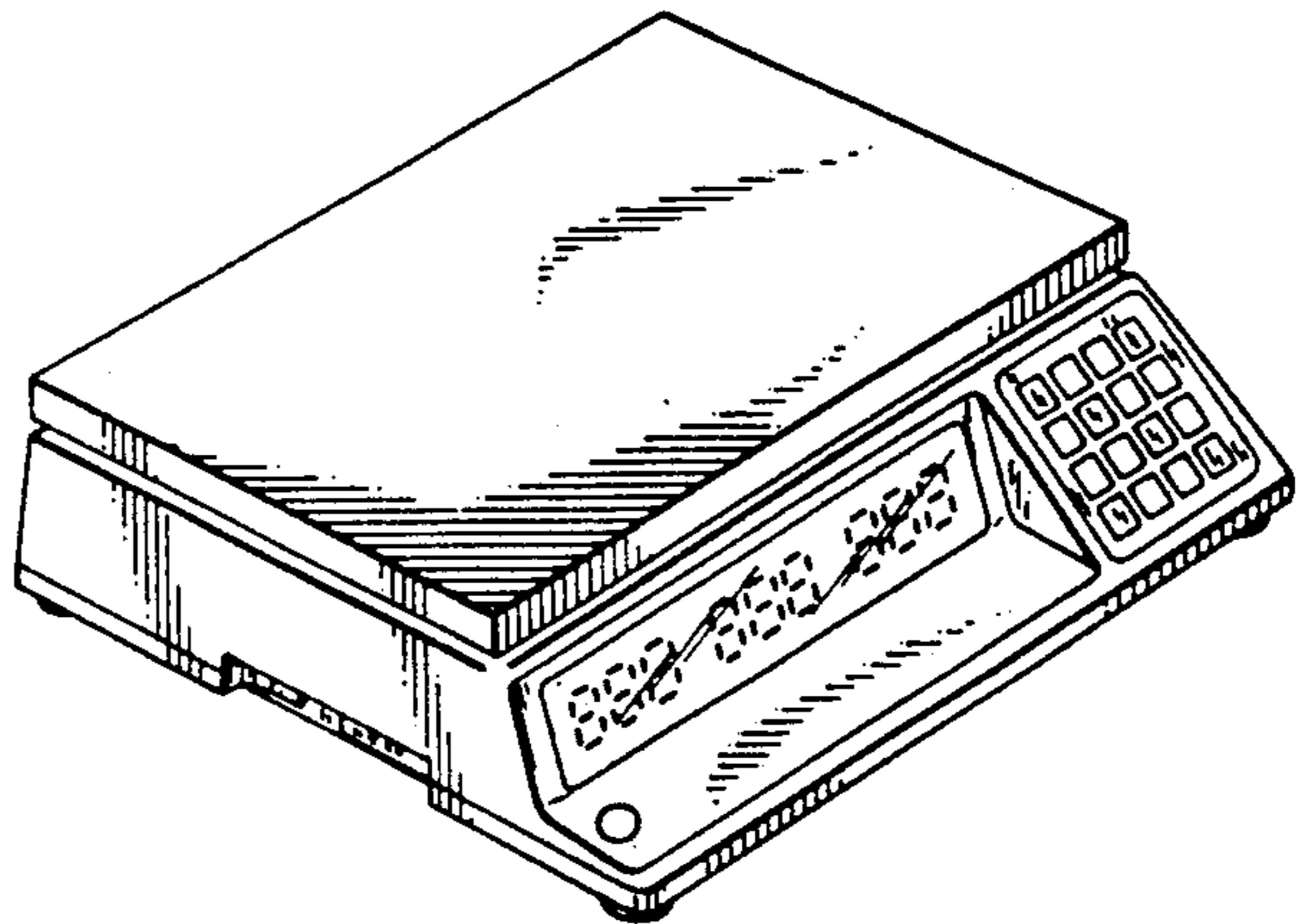

FIG. 9

