



US00D326220S

United States Patent [19] Hampshire

[11] Patent Number: Des. 326,220

[45] Date of Patent: ** May 19, 1992

[54] **HOLDER FOR THE HAFT OF A BROOM,
MOP OR SIMILAR ARTICLE**

[75] Inventor: **James Hampshire**, Solon, Ohio

[73] Assignee: **InterDesign Inc.**, Solon, Ohio

[**] Term: **14 Years**

[21] Appl. No.: **650,652**

[22] Filed: **Feb. 5, 1991**

[52] U.S. Cl. **D8/373**

[58] Field of Search 248/316.3, 113, 110;
D8/373, 394, 396

2,616,143	11/1952	Folkner	248/316.3
2,661,920	12/1953	Gochenour	248/316.3 X
2,898,657	8/1959	Longfellow	24/249
2,913,830	1/1947	Menzel	24/316.3 X

FOREIGN PATENT DOCUMENTS

528998	6/1954	Belgium	248/110
2624855	12/1977	Fed. Rep. of Germany	248/110
339478	6/1904	France	248/113
1190273	10/1959	France	248/110
121030	3/1943	Sweden	248/113
306327	6/1955	Switzerland	248/113

Primary Examiner—Horace B. Fay, Jr.

Attorney, Agent, or Firm—D. Peter Hochberg; Mark Kusner; Louis J. Weisz

[56] **References Cited**

U.S. PATENT DOCUMENTS

D. 136,004	7/1943	Allred	D8/373
189,282	4/1877	Strobridge	248/316.3 X
194,446	8/1877	Lash	248/113
D. 196,291	9/1963	McCarthy	D8/373
D. 199,518	11/1964	Sanders et al.	D8/373
D. 217,225	4/1970	Fitzsimmons	D8/373
D. 301,976	7/1989	Greenhut et al.	D8/373
429,781	6/1890	Shimer	248/316.3 X
441,266	11/1890	Volz	248/110
550,085	2/1896	Frantz	248/113
602,243	4/1898	Rybold	248/113
893,347	7/1908	Morell	248/113
1,550,549	8/1925	Langlotz	248/113
1,606,487	11/1926	Wamsley	248/113
1,864,817	6/1932	Hart	248/316.3 X
1,883,808	10/1932	Meggenhofen et al.	248/113
2,488,664	11/1949	Gruber	24/249

[57] **CLAIM**

The ornamental design for a haft of a broom, mop or similar article, as shown and described.

DESCRIPTION

FIG. 1 is an isometric view of a holder for the haft of a broom, mop or similar article;

FIGS. 2 and 3 are respectively front and rear elevational view thereof;

FIGS. 4 and 5 are respectively left and right elevational view thereof; and,

FIGS. 6 and 7 are respectively top and bottom plan views thereof.

The broken line showing of the haft of a broom, mop or similar article in all figures is for illustrative purposes only and forms no part of the claimed design.

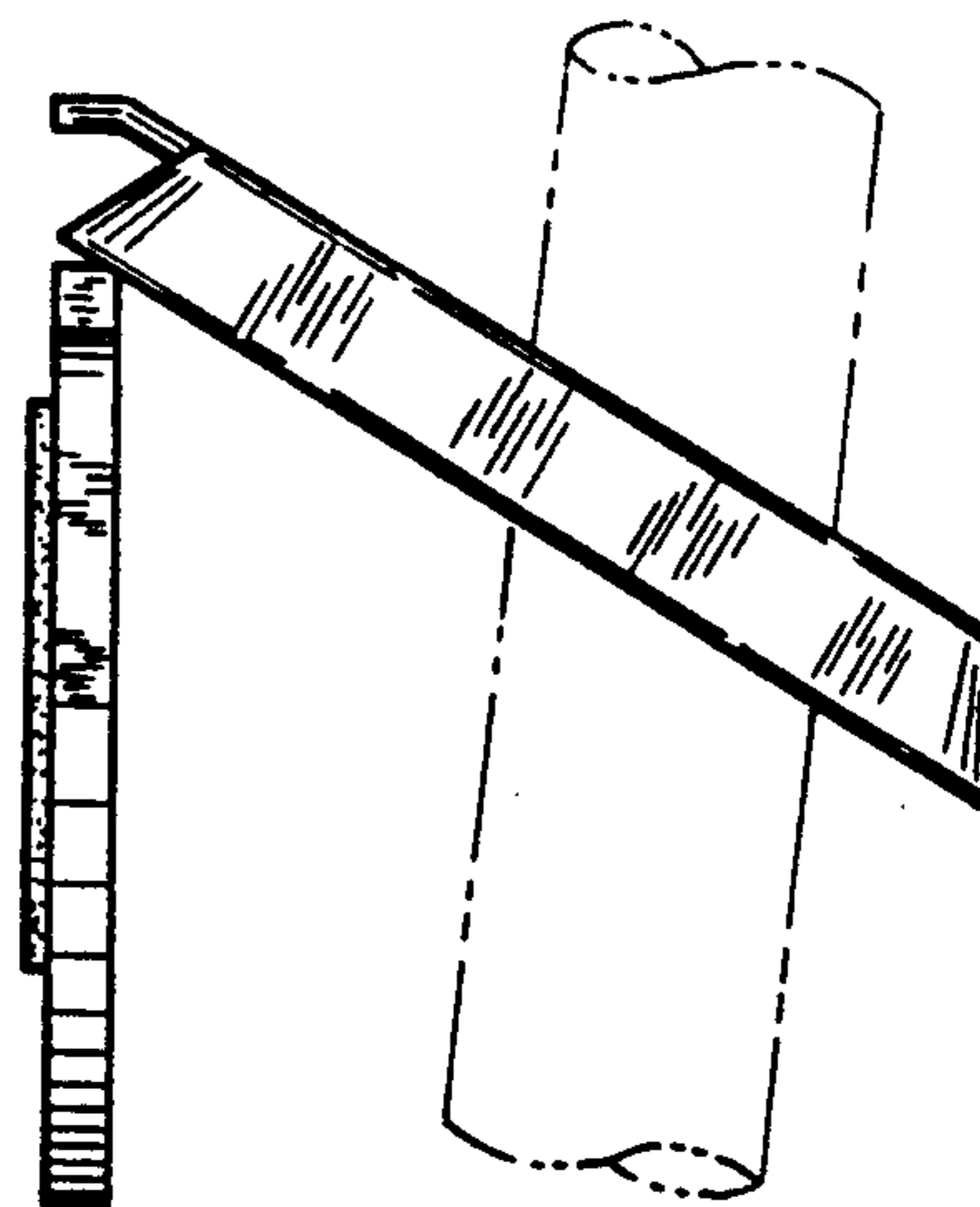
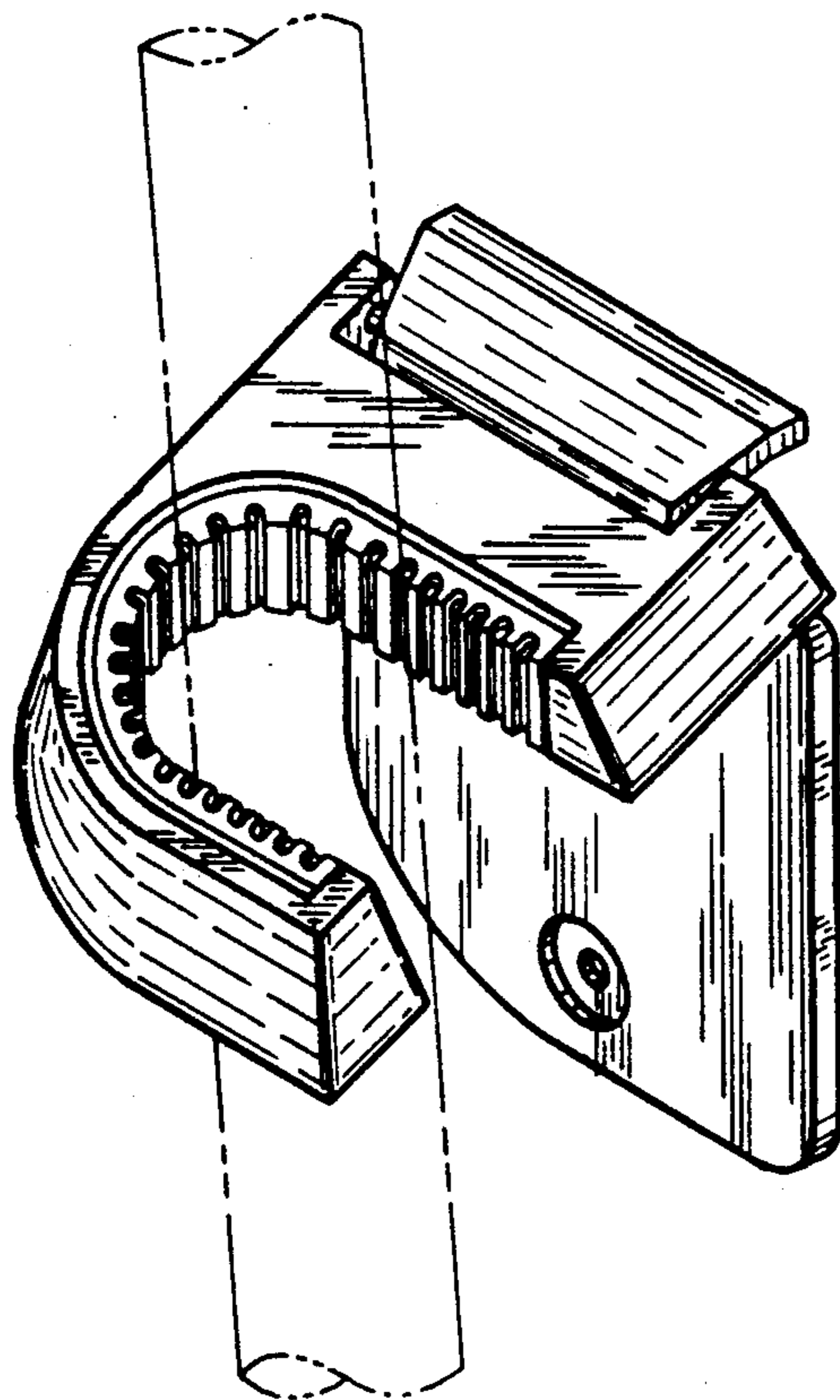

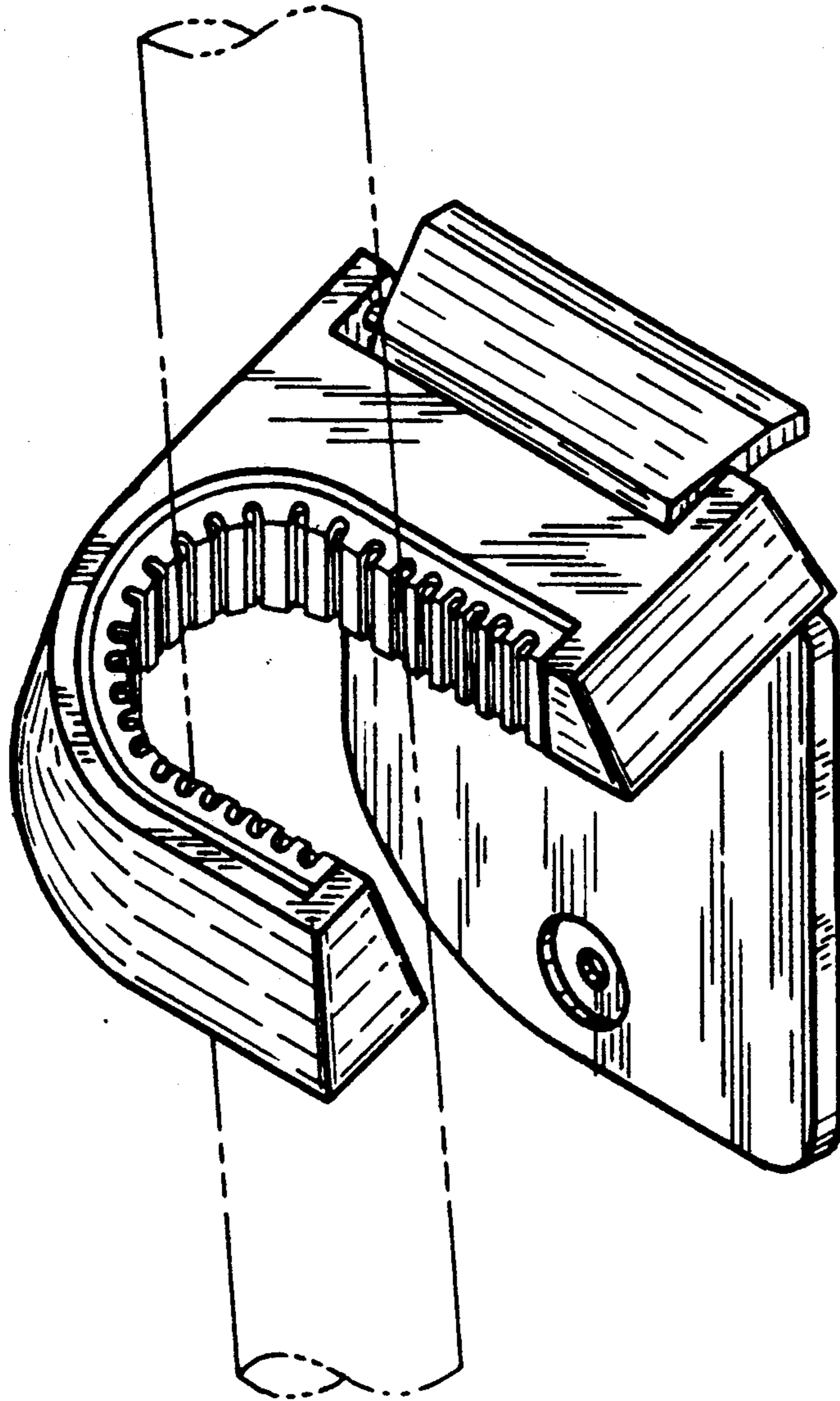

FIG. 1

FIG. 2

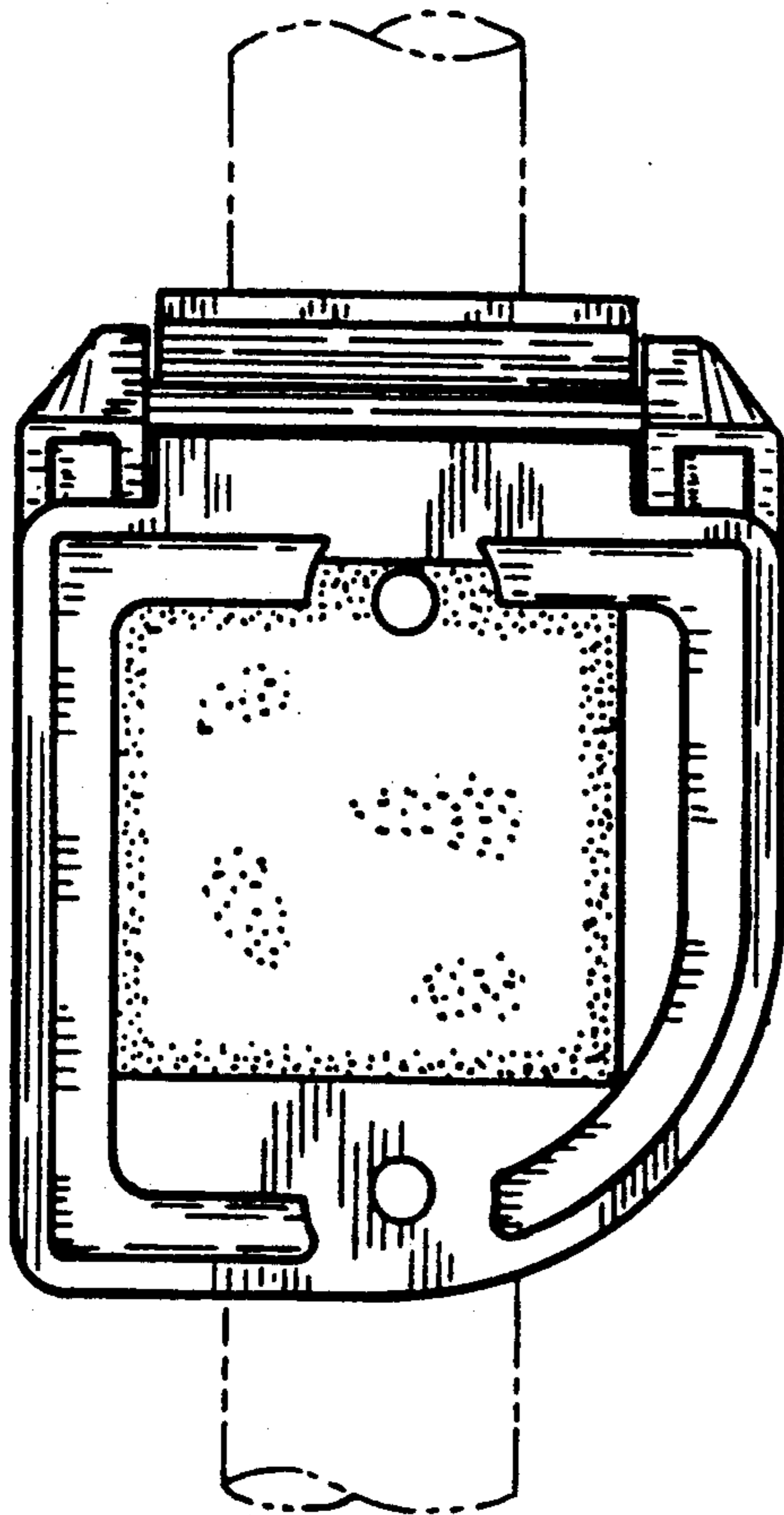
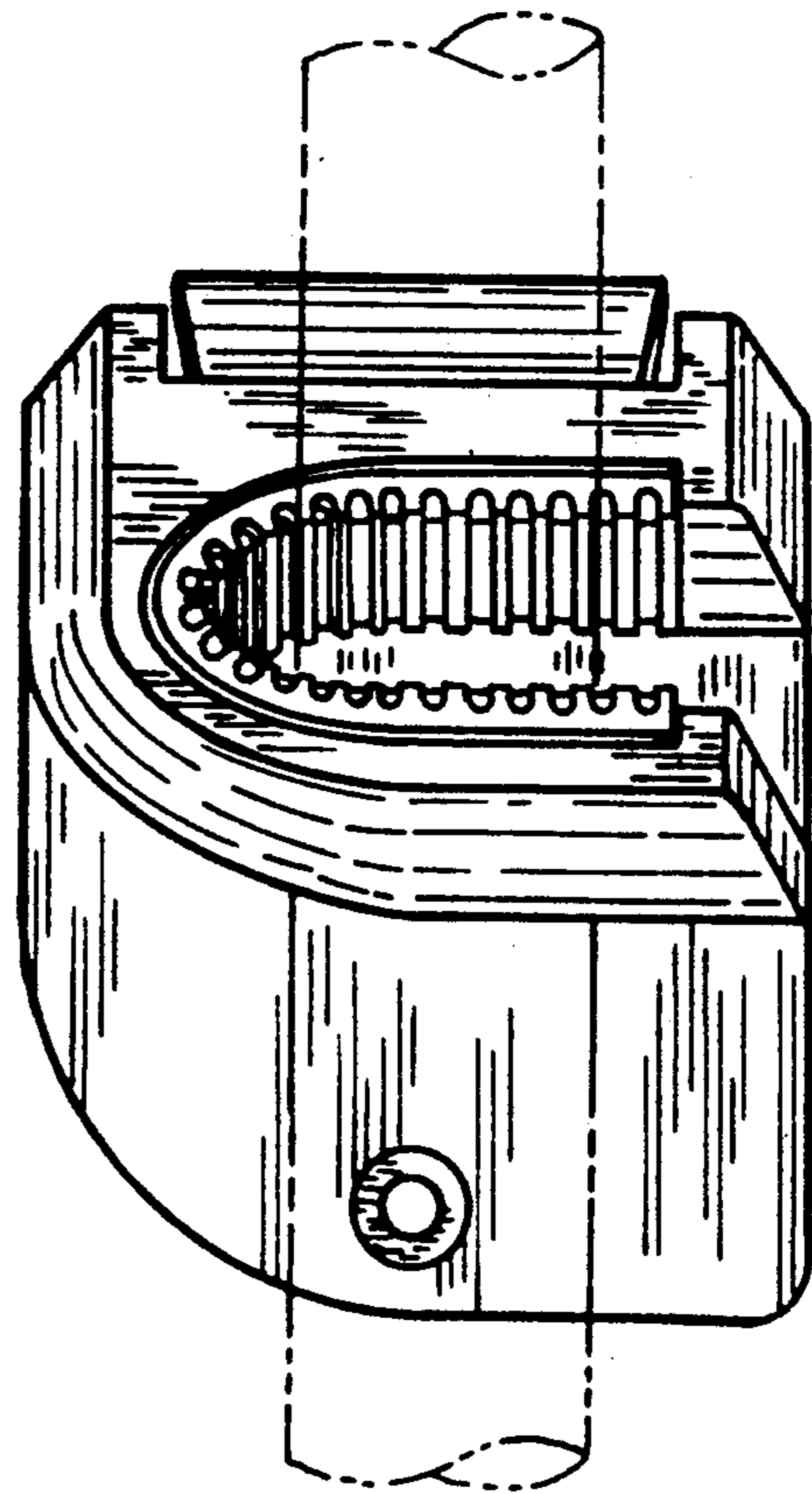

FIG. 3

FIG. 4

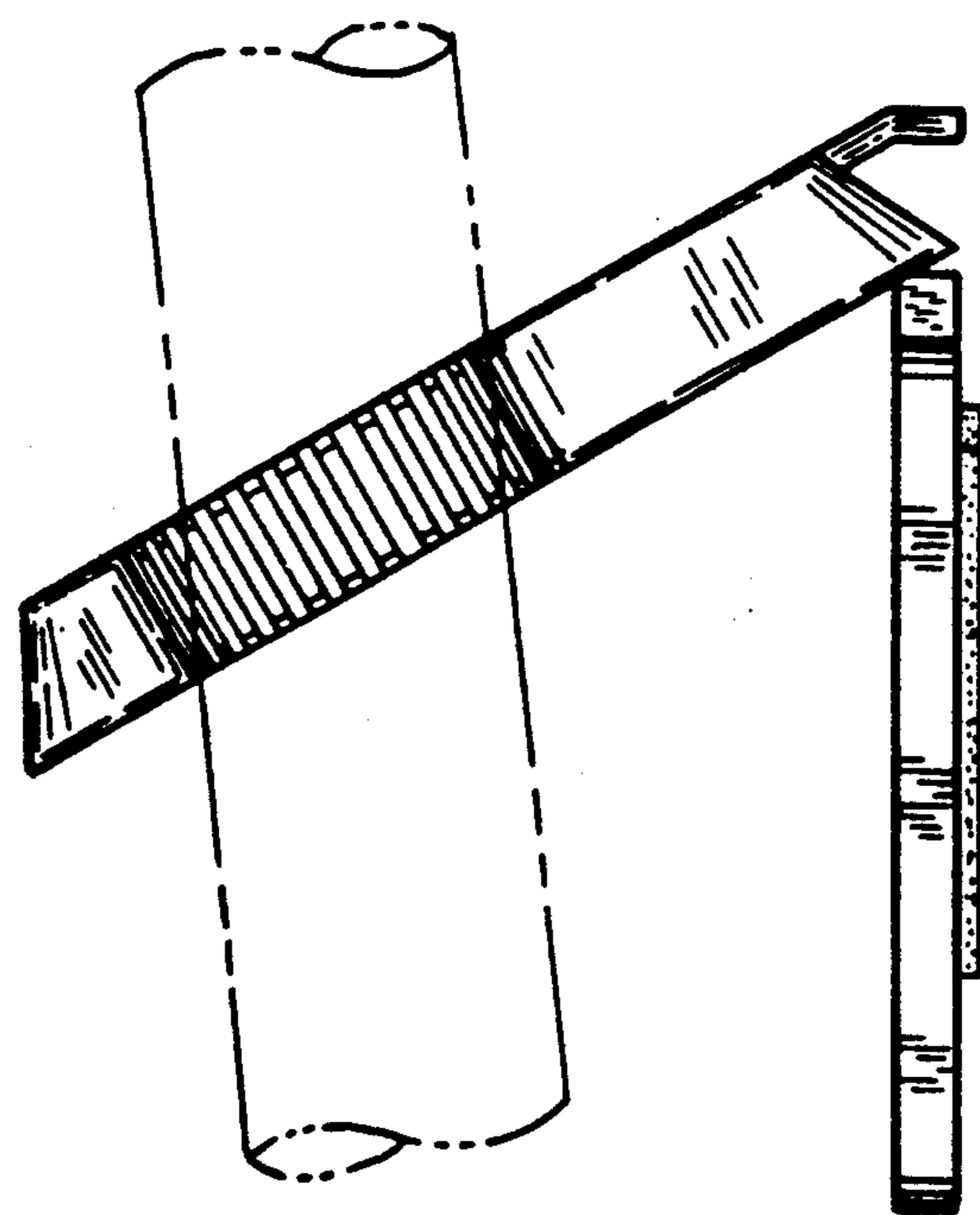
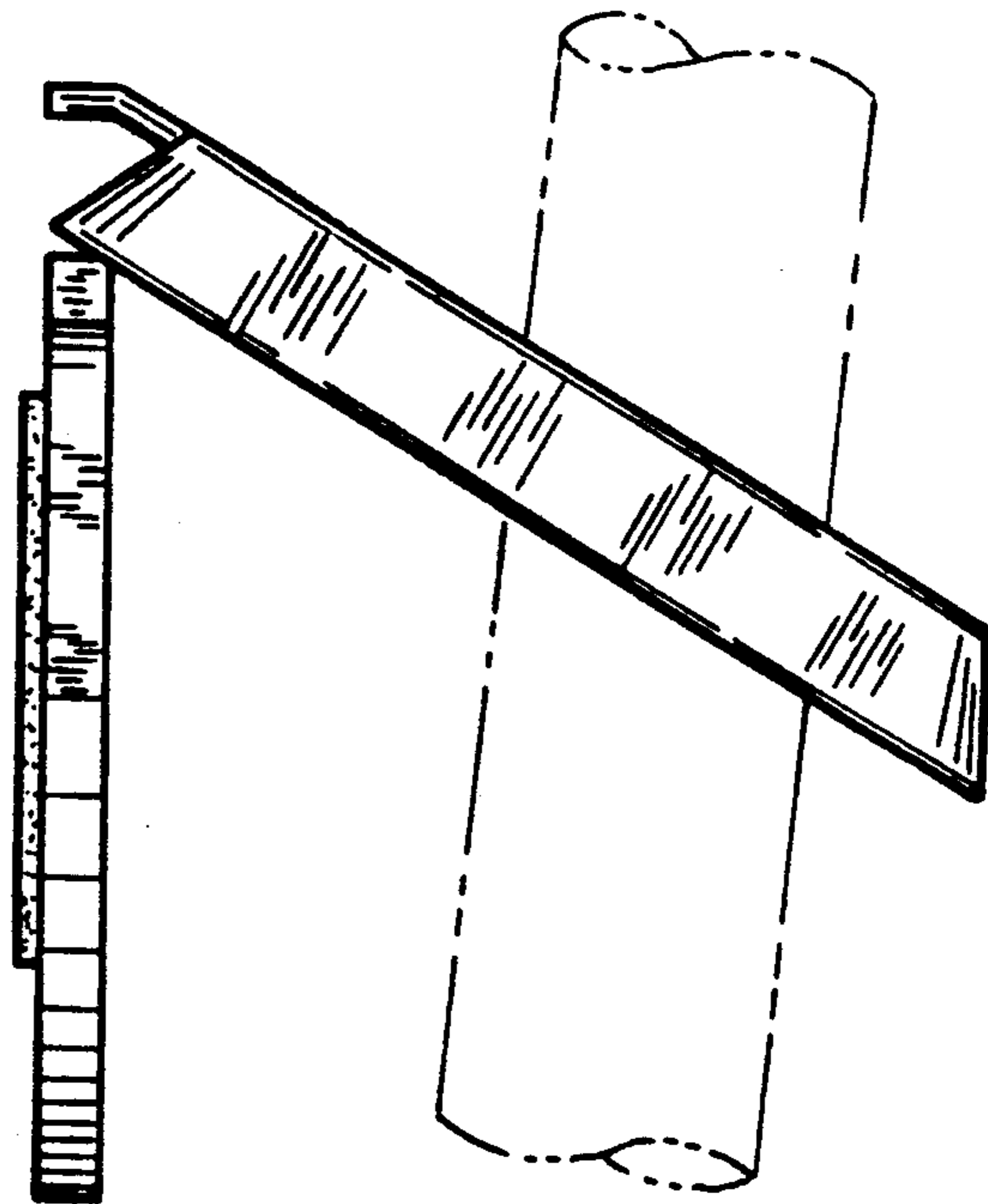

FIG. 5

FIG. 6

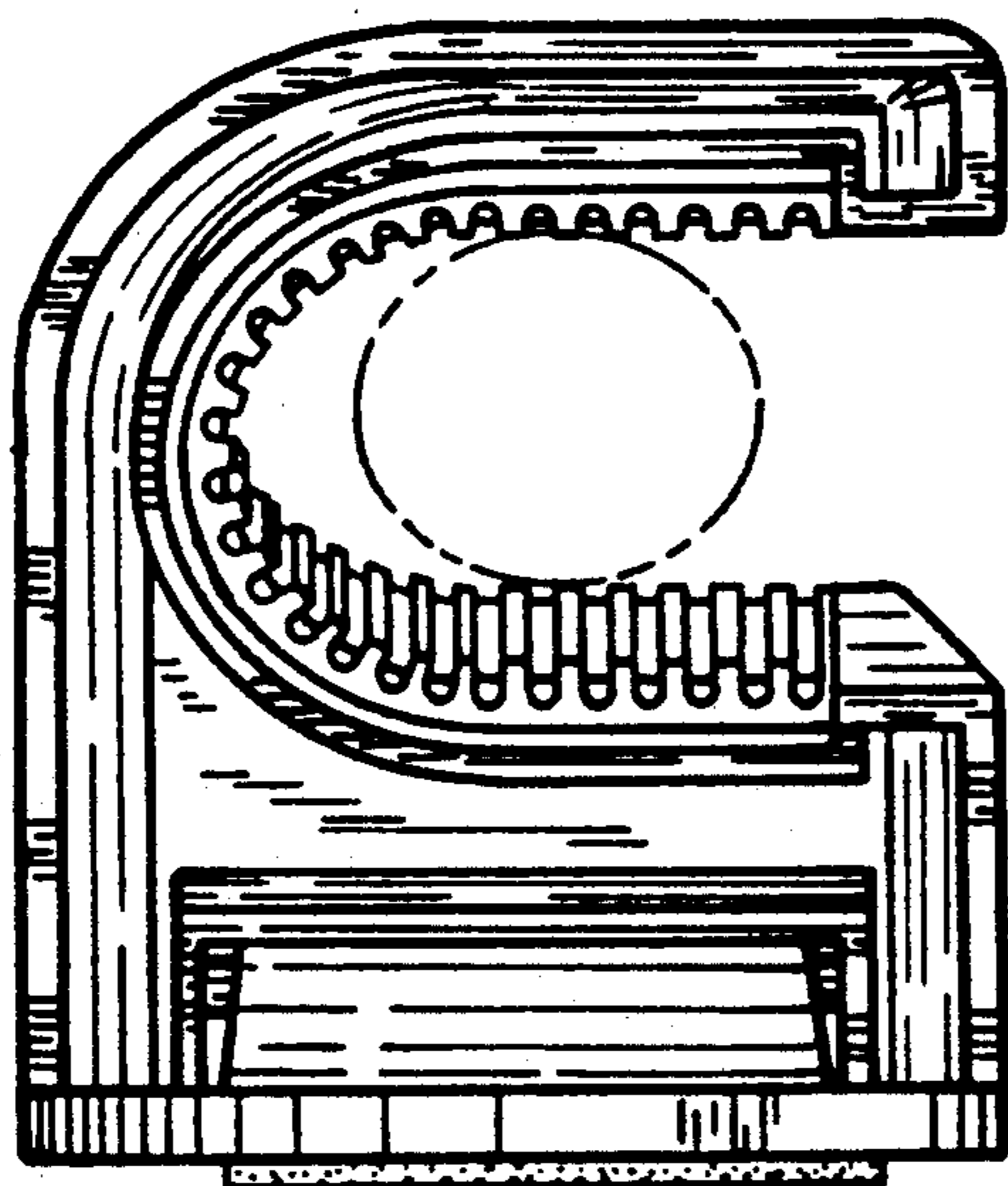
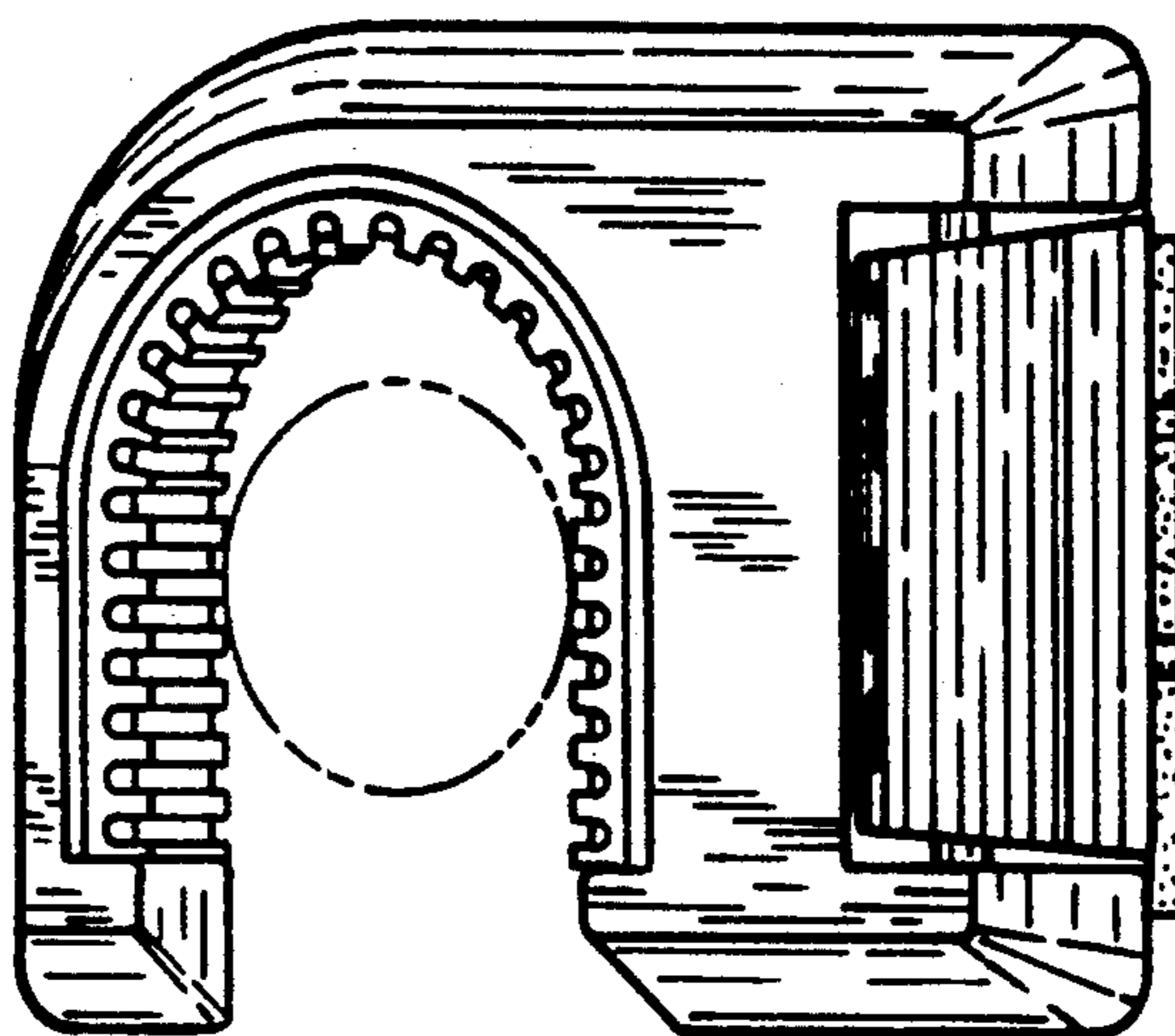

FIG. 7