



US00D326174S

United States Patent [19]

[11] Patent Number: **Des. 326,174**

McDonald

[45] Date of Patent: **** May 12, 1992**

[54] TRASH CONTAINER CART

4,811,968 3/1989 Bolden 280/47.26

[76] Inventor: **Kenneth A. McDonald**, Rte. 3, Box 145-A, Gainesville, Tex. 76240

Primary Examiner—Kay H. Chin
Attorney, Agent, or Firm—Allen A. Meyer, Jr.

[**] Term: **14 Years**

[57] **CLAIM**

[21] Appl. No.: **383,987**

The ornamental design for a trash container cart, as shown and described.

[22] Filed: **Jul. 24, 1989**

[52] U.S. Cl. **D34/17; D34/5**

[58] Field of Search **D34/1, 5; 280/47.26, 280/47.19; 248/DIG. 7, 98, 129; 220/908, 909, 910**

DESCRIPTION

FIG. 1 is a top perspective view of a trash container cart showing my new design;
FIG. 2 is a front elevational view thereof;
FIG. 3 is a side elevational view thereof, the opposite side elevational view being a mirror image of that shown;
FIG. 4 is a rear elevational view thereof;
FIG. 5 is a top plan view thereof; and,
FIG. 6 is a bottom plan view thereof.

[56] **References Cited**

U.S. PATENT DOCUMENTS

- D. 305,171 12/1989 Marini D34/6
- 3,111,333 11/1963 Marini et al. D34/5
- 3,280,988 10/1966 Bennett 280/47.26

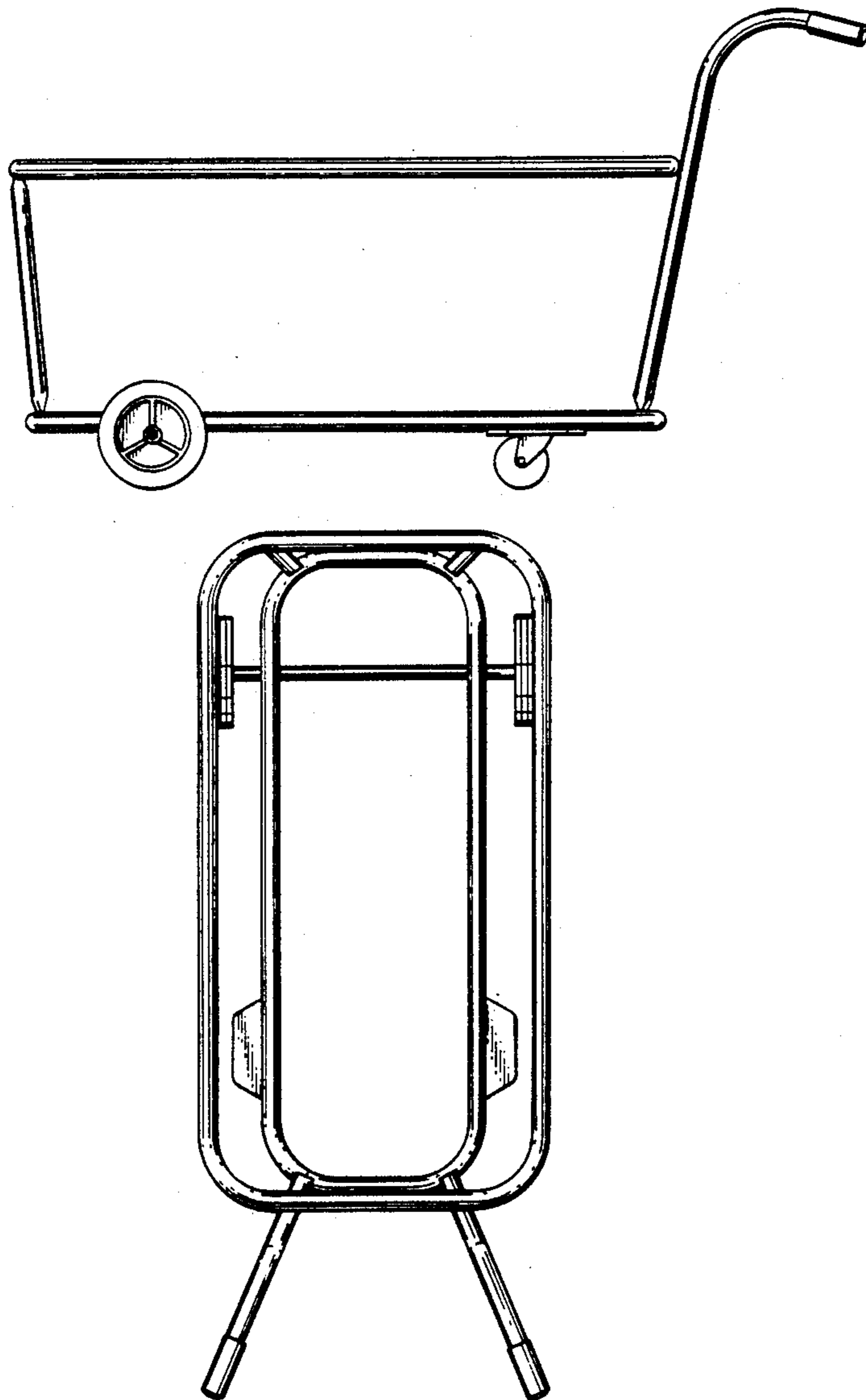

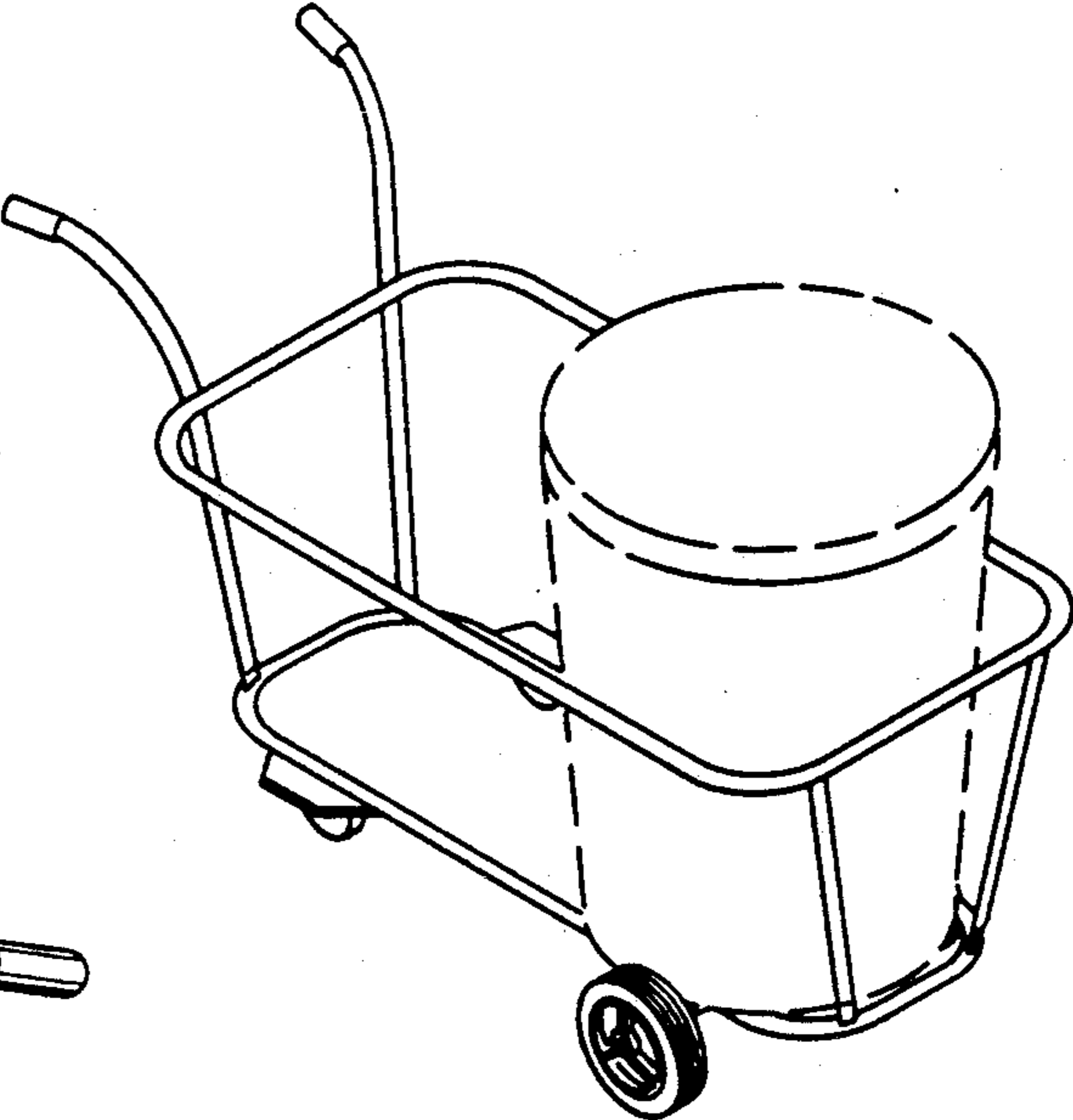

FIG. 1

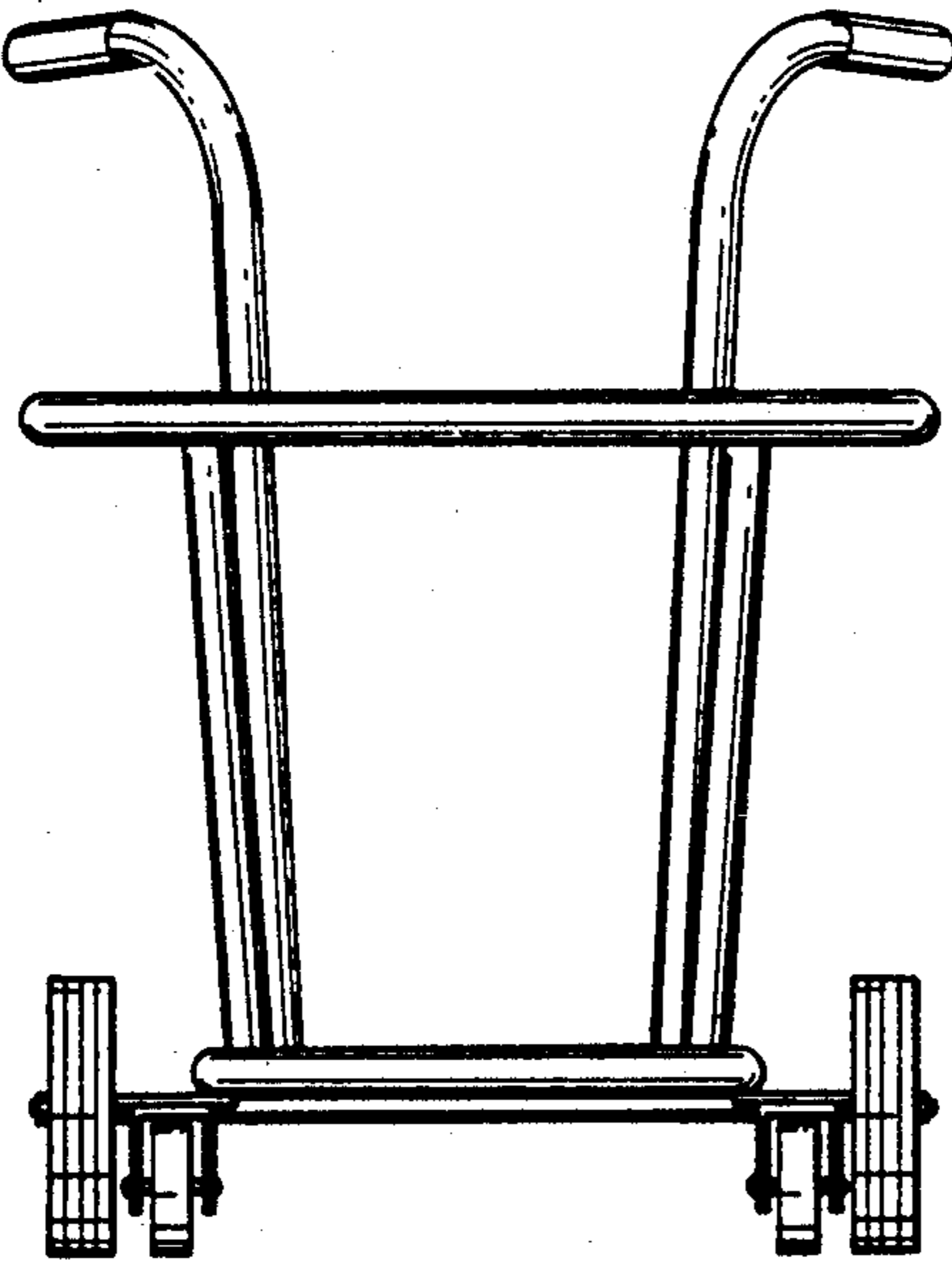

FIG. 2

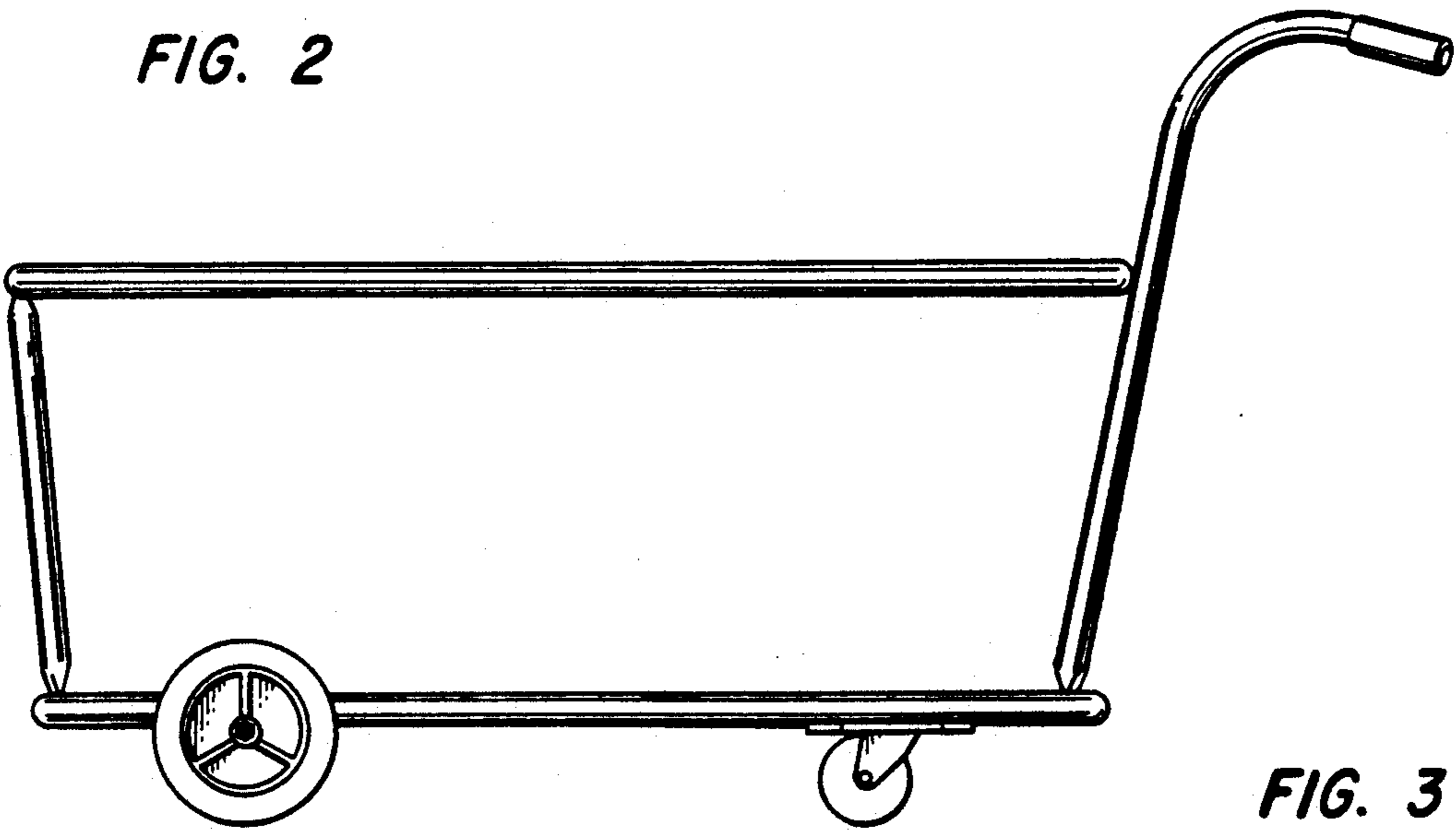

FIG. 3

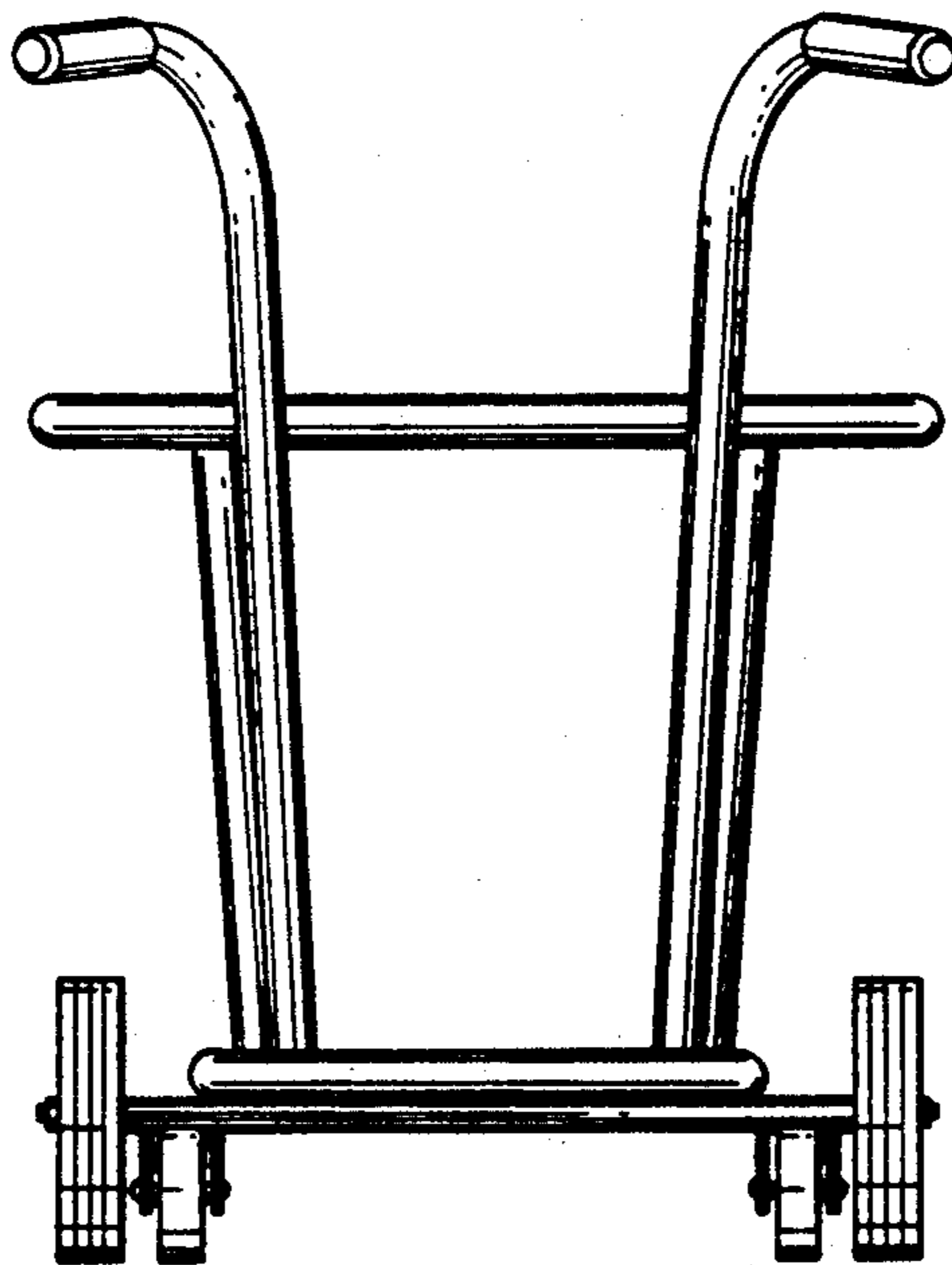

FIG. 4

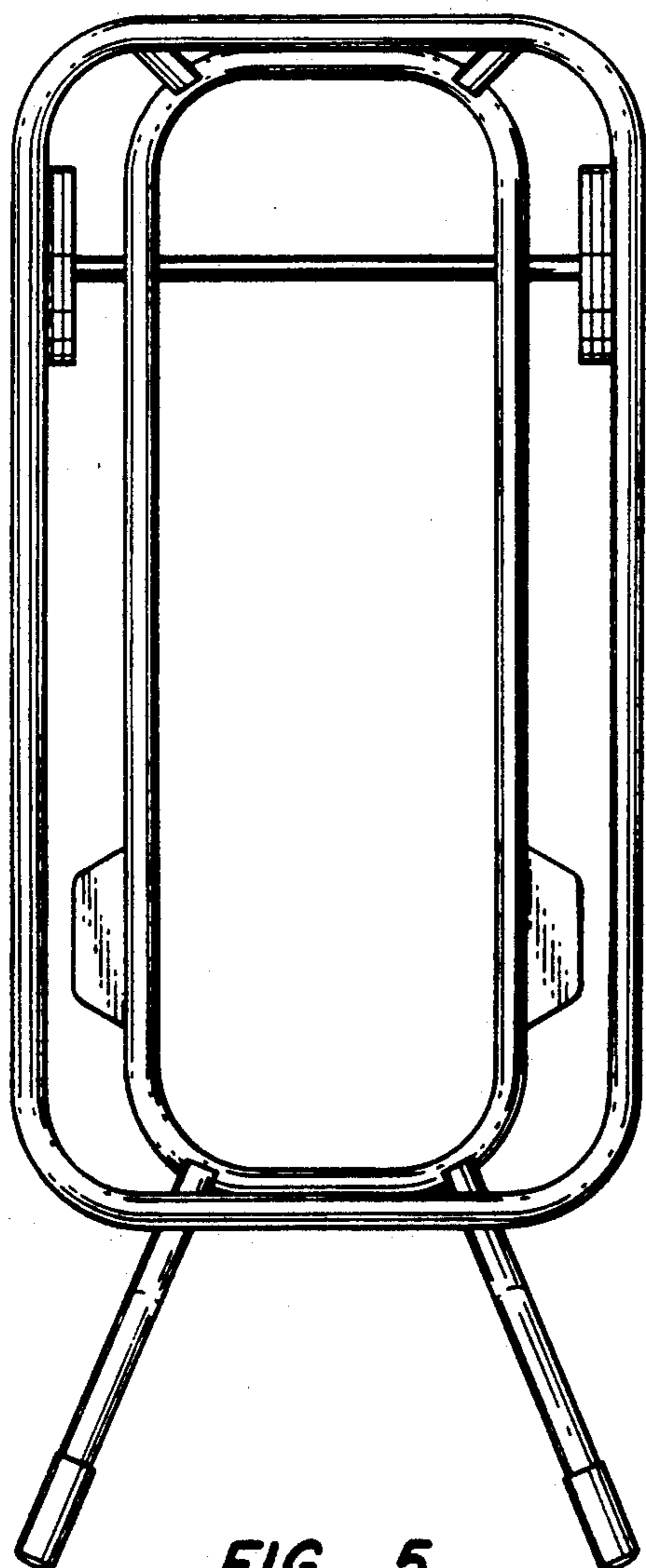

FIG. 5

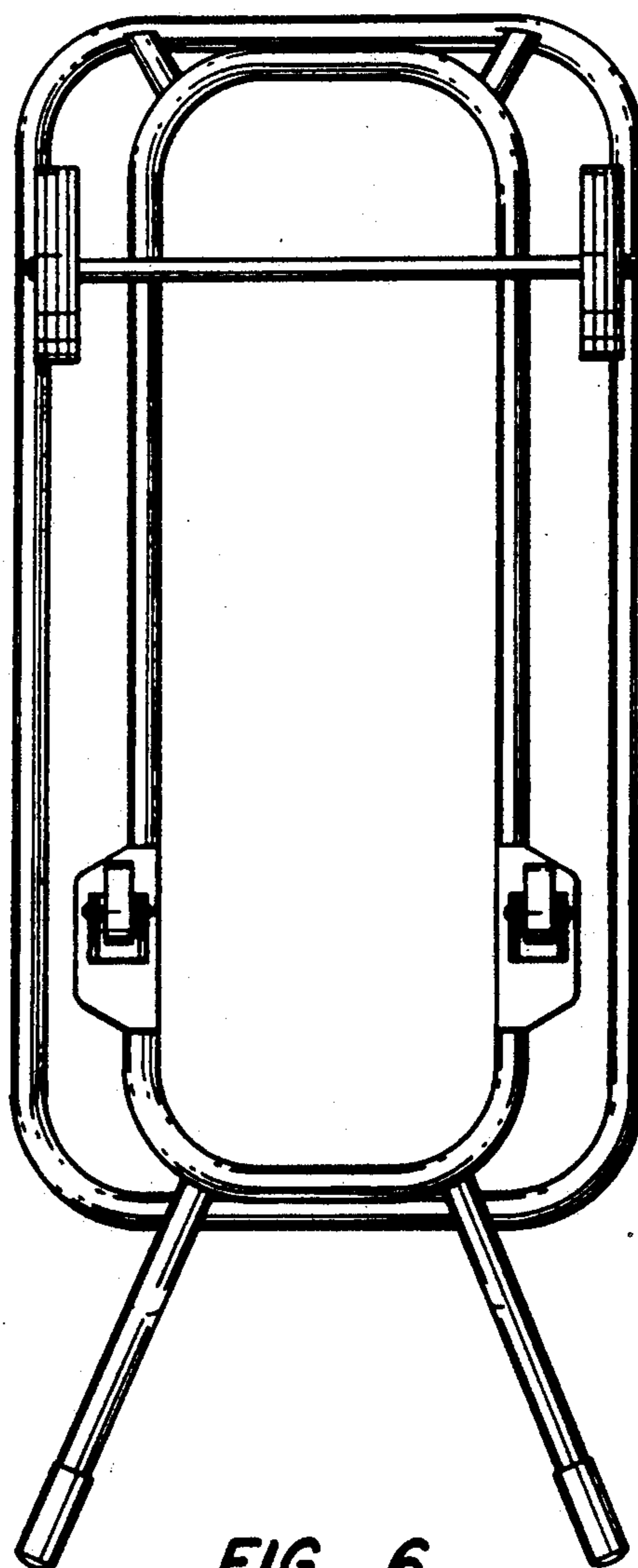

FIG. 6