



US00D326113S

United States Patent [19]

[11] Patent Number: **Des. 326,113**

Galante

[45] Date of Patent: **** May 12, 1992**

[54] **MULTIPURPOSE ORGANIZER**

[76] Inventor: **Carl J. Galante**, P.O. Box 1359,
Sanibel, Fla. 33957

[**] Term: **14 Years**

[21] Appl. No.: **208,025**

[22] Filed: **Jun. 17, 1988**

[52] U.S. Cl. **D19/78; D19/75;**
D19/85; D34/43

[58] Field of Search **D19/65, 75, 35, 77,**
D19/78; D3/78; D34/40, 43; 206/214, 371,
449; 211/69.1-69.9

[56] **References Cited**

U.S. PATENT DOCUMENTS

D. 28,416	3/1898	Akin	D19/78
D. 221,276	7/1971	Rehrig	D34/43
D. 231,331	4/1974	Stauble	D34/43
D. 286,339	10/1986	van Berne et al.	D34/43
D. 289,181	4/1987	Solomon	D34/43 X
D. 306,227	2/1990	Ross	D34/40 X

FOREIGN PATENT DOCUMENTS

2023102 12/1979 United Kingdom 206/449

Primary Examiner—Bruce W. Dunkins
Assistant Examiner—Martha Thompson
Attorney, Agent, or Firm—Richard C. Litman

[57] **CLAIM**

The ornamental design for a multipurpose organizer, as shown and described.

DESCRIPTION

FIG. 1 is a front perspective view of a multi-purpose organizer showing my new design;
FIG. 2 is a top plan view thereof;
FIG. 3 is a bottom plan view thereof;
FIG. 4 is a side elevational view thereof, the opposite side elevational view being a mirror image;
FIG. 5 is a front elevational view thereof;
FIG. 6 is a rear elevational view thereof;
FIG. 7 is a front perspective view of a second embodiment of my new design;
FIG. 8 is a top plan view of FIG. 7;
FIG. 9 is a bottom plan view of FIG. 7;
FIG. 10 is a front elevational view of FIG. 7, the rear elevational view being a mirror image; and,
FIG. 11 is a side elevational view of FIG. 7, the opposite side being a mirror image thereof.

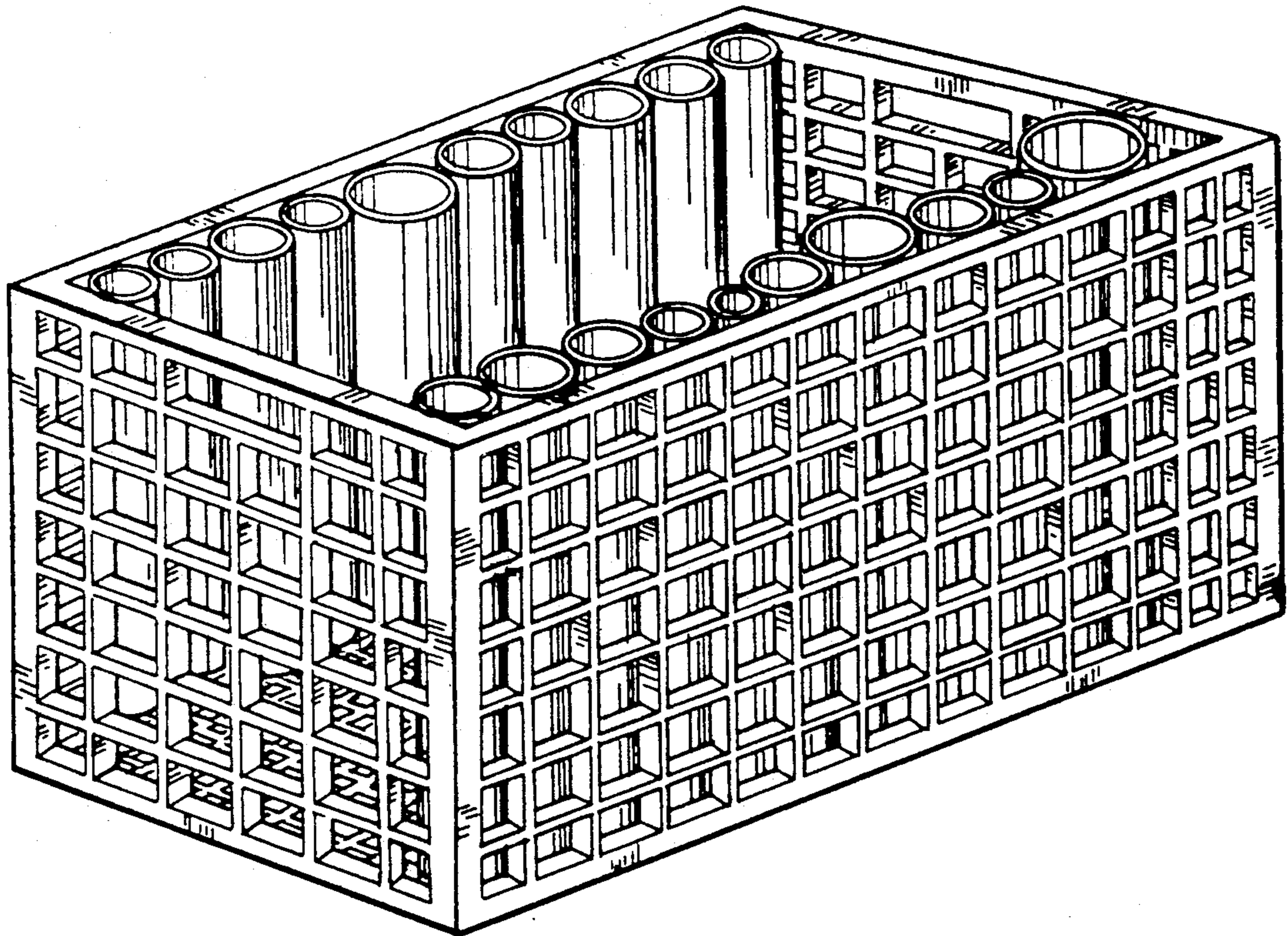

FIG. 1

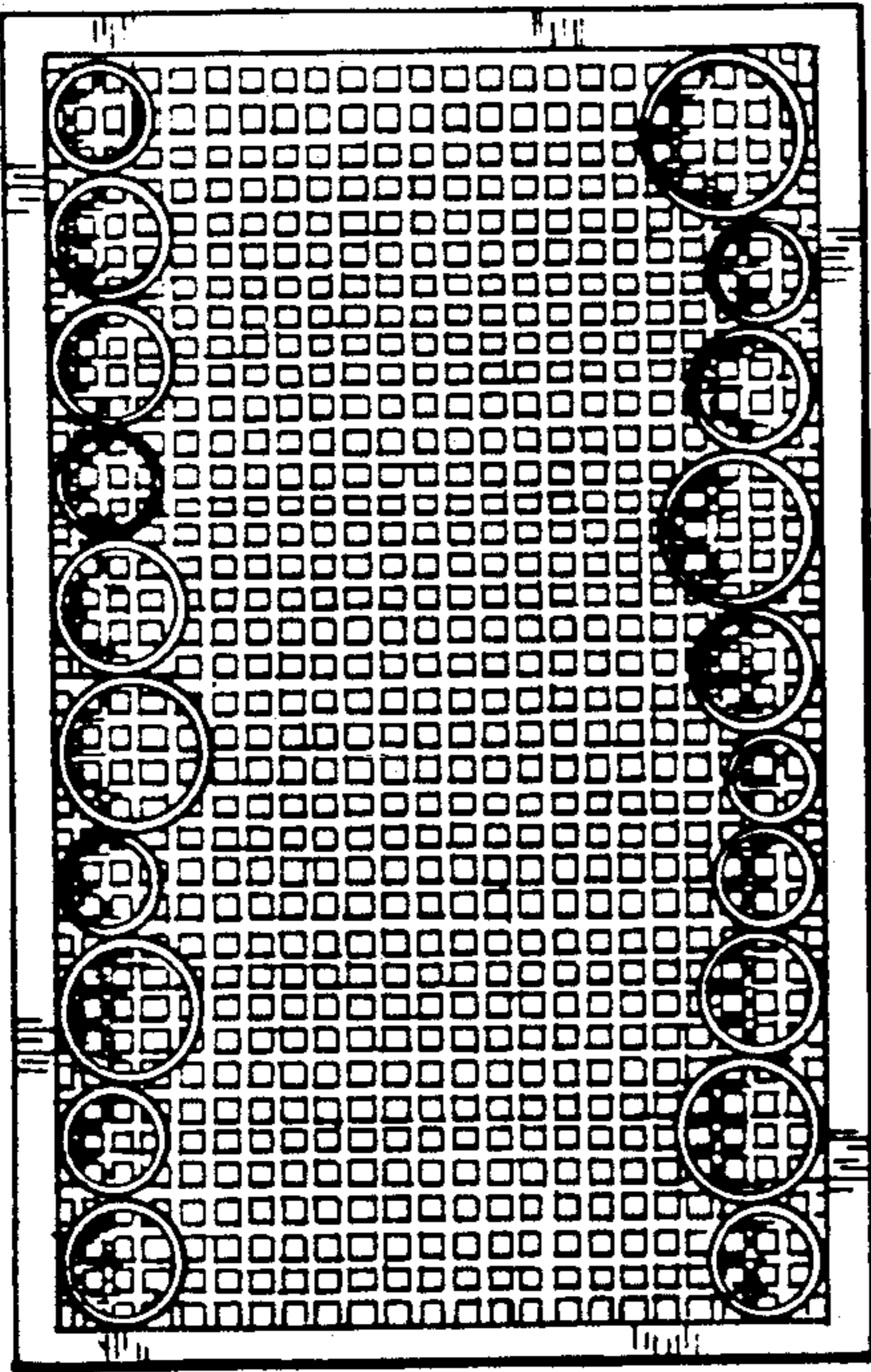
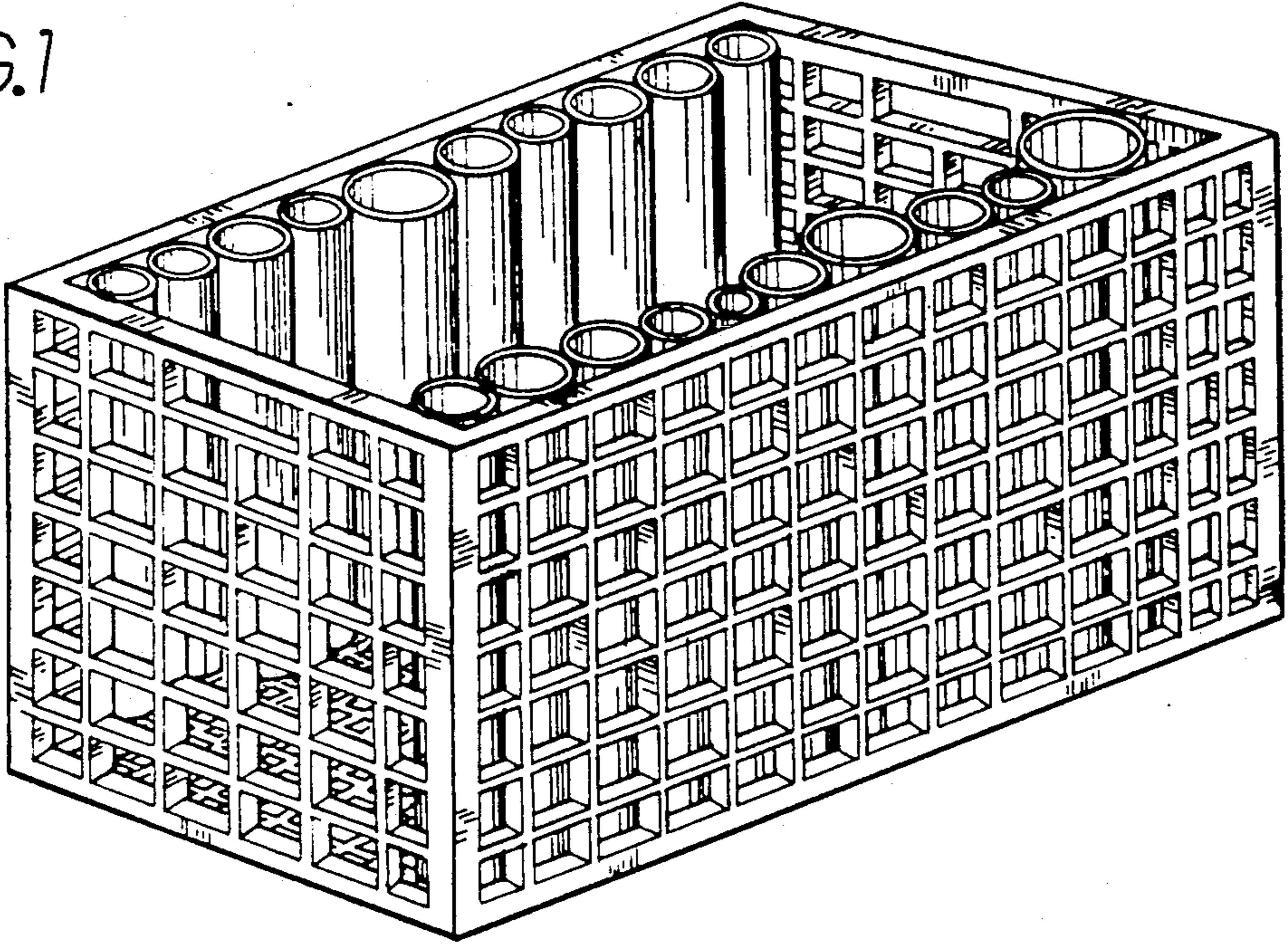

FIG. 2

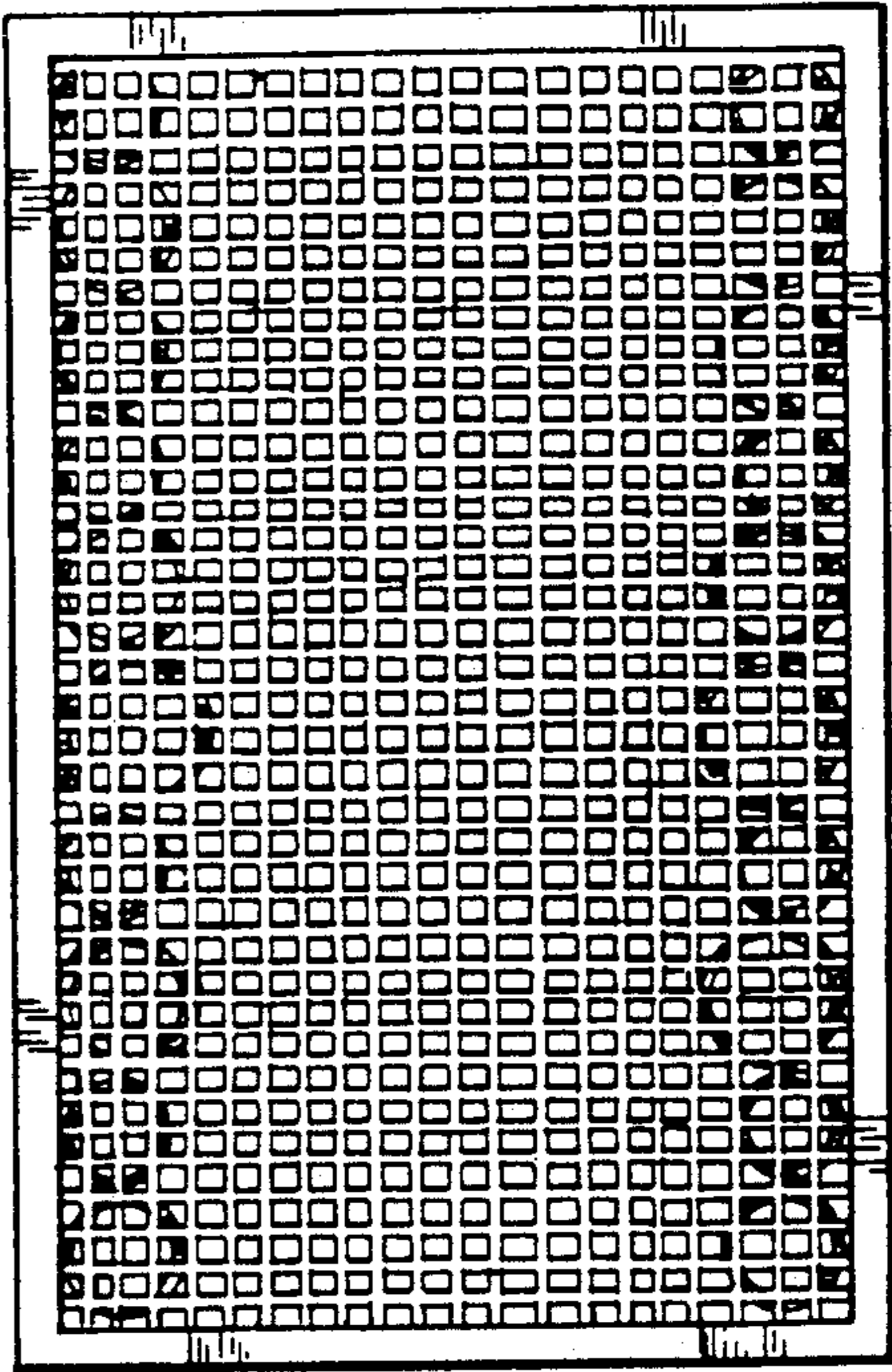

FIG. 3

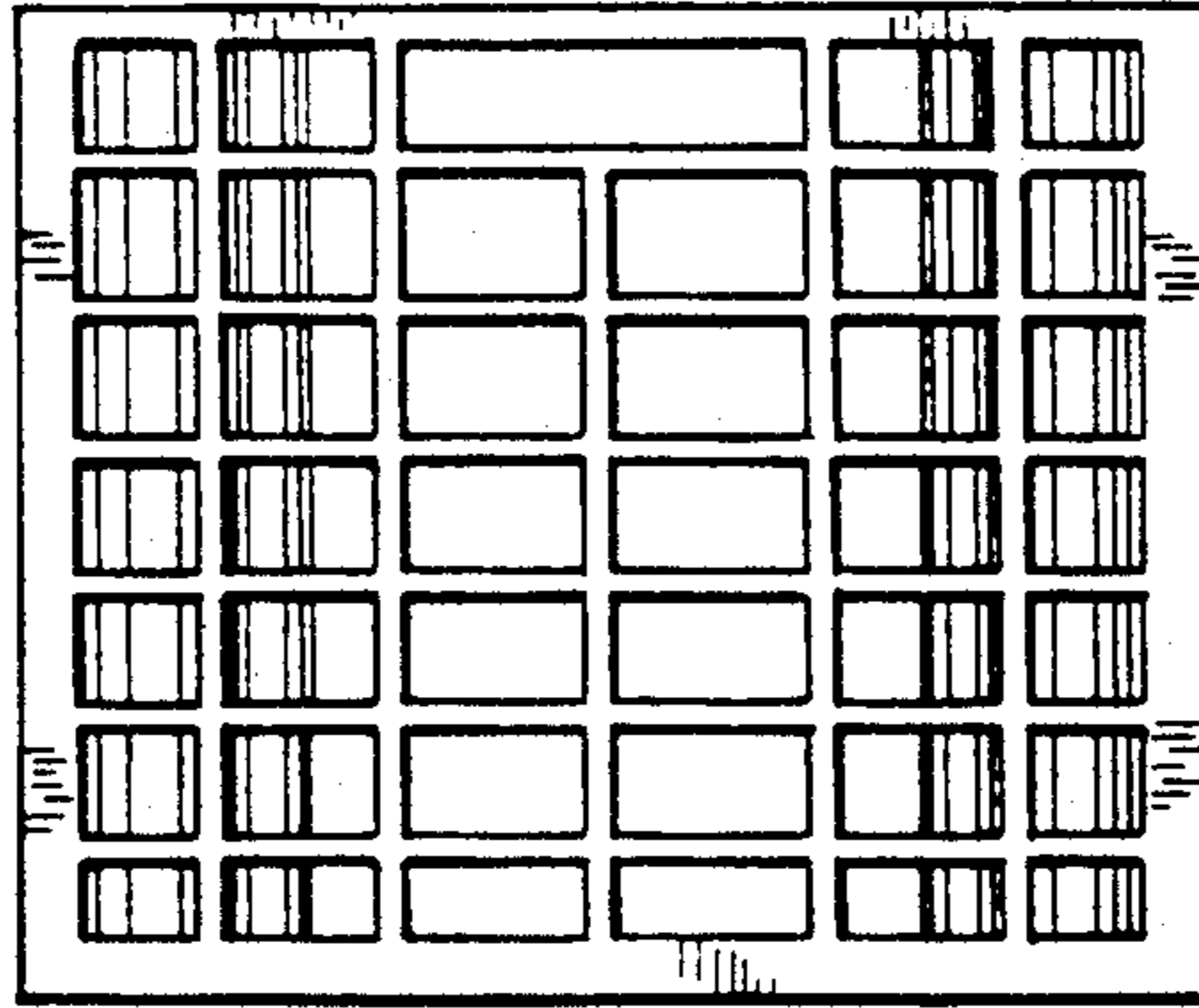

FIG. 4

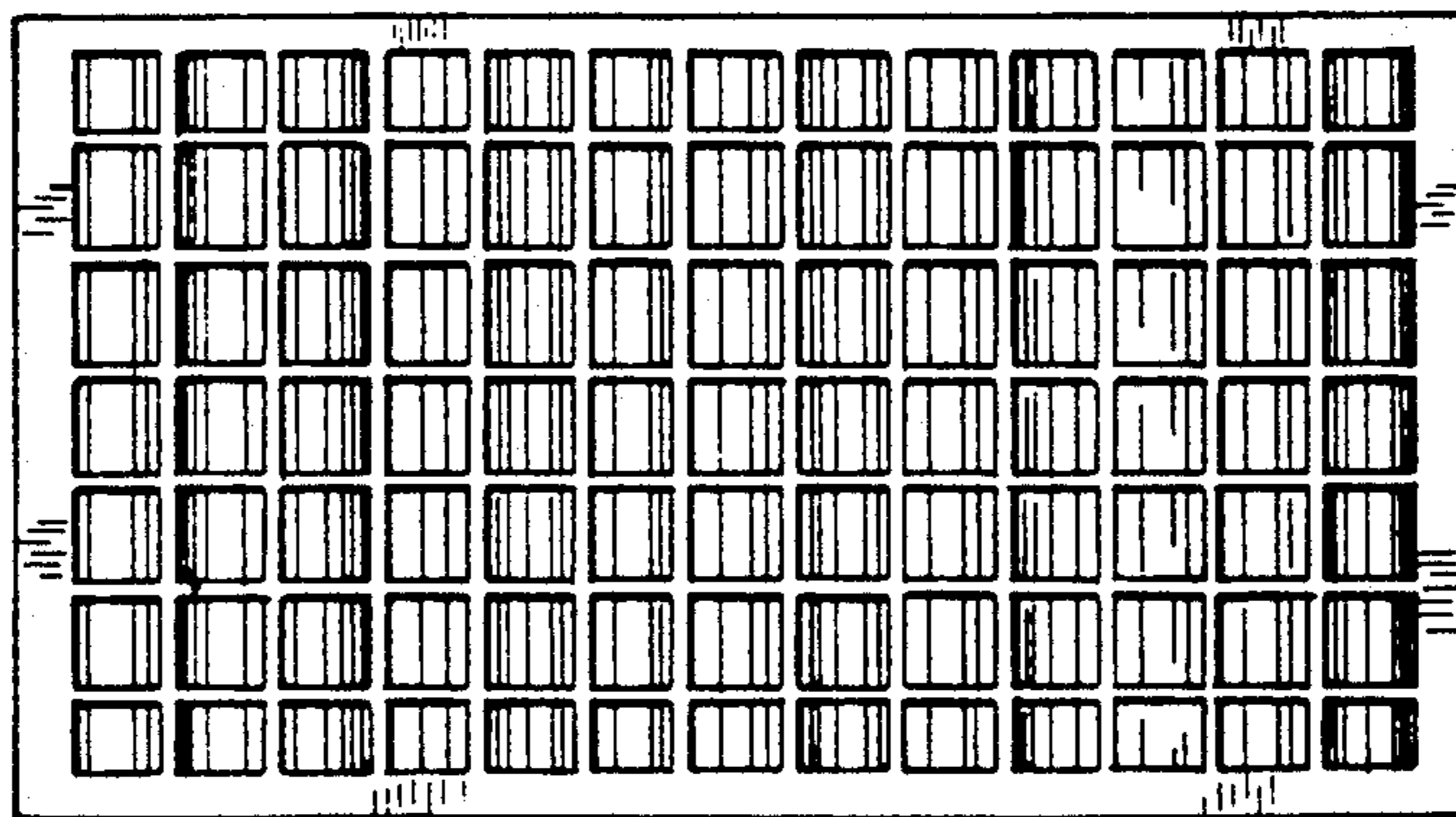

FIG. 5

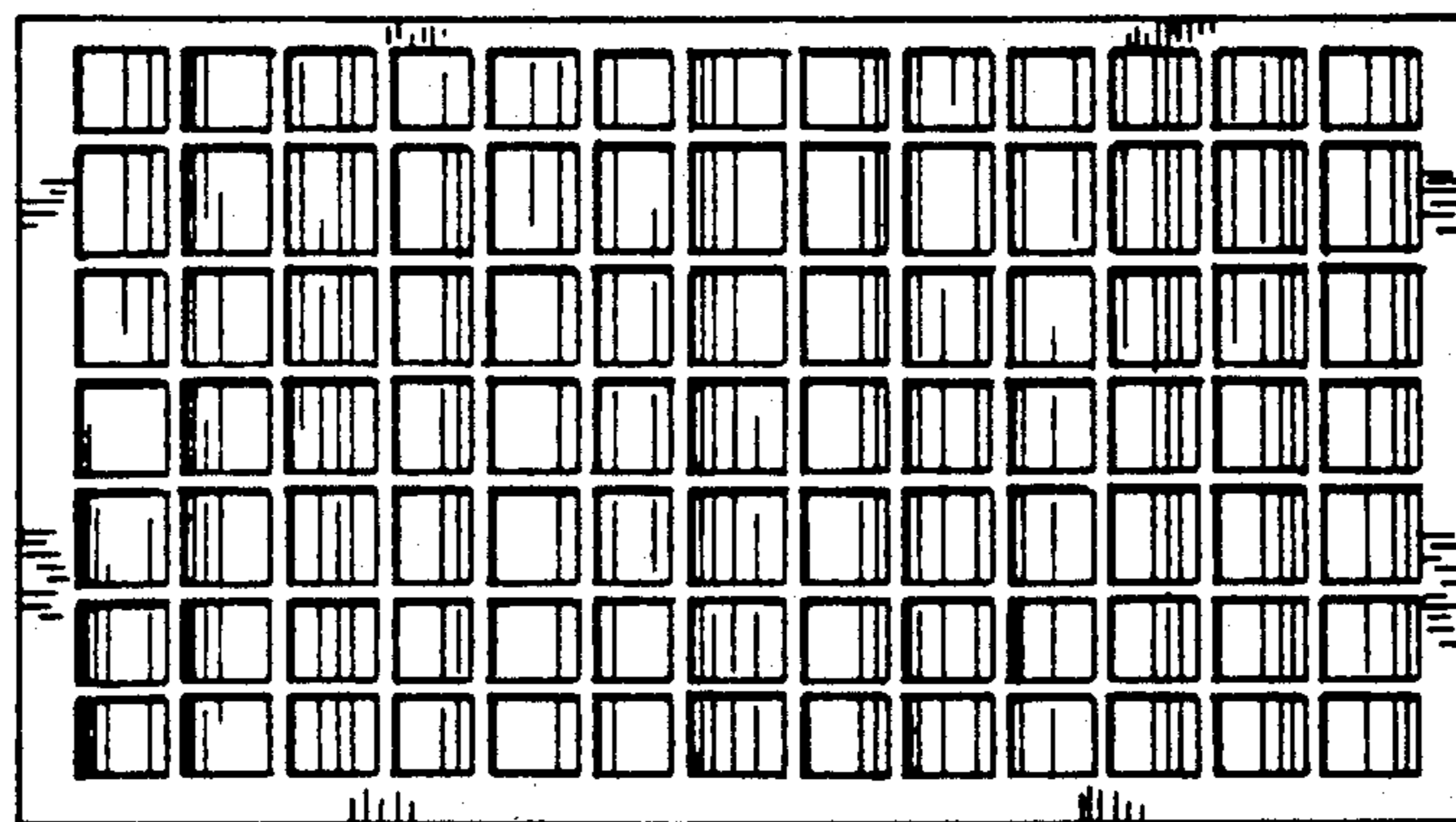

FIG. 6

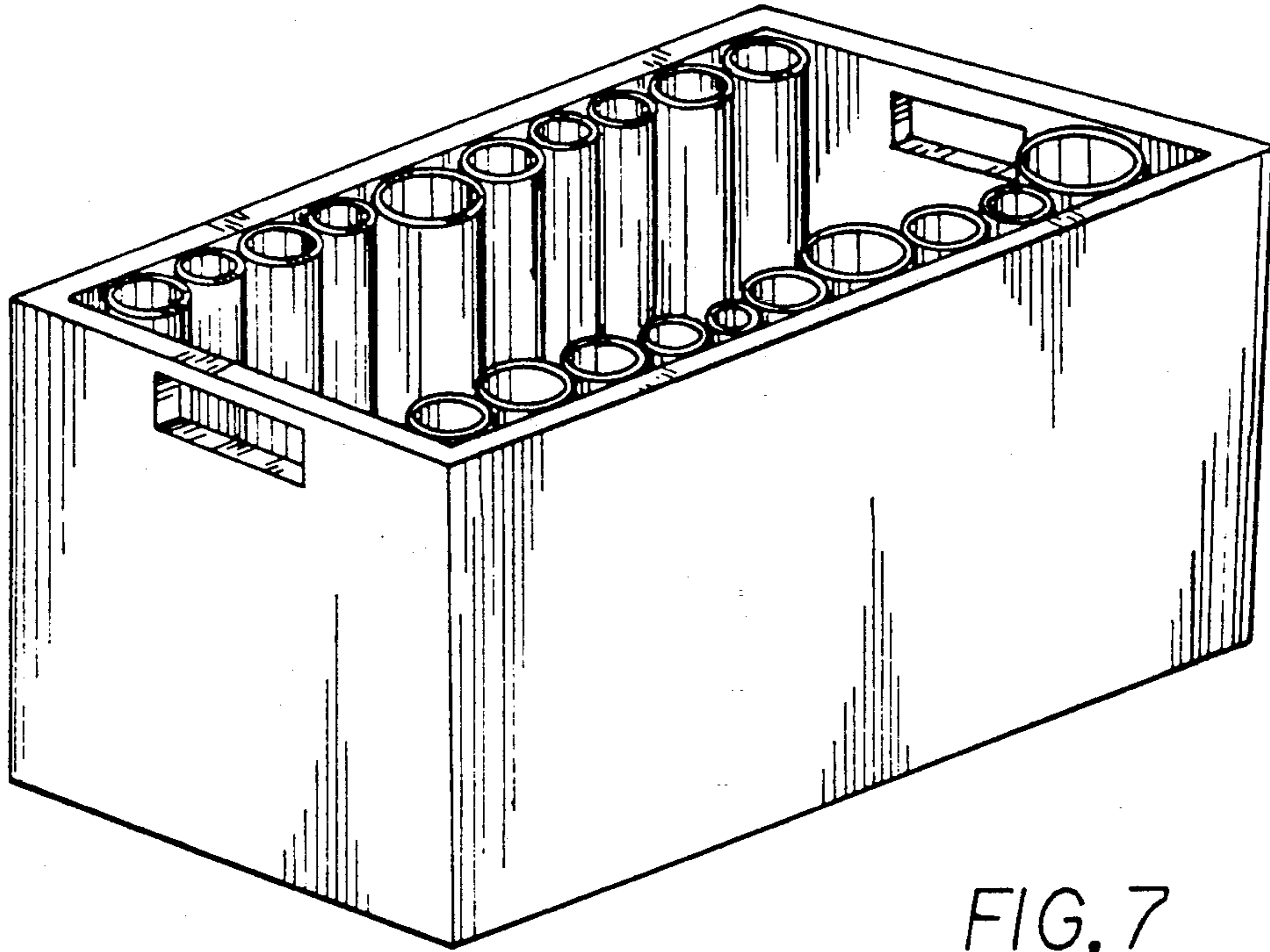

FIG. 7

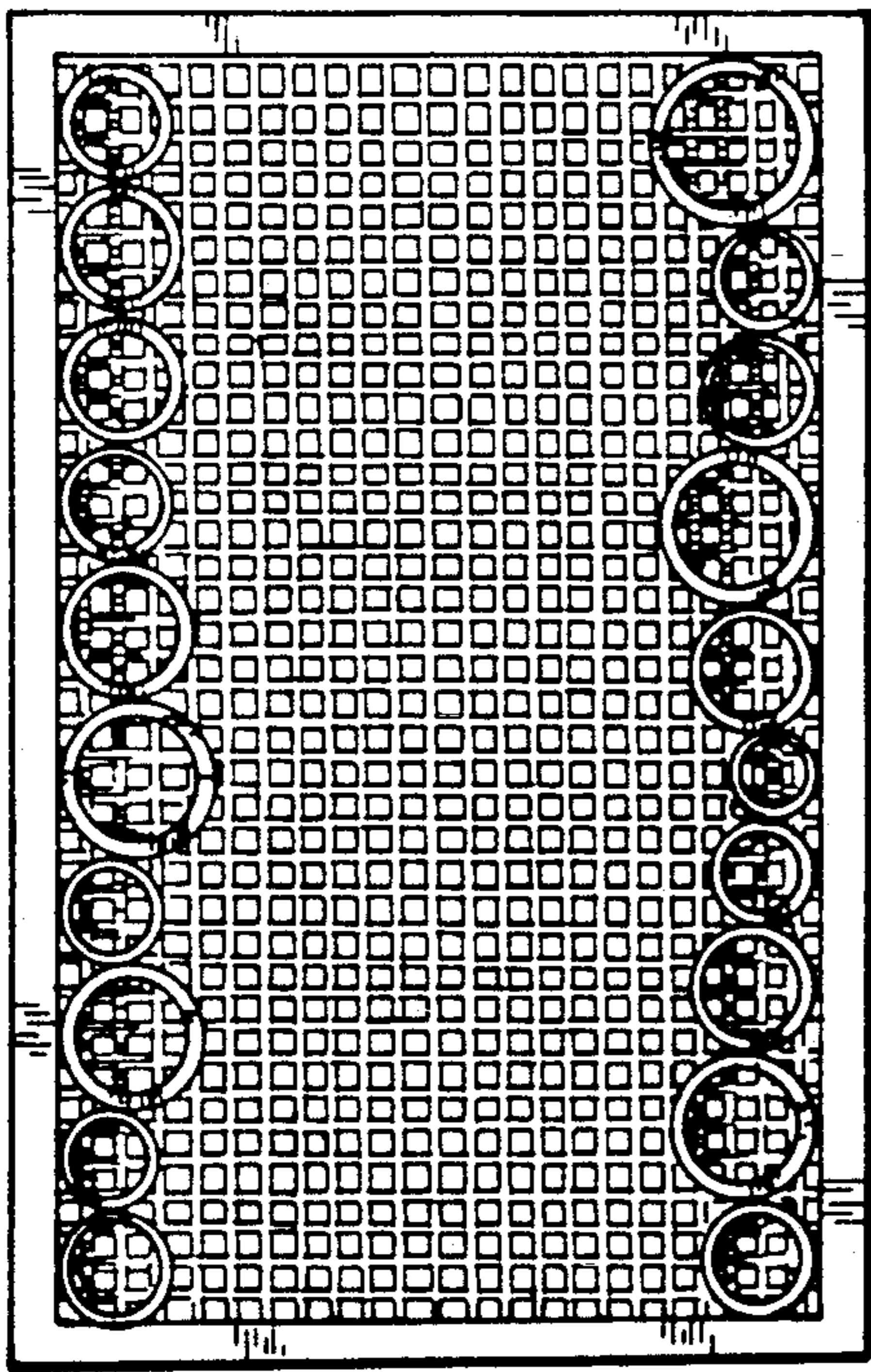

FIG. 8

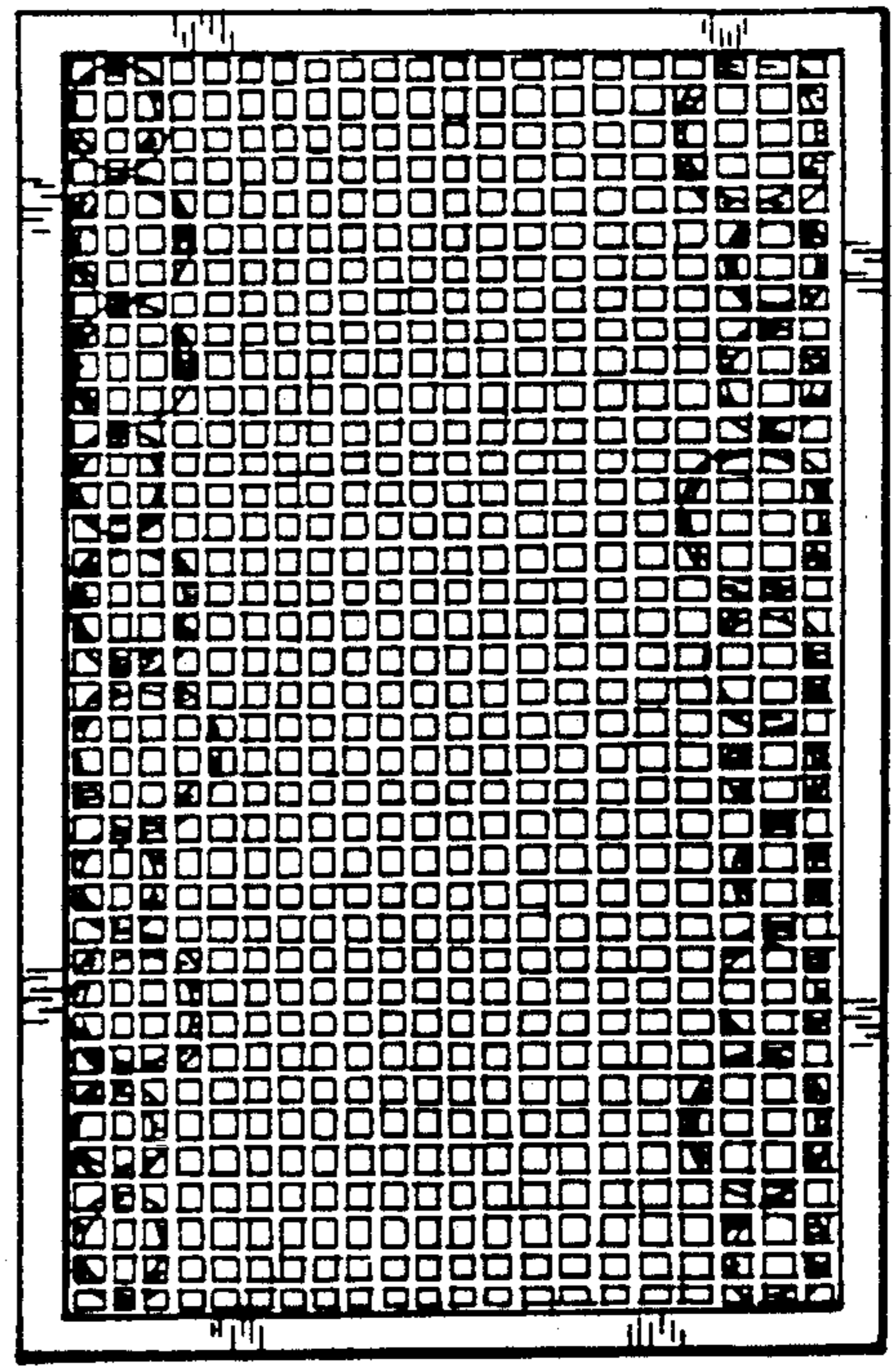

FIG. 9

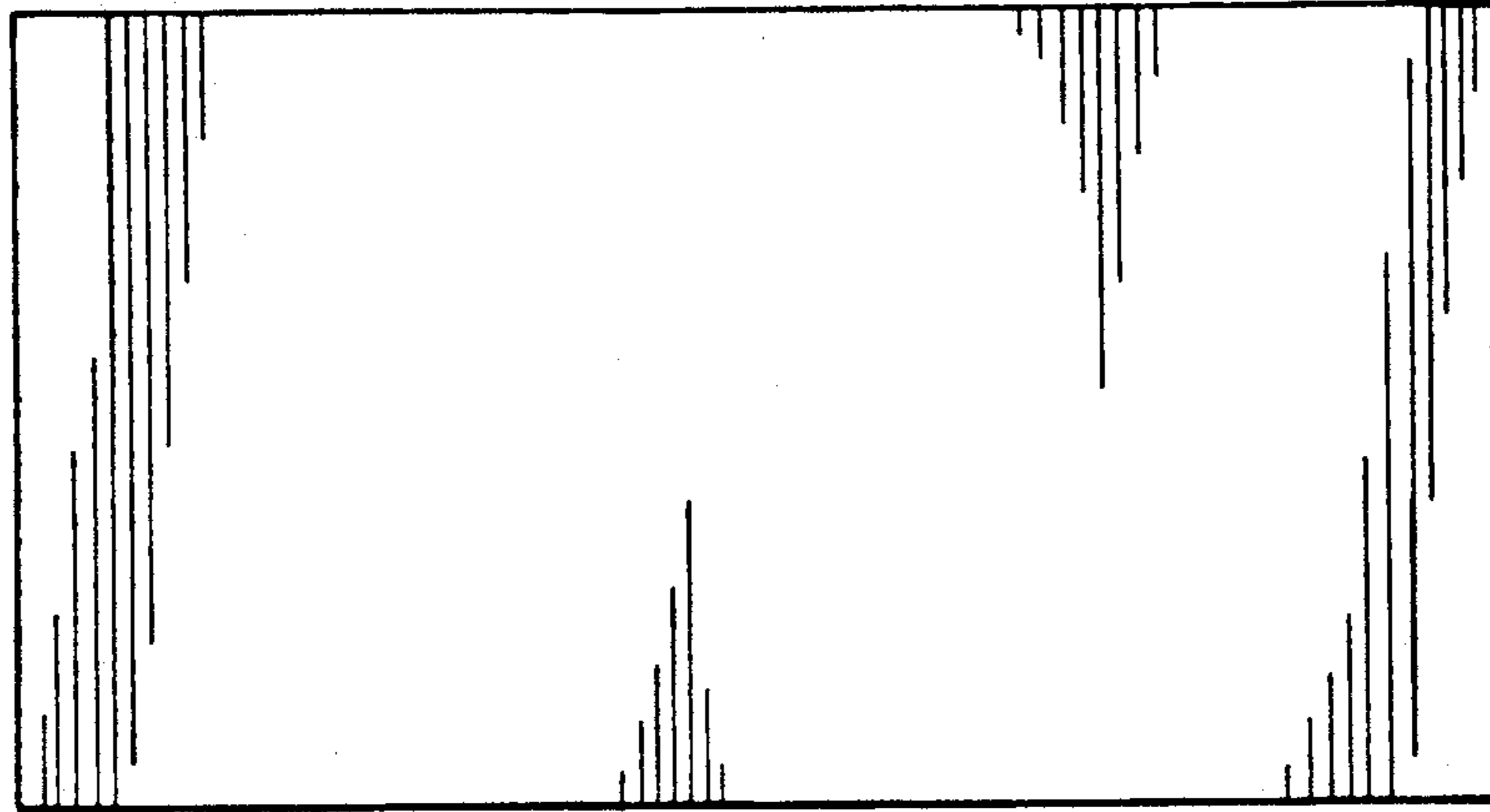

FIG. 10

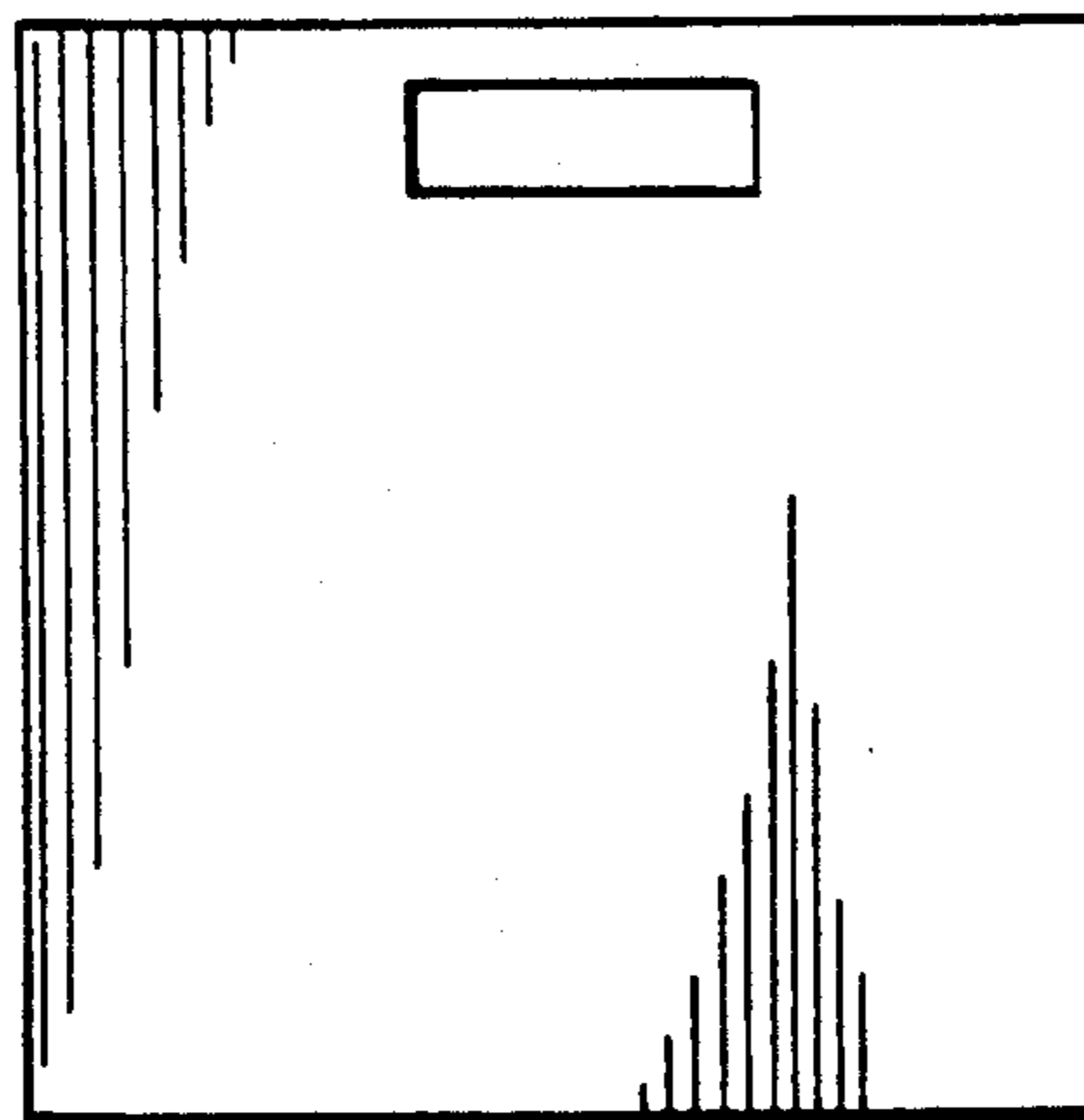

FIG. 11