



US00D326031S

United States Patent [19]

[11] Patent Number: Des. 326,031

Walters et al.

[45] Date of Patent: ** May 12, 1992

[54] ADJUSTABLE GAS TUBE

[75] Inventors: Jon S. Walters, Chesterfield, Mo.;
Neil Boatwright, Newburgh, Ind.

[73] Assignee: American General Products, Inc.,
Maryland Heights, Mo.

[**] Term: 14 Years

[21] Appl. No.: 349,502

[22] Filed: May 9, 1989

4,679,544	7/1987	Koziol	126/41 R
4,686,957	8/1987	Koziol	431/354 X
4,762,530	8/1988	Koziol	126/41 R X
4,773,384	9/1988	Koziol	126/41 R
4,827,899	5/1989	Walters et al.	126/41 R

Primary Examiner—A. Hugo Word
Assistant Examiner—Paula Allen
Attorney, Agent, or Firm—Paul M. Denk

[57] CLAIM

The ornamental design for the adjustable gas tube, as shown and described.

DESCRIPTION

FIG. 1 is a front perspective view of an adjustable gas tube showing my new design;
FIG. 2 is a top plan view thereof;
FIG. 3 is a bottom plan view thereof;
FIG. 4 is a side elevational view thereof;
FIG. 5 is a front elevational view thereof;
FIG. 6 is a side elevational view of another embodiment thereof;
FIG. 7 is a front elevational view thereof;
FIG. 8 is a side elevational view of another embodiment thereof; and,
FIG. 9 is a front elevational view thereof.

Related U.S. Application Data

[63] Continuation-in-part of Ser. No. 127,425, Dec. 2, 1987, Pat. No. 482,799.

[52] U.S. Cl. D7/402

[58] Field of Search D7/402, 407, 332-337;
D23/266, 418; 126/41 R, 39 E; 431/354;
D8/385, 384, 387, 391, 393

[56] References Cited

U.S. PATENT DOCUMENTS

D. 231,328 4/1974 Nasser D8/385 X
4,598,692 7/1986 Hitch 126/41 R

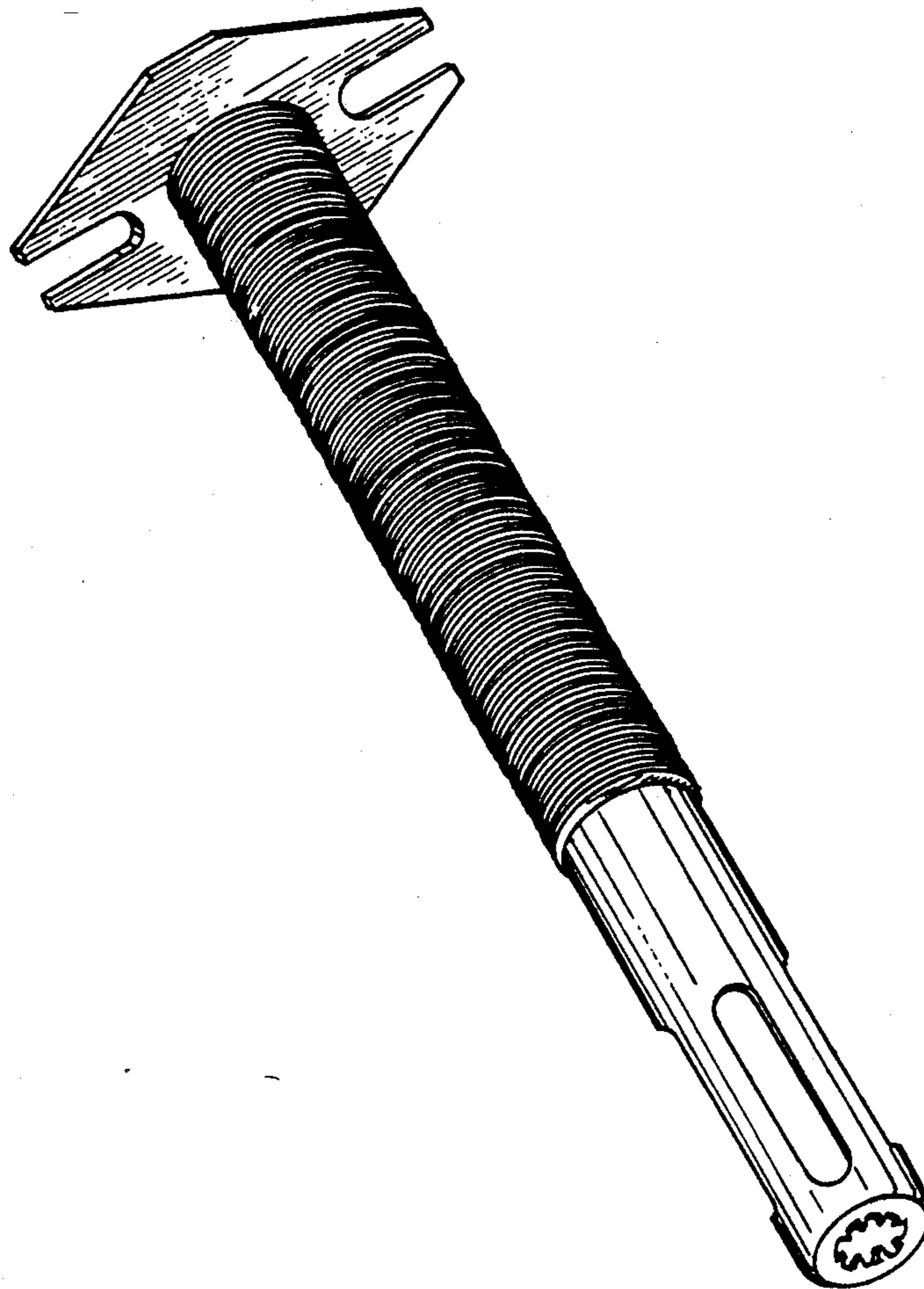

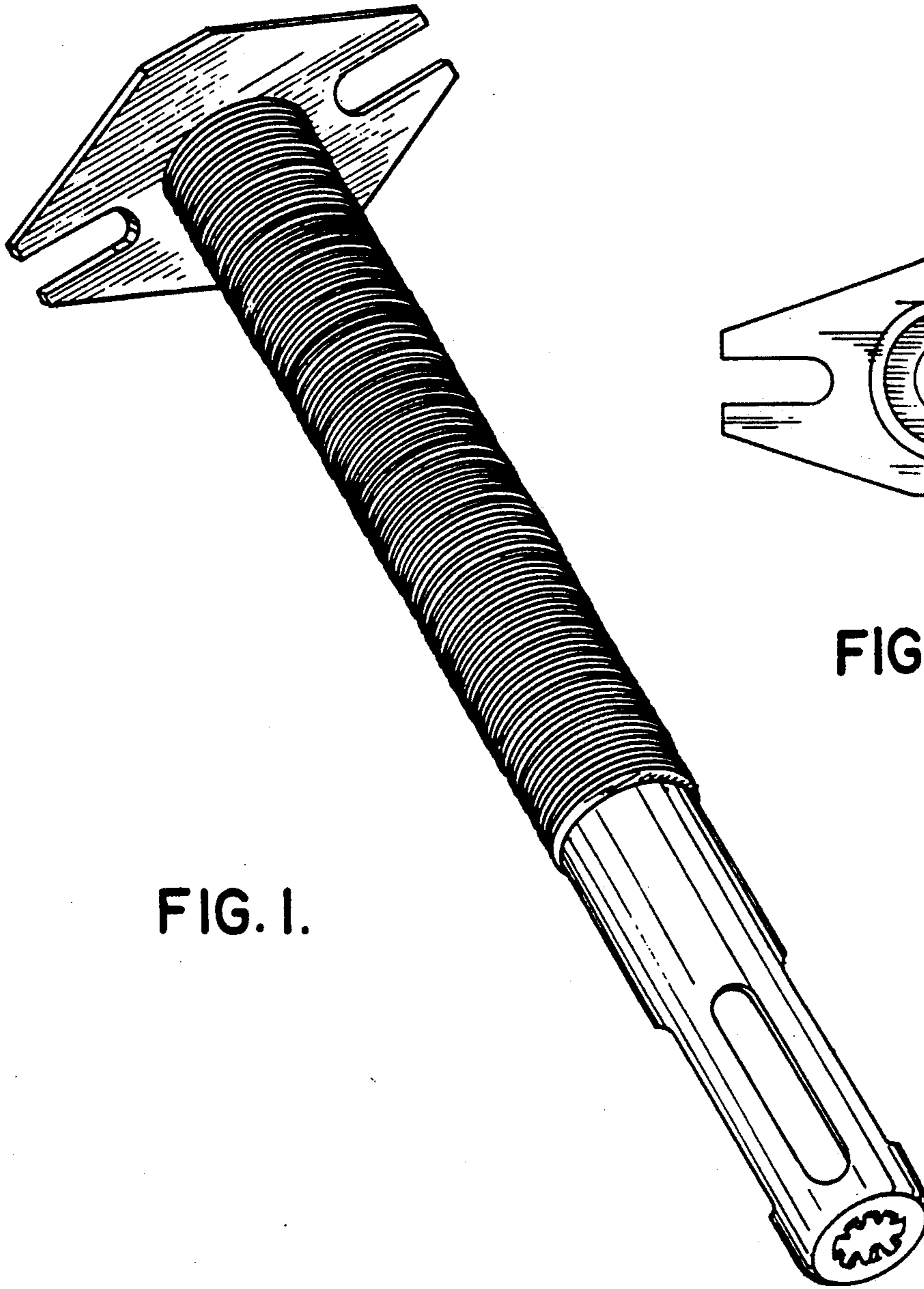

FIG. 1.

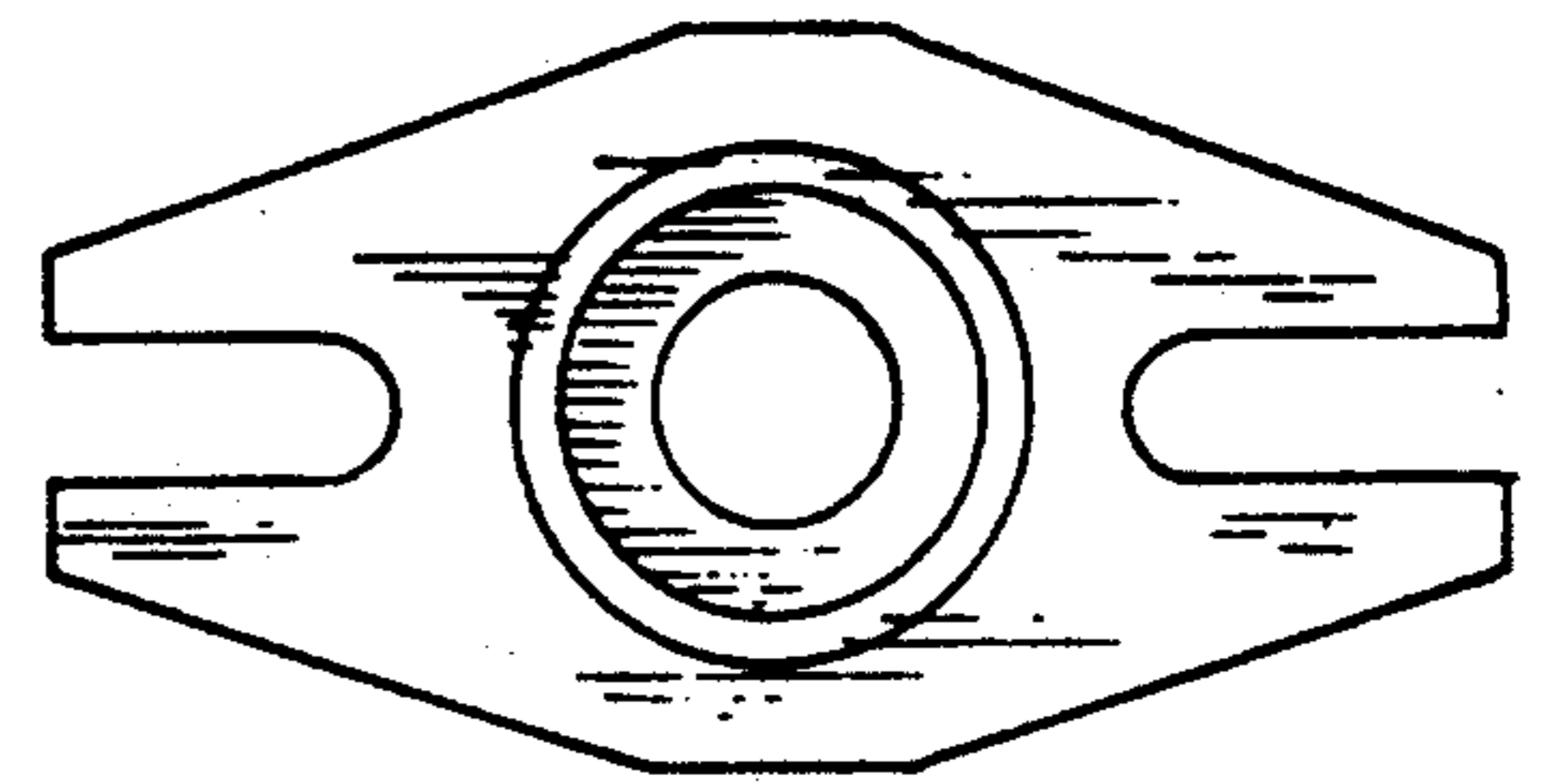

FIG. 2.

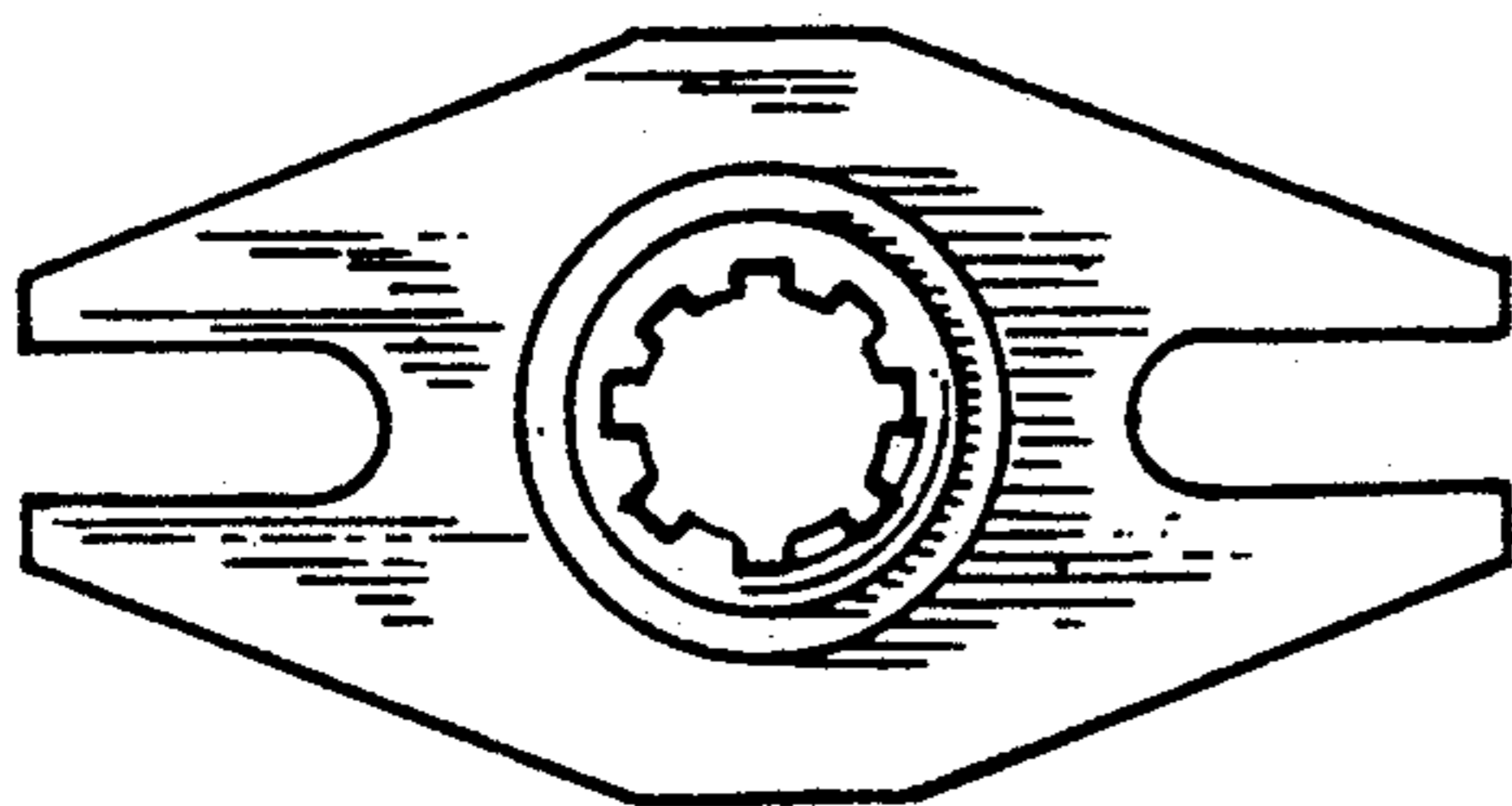

FIG. 3.

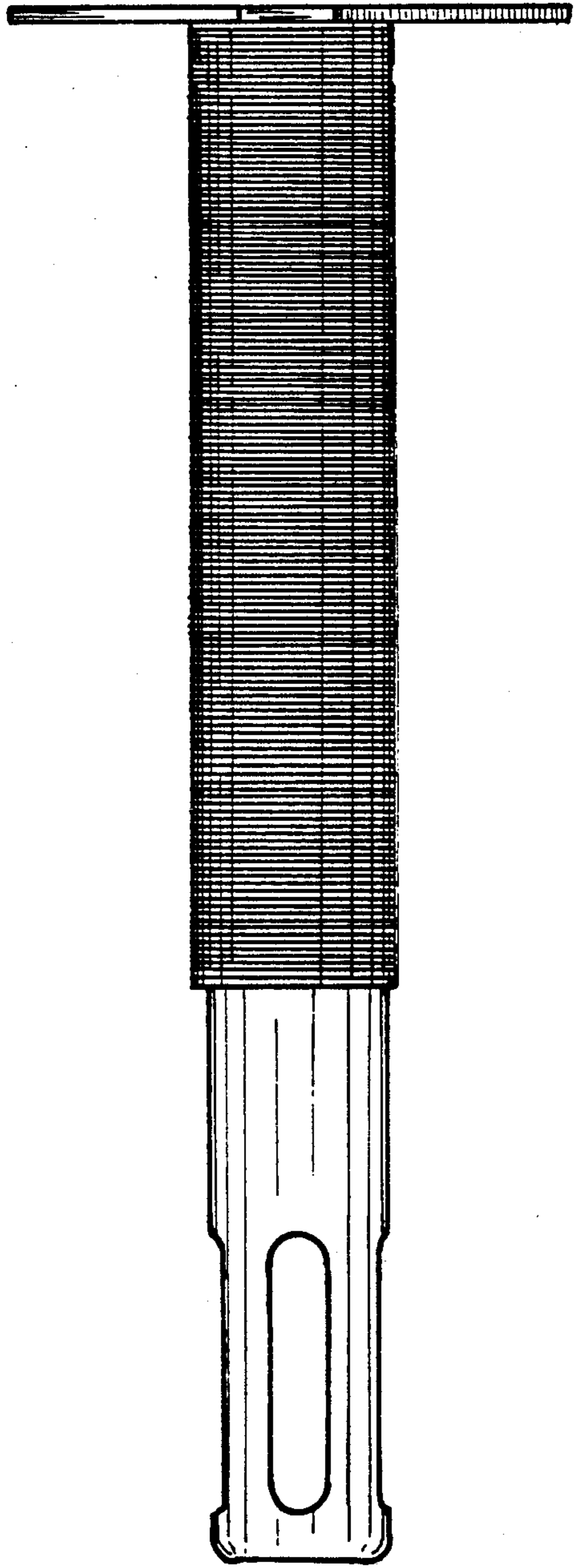

FIG. 4.

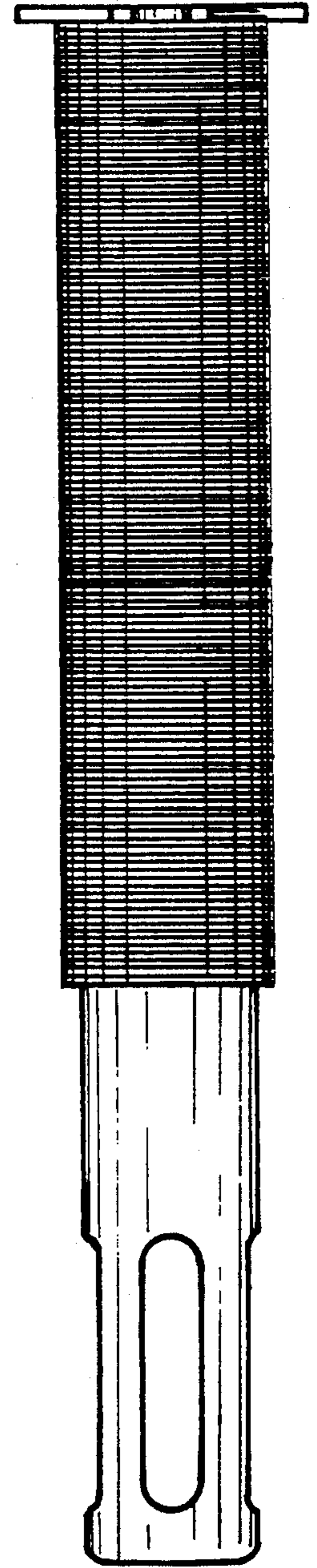

FIG. 5.

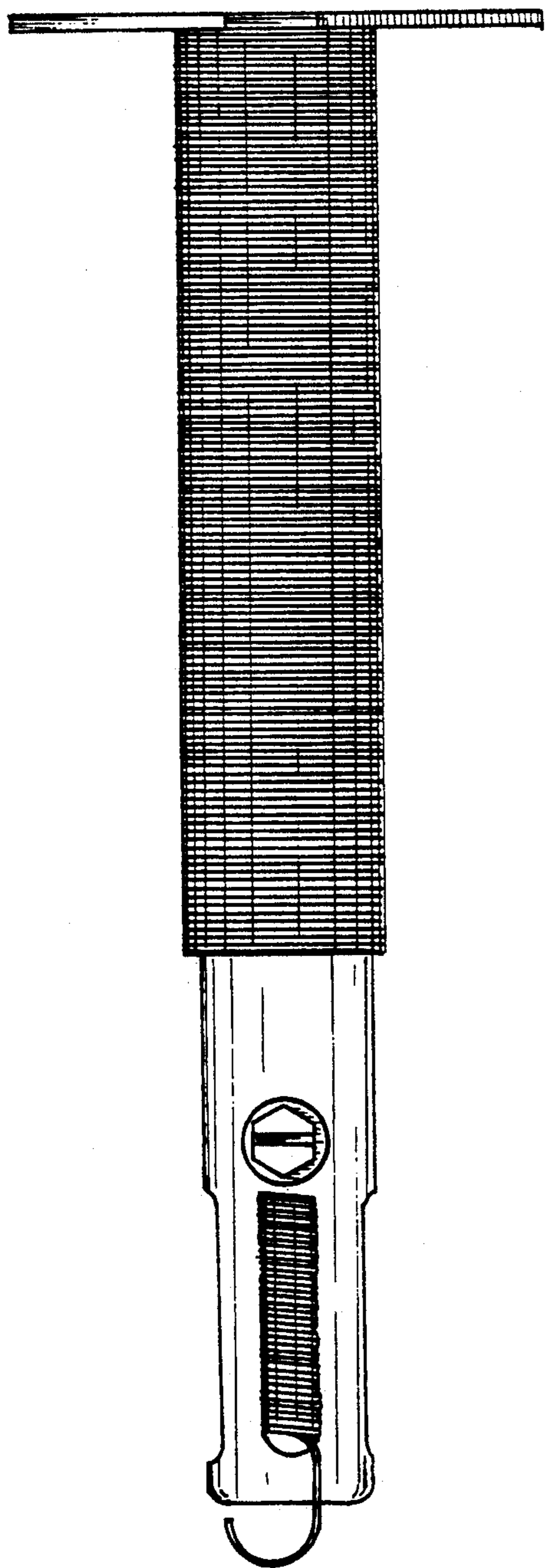

FIG. 6.

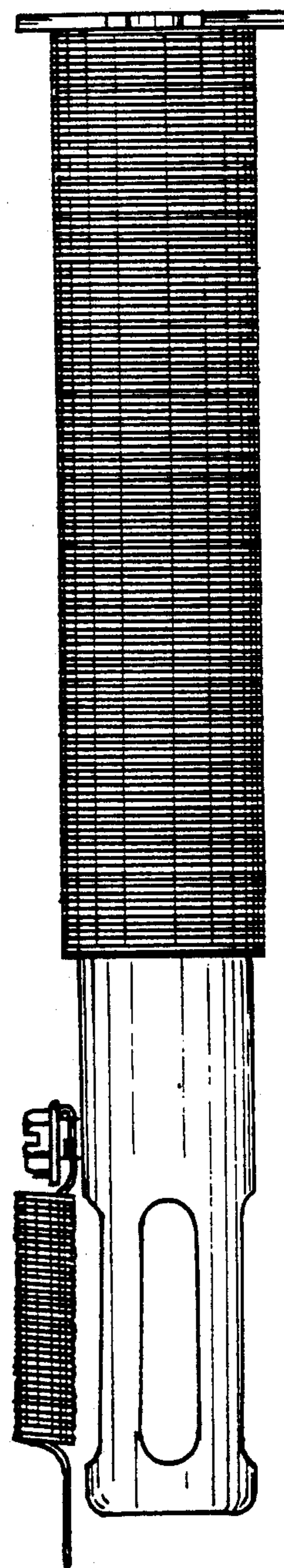

FIG. 7.

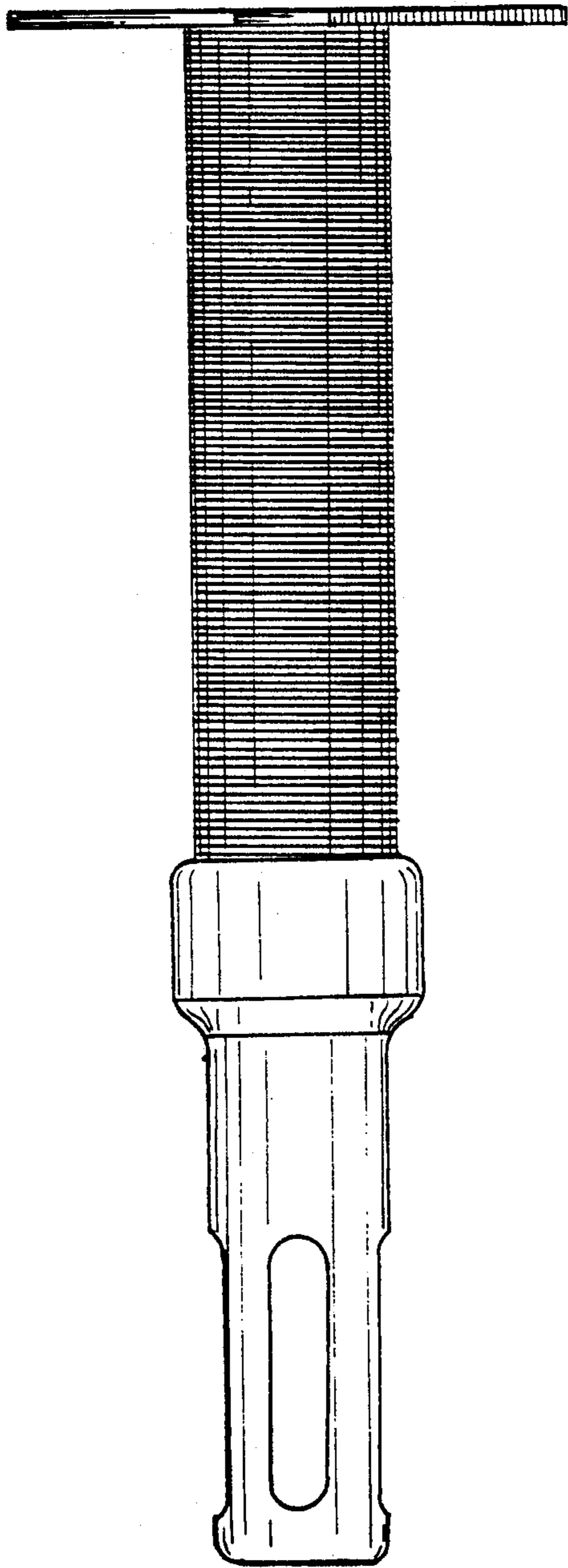

FIG. 8.

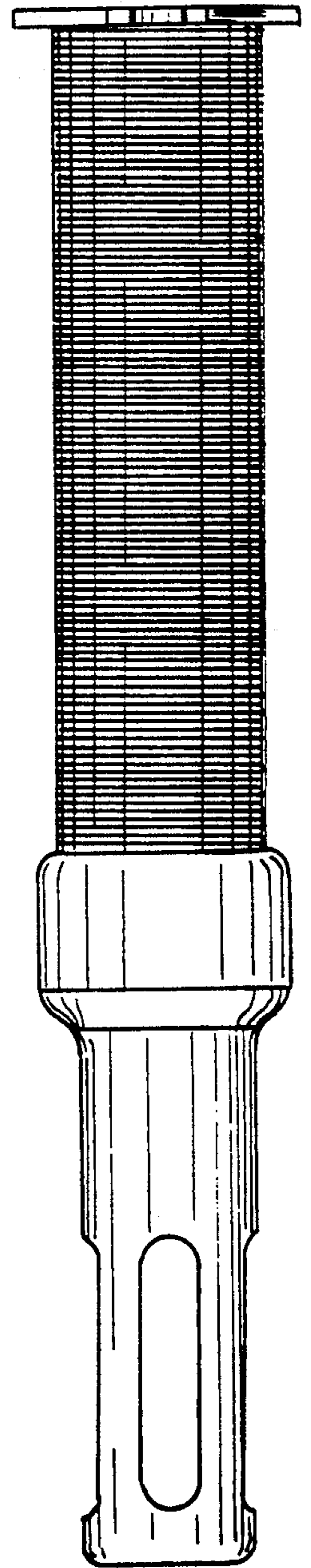

FIG. 9.