



US00D325963S

United States Patent [19]

[11] Patent Number: **Des. 325,963**

Anderson

[45] Date of Patent: **** May 5, 1992**

[54] OUTDOOR HEATER

[75] Inventor: **David L. Anderson, St. Charles, Ill.**

[73] Assignee: **Odin Industries, Inc., Elburn, Ill.**

[**] Term: **14 Years**

[21] Appl. No.: **580,302**

[22] Filed: **Jan. 22, 1991**

[52] U.S. Cl. **D23/342; D26/68**

[58] Field of Search **D23/332, 335, 337, 342, D23/343, 344, 346; 392/422, 423, 440, 435; D26/67, 68; 362/431**

[56] References Cited

U.S. PATENT DOCUMENTS

D. 202,440	9/1965	Pettengill	D26/67
D. 219,024	10/1970	Onodera et al.	D23/342
D. 319,703	9/1991	Hazerjian et al.	D26/67
2,634,361	4/1953	Reynolds	392/435
2,985,261	5/1961	Kubesh	362/431
4,678,139	8/1988	Poppenheimer	362/431

FOREIGN PATENT DOCUMENTS

357801 12/1961 Switzerland 362/431

Primary Examiner—Wallace R. Burke
Assistant Examiner—Lisa Lichtenstein
Attorney, Agent, or Firm—Basil E. Demeur; Robert E. Knechtel

[57] CLAIM

The ornamental design for an outdoor heater, as shown and described.

DESCRIPTION

FIG. 1 is a front and right side perspective view of an outdoor heater showing my new design; FIG. 2 is a front elevation view thereof; FIG. 3 is a left side elevation view thereof, the opposite side being a mirror image of that shown; FIG. 4 is a rear elevation view thereof; FIG. 5 is a top plan view thereof; FIG. 6 is a bottom plan view thereof; and, FIG. 7 is a front elevation view of an outdoor heater showing a second embodiment of my new design, the sole difference being the configuration of the base.

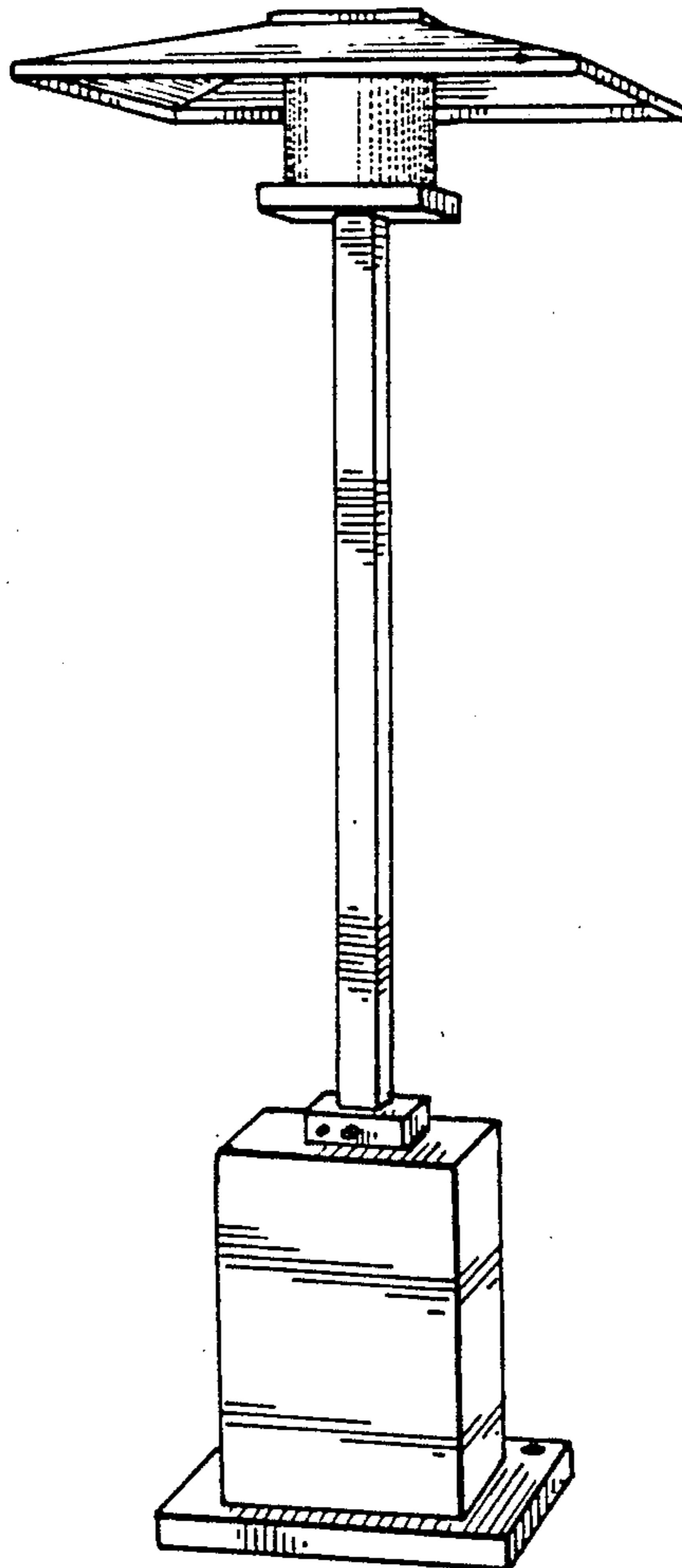

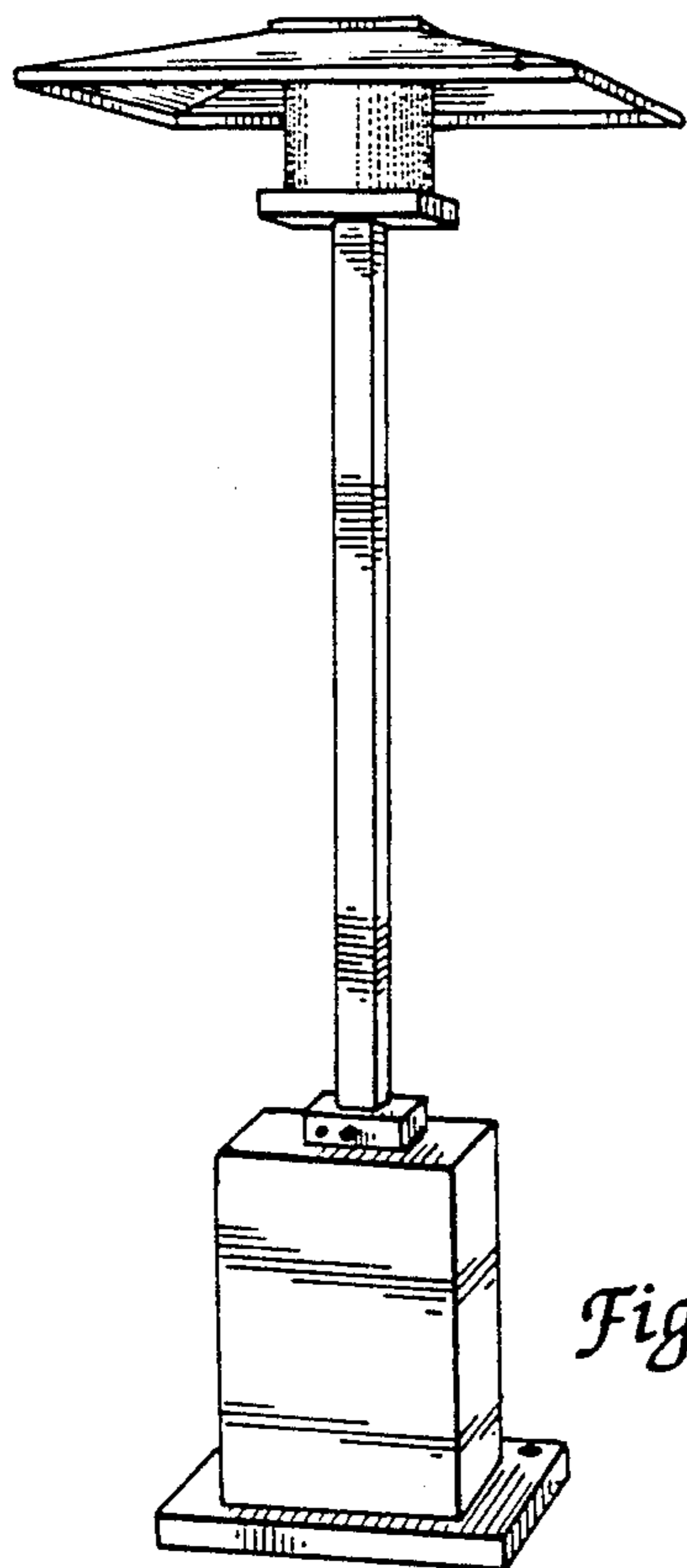

Fig. 1

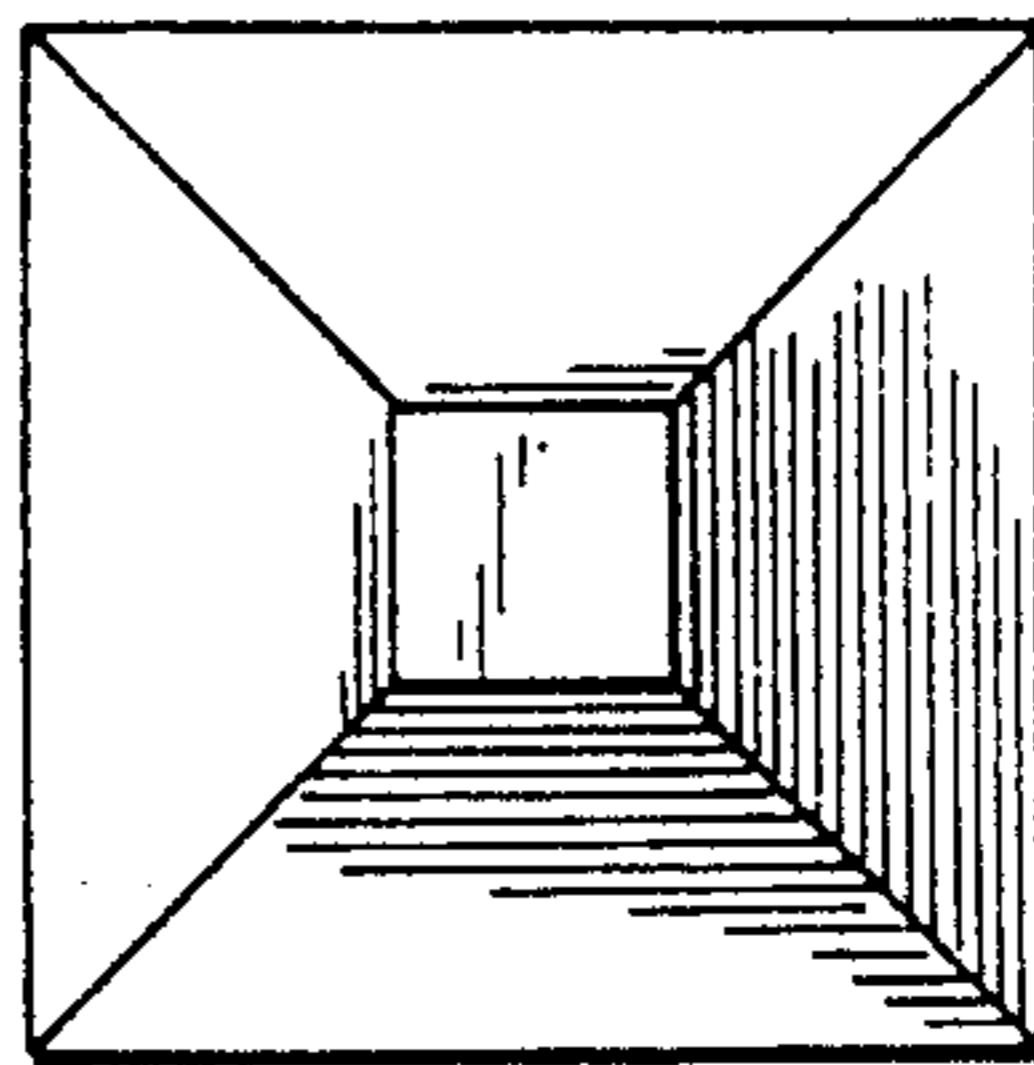

Fig. 5

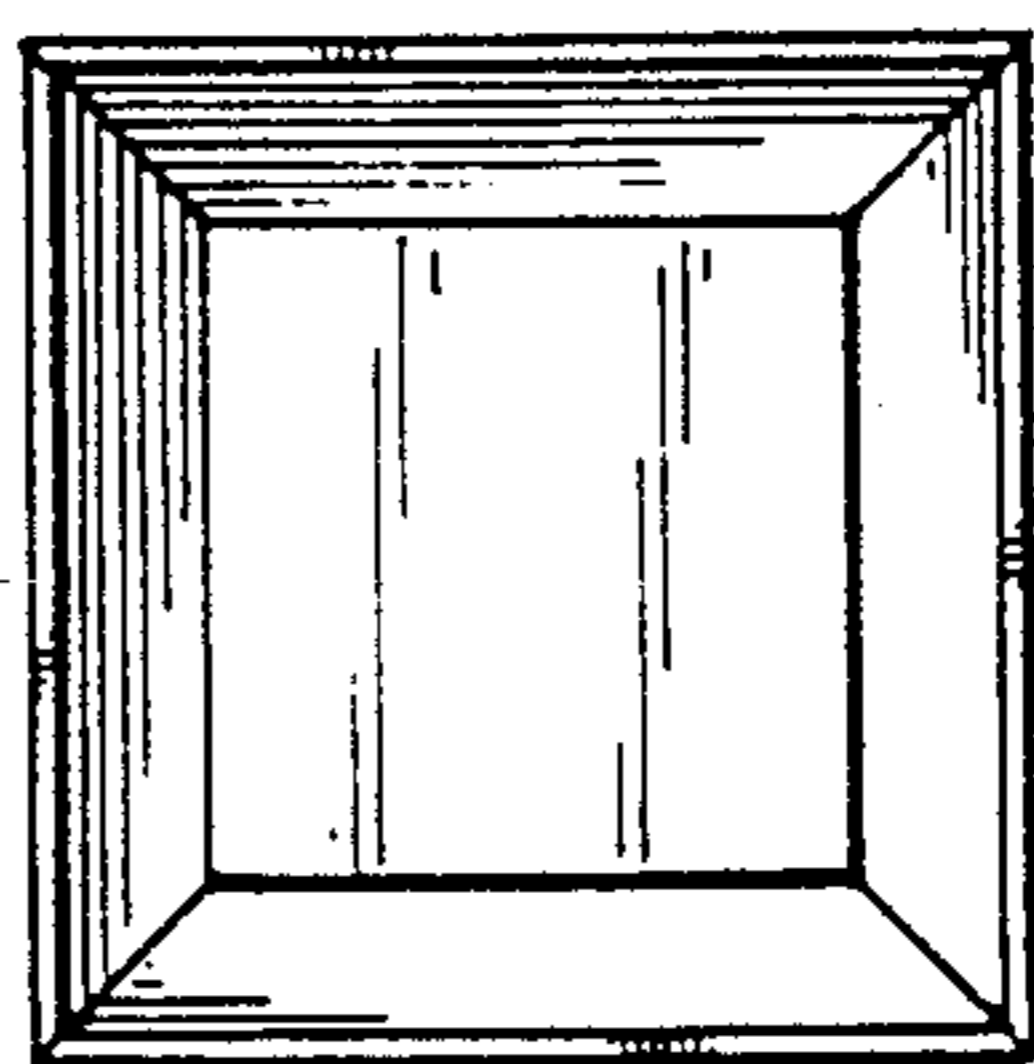

Fig. 6

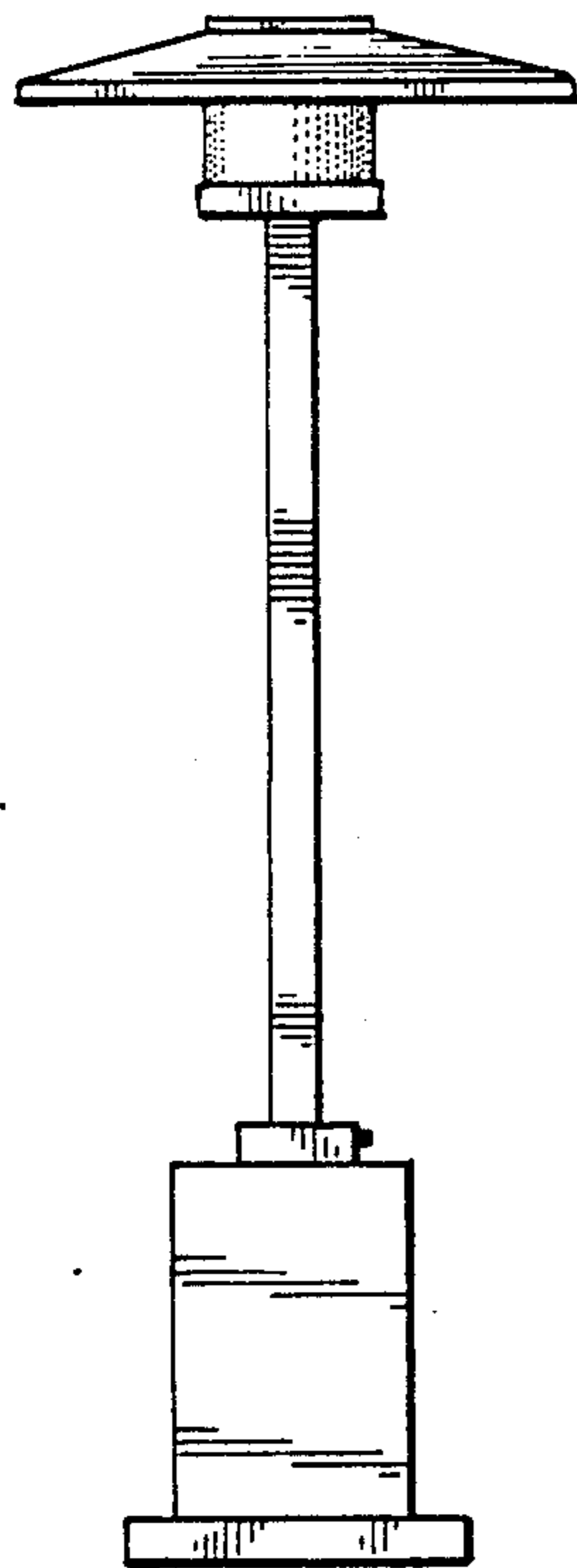

Fig. 3

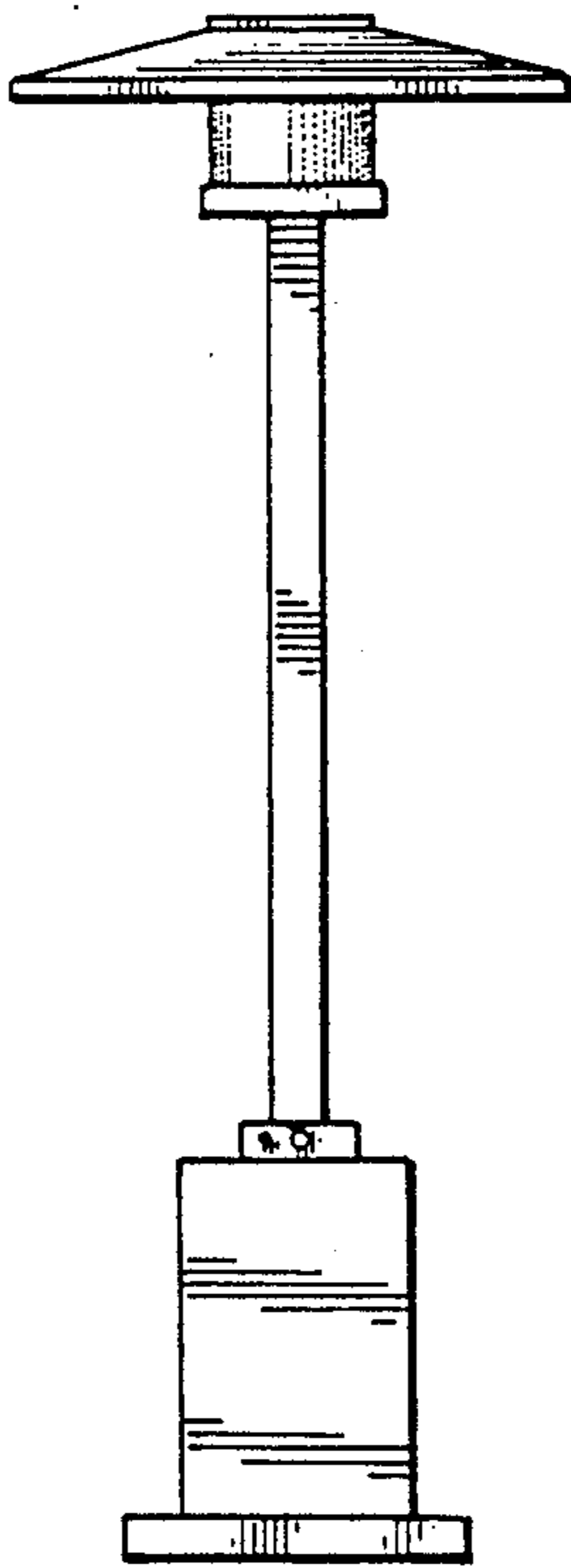

Fig. 2

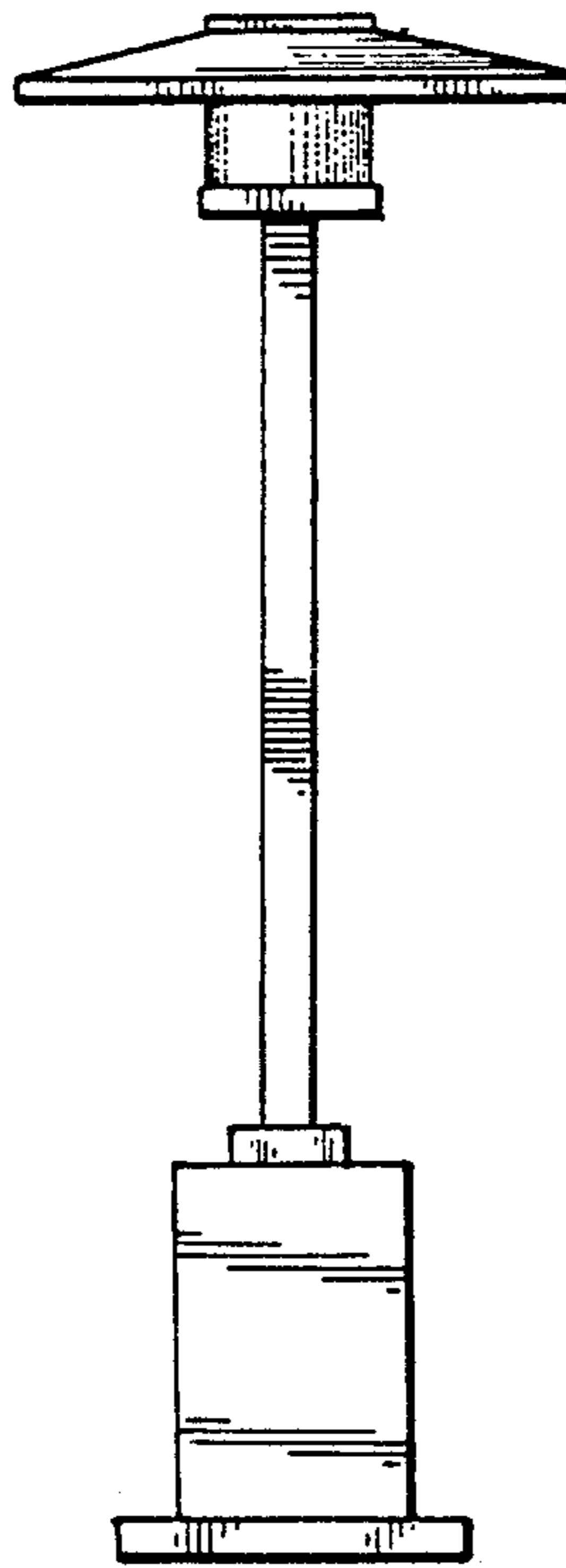

Fig. 4

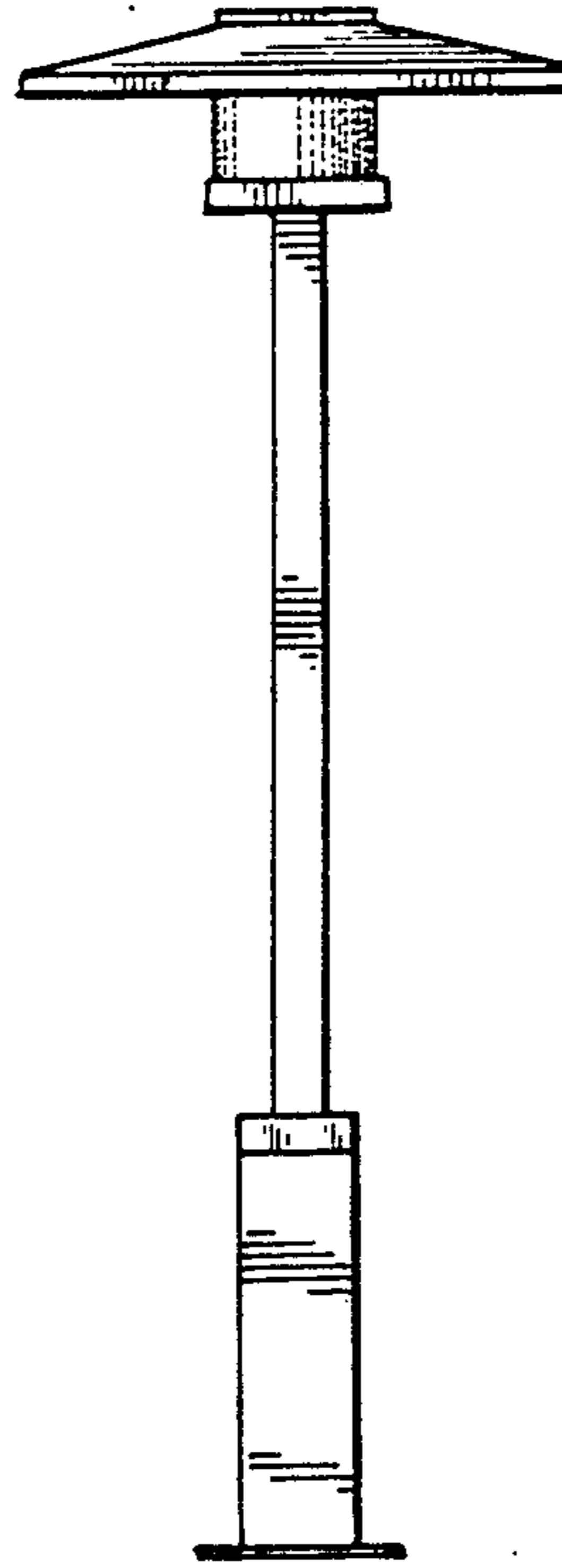

Fig. 7