



US00D325864S

United States Patent [19] Diego

[11] Patent Number: Des. 325,864

[45] Date of Patent: ** May 5, 1992

[54] WRENCH

[76] Inventor: Edward A. Diego, 4825 NW., 93rd Ter., Sunrise, Fla. 33351

[**] Term: 14 Years

[21] Appl. No.: 297,543

[22] Filed: Jan. 17, 1989

[52] U.S. Cl. D8/28

[58] Field of Search D8/21, 22, 23, 24, 25, D8/26, 27, 28, 29; 81/177, 177.2, 177.7, 177.8, 177.9

[56] References Cited

U.S. PATENT DOCUMENTS

1,168,204	1/1916	Helstrom .	
1,281,228	10/1918	Sutton .	
2,426,763	9/1947	Curtis	81/125.1
2,438,633	3/1948	Condor .	
2,886,998	5/1959	Scott	81/177.7
2,963,930	12/1960	Clothier	81/177
3,186,265	6/1965	Wenturine	81/177.9
3,376,768	4/1968	Fortunato	81/177.2
4,084,456	4/1978	Pasbrig	81/125.1
4,530,262	7/1985	Pownall	81/177.9

OTHER PUBLICATIONS

Proto Tools, 1969, p. 47, Holding Clamps.

Primary Examiner—Bernard Ansher

Assistant Examiner—Philip Hyder

Attorney, Agent, or Firm—Terry M. Gernstein

[57] CLAIM

The ornamental design for a wrench, as shown and described.

DESCRIPTION

FIG. 1 is a partially exploded perspective view of a wrench showing my new design;
 FIG. 2 is a top plan view thereof;
 FIG. 3 is a top plan view thereof, in an extended position;
 FIG. 4 is a front elevational view thereof;
 FIG. 5 is a bottom plan view thereof;
 FIG. 6 is a rear elevational view thereof;
 FIG. 7 is a right side elevational view thereof;
 FIG. 8 is a left side elevational view thereof;
 FIG. 9 is a perspective view of a second embodiment thereof;
 FIG. 10 is a top plan view of FIG. 9;
 FIG. 11 is a front elevational view of FIG. 9;
 FIG. 12 is a bottom plan view of FIG. 9;
 FIG. 13 is a rear elevational view of FIG. 9;
 FIG. 14 is a right side elevational view of FIG. 9; and,
 FIG. 15 is a left side elevational view of FIG. 9.

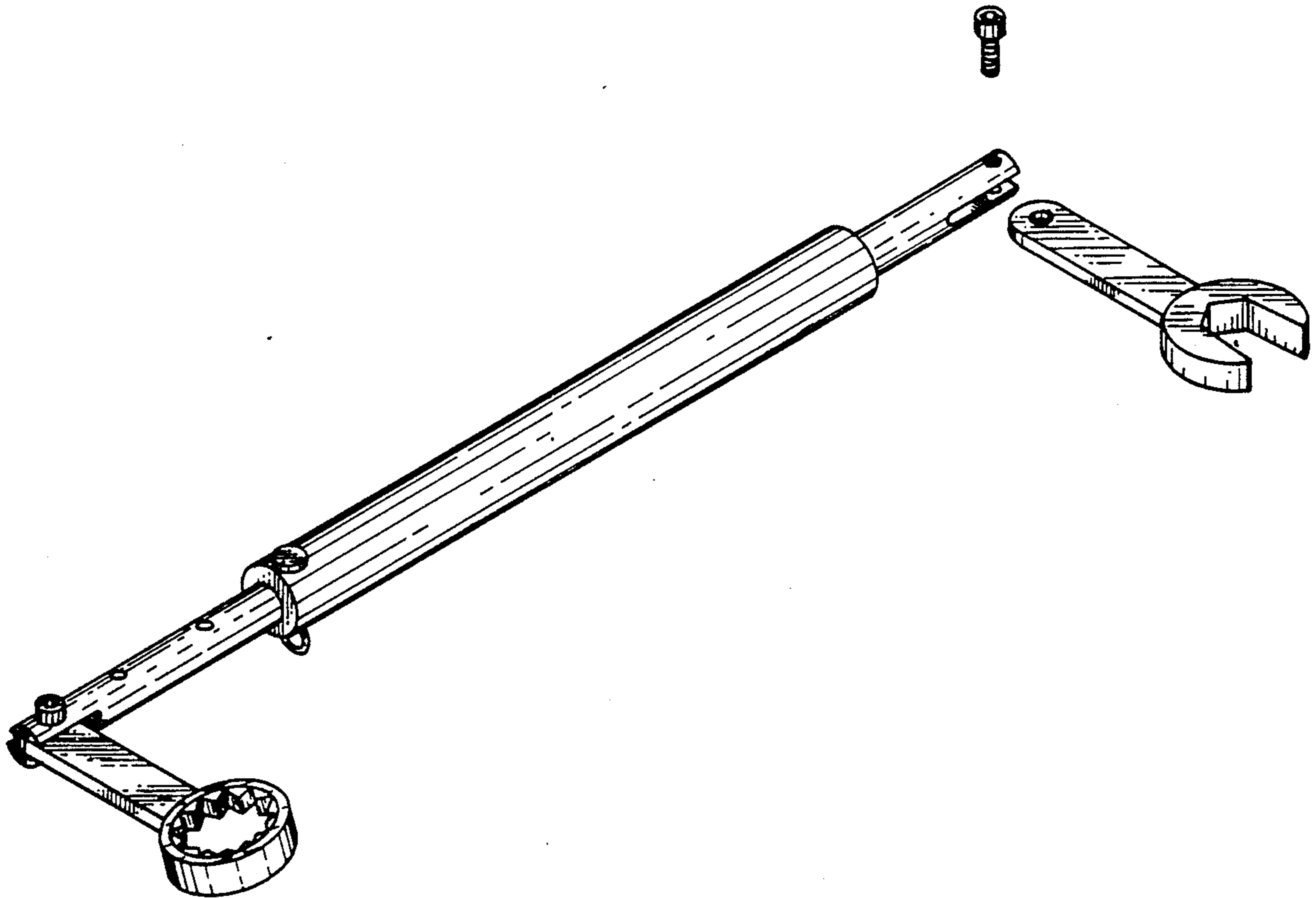

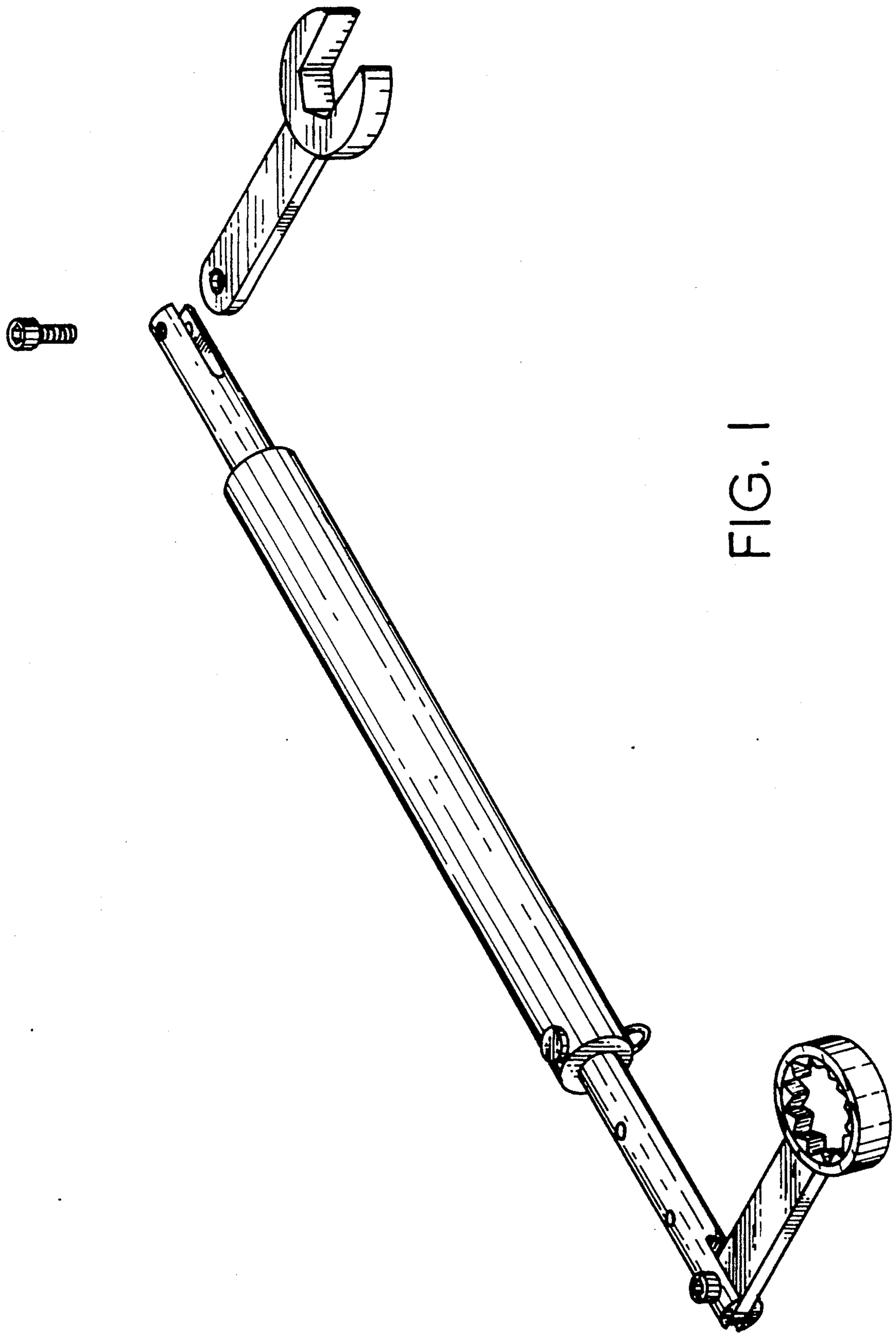

FIG. 1

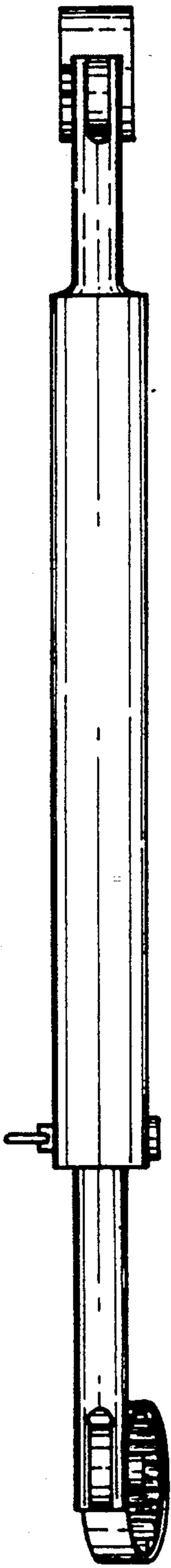

FIG. 2

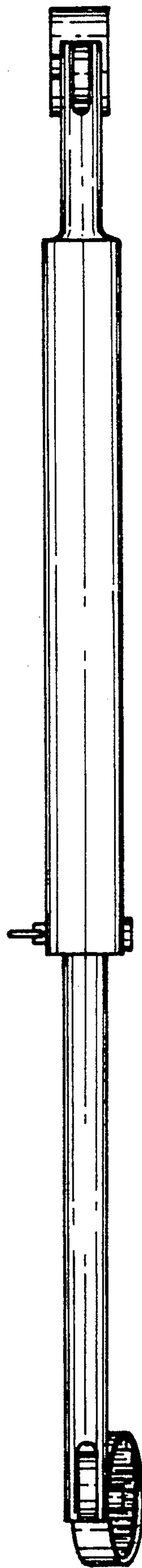
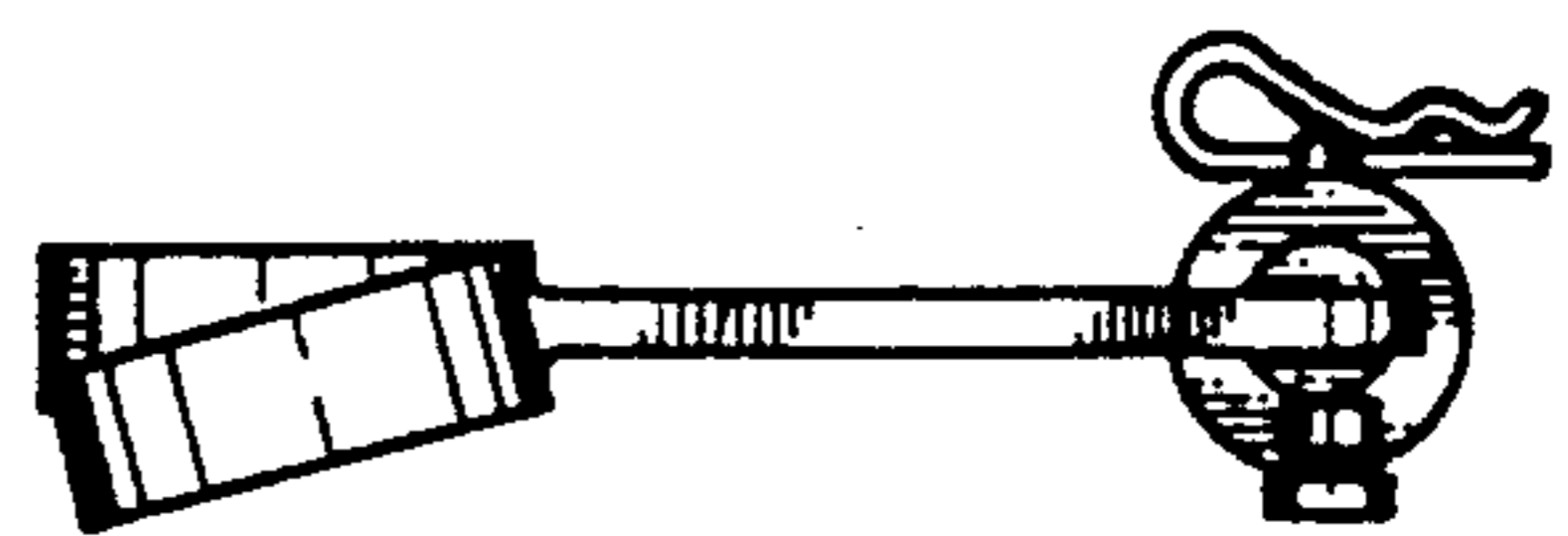
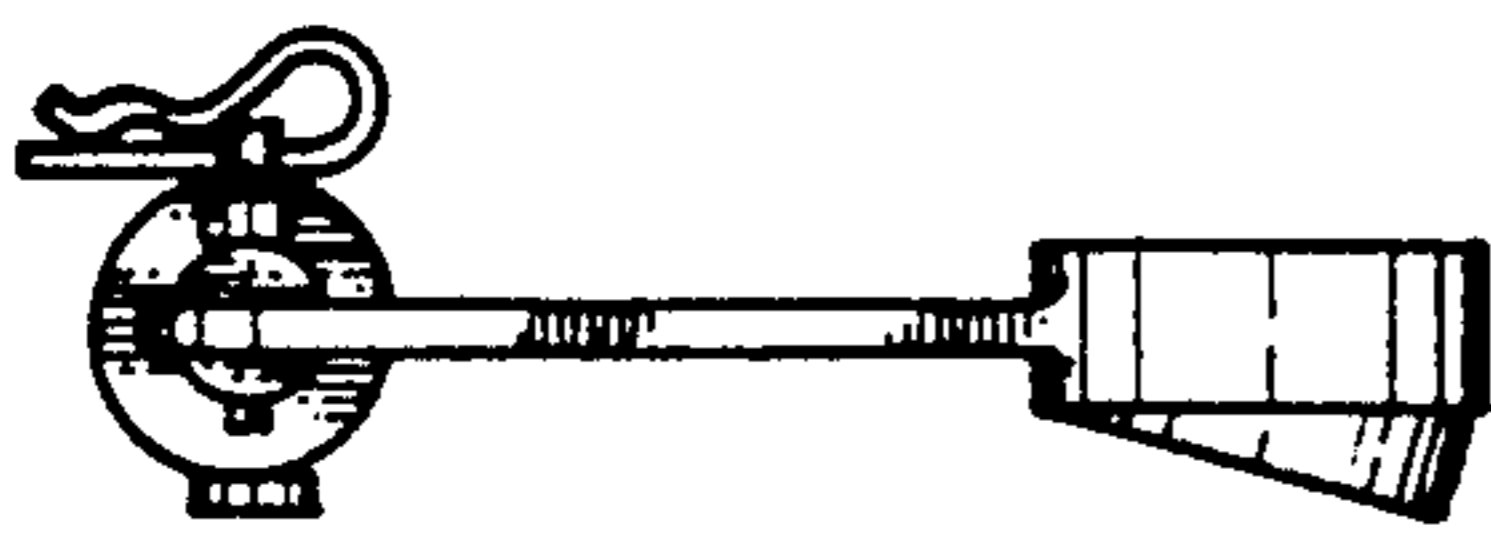
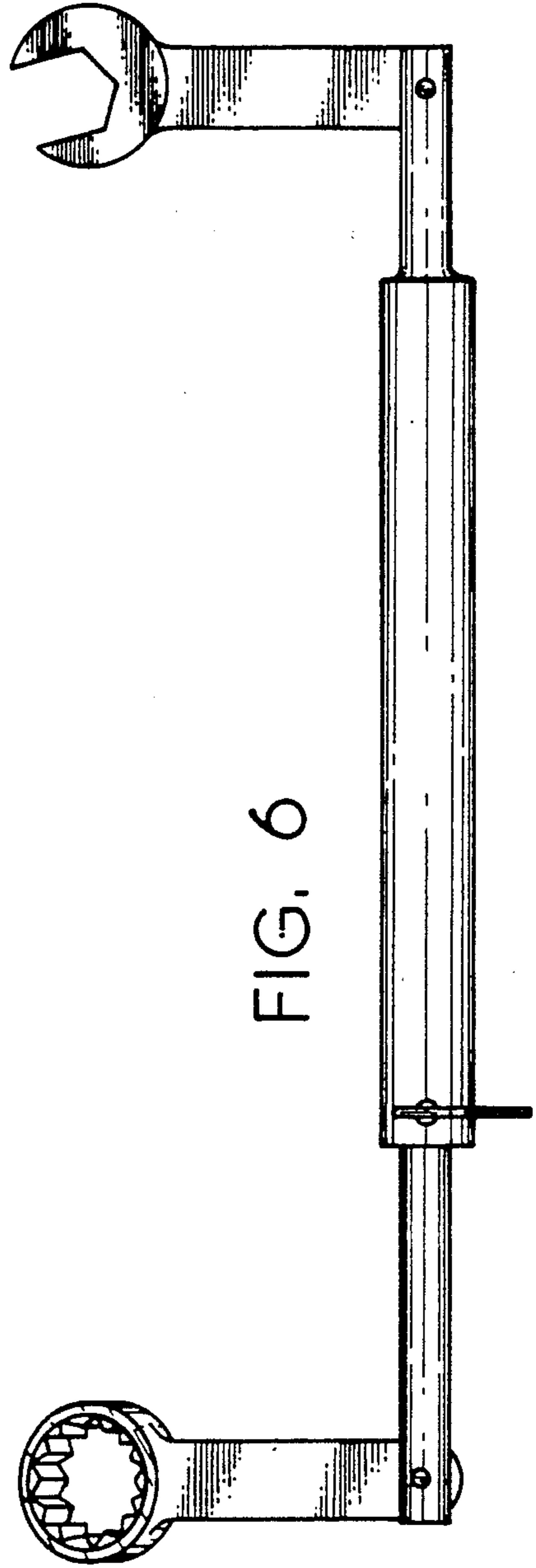
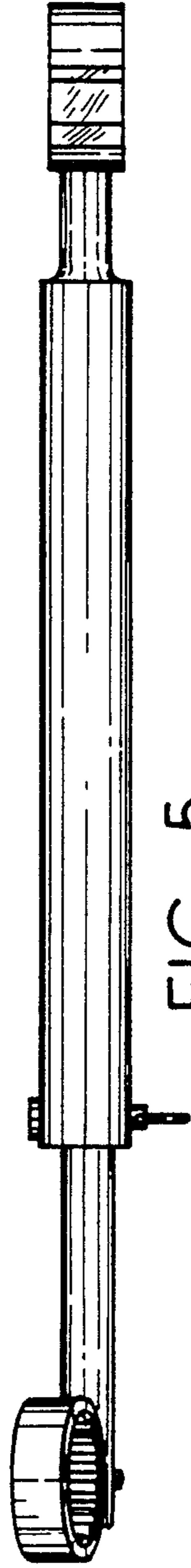
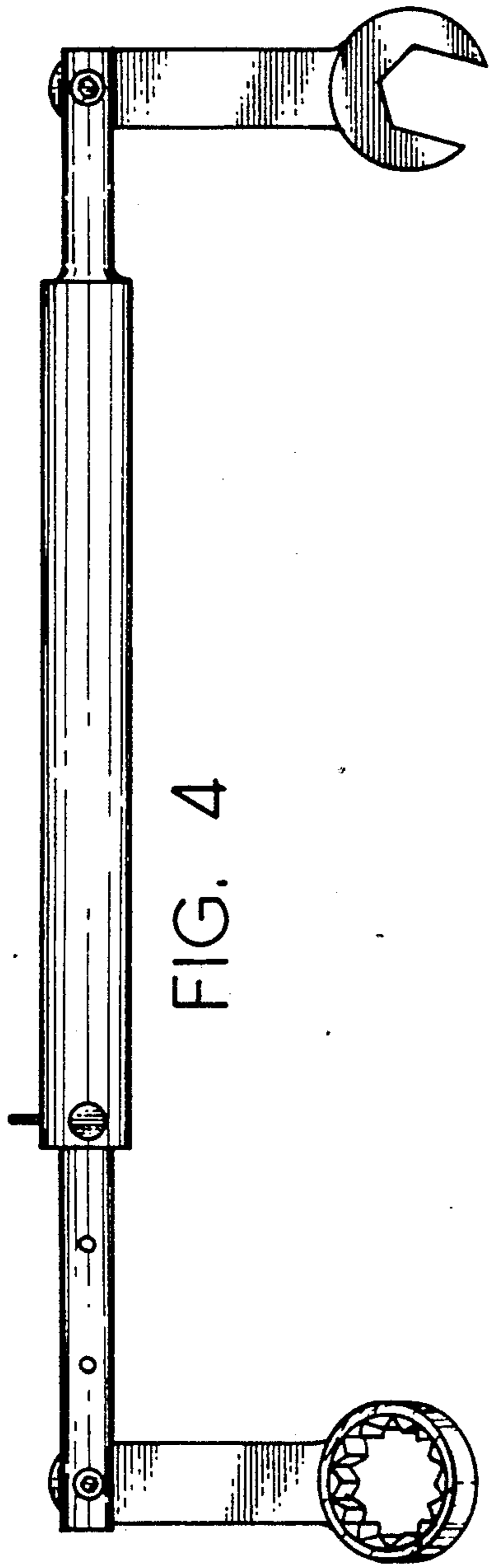

FIG. 3



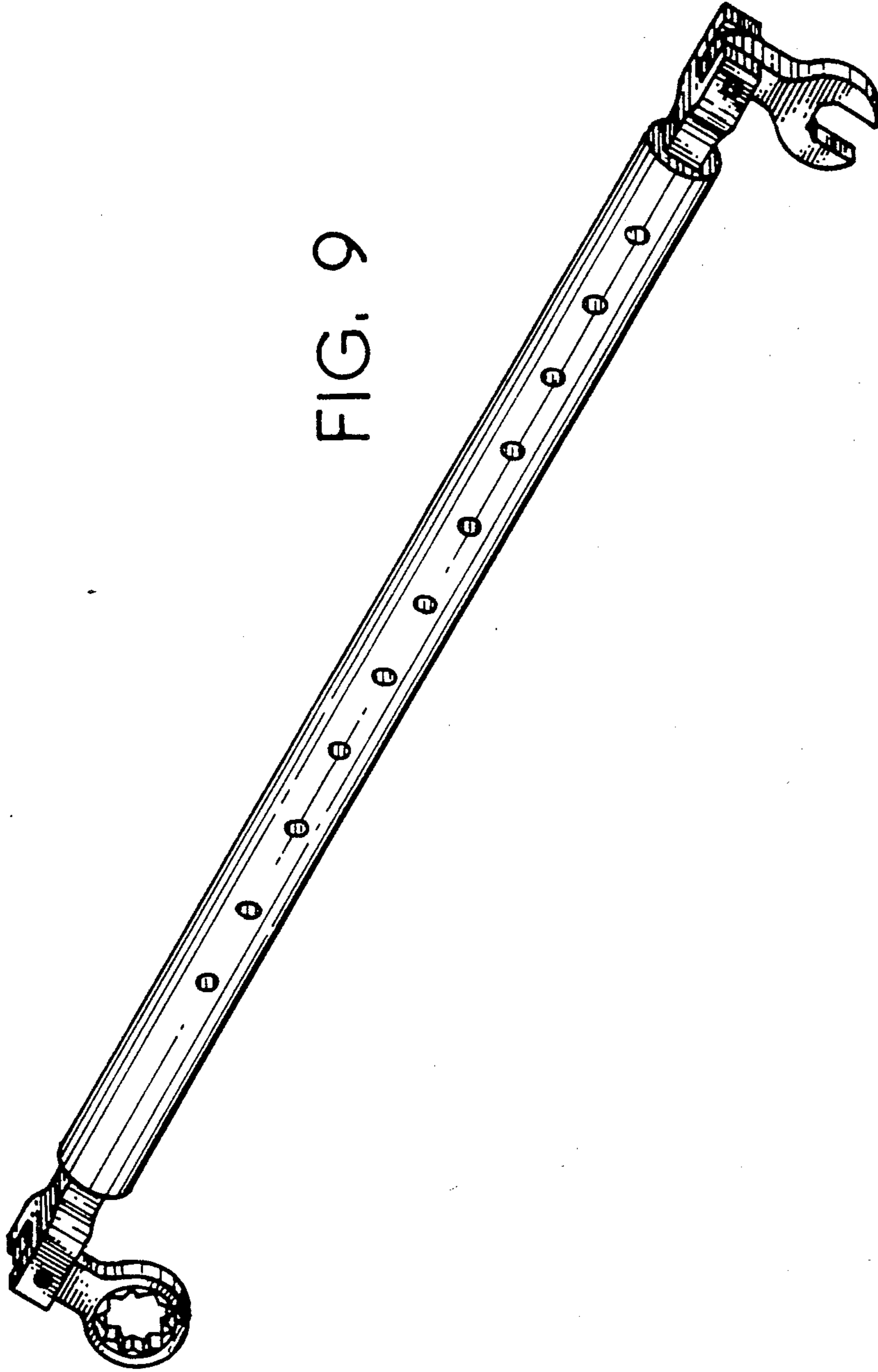

FIG. 9



FIG. 10

FIG. 11

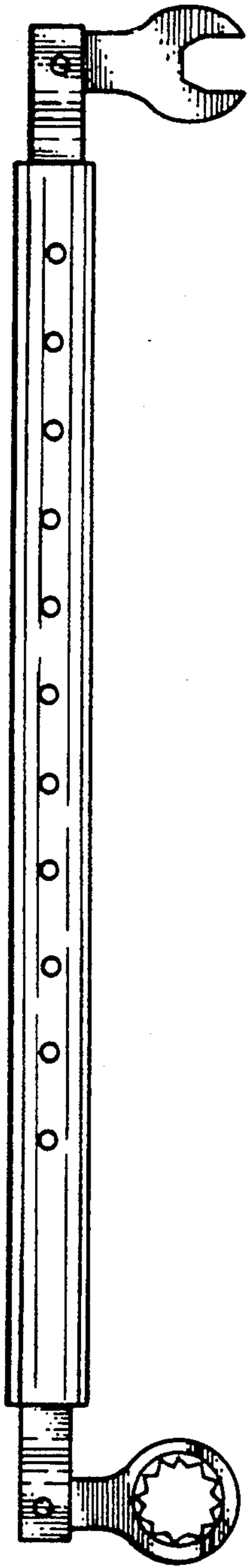

FIG. 14

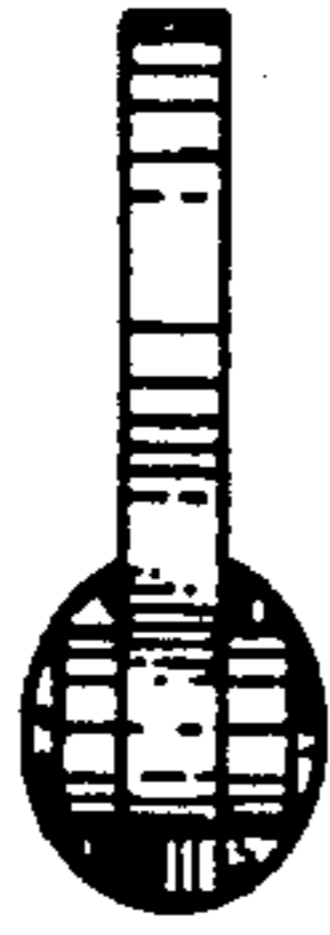

FIG. 12

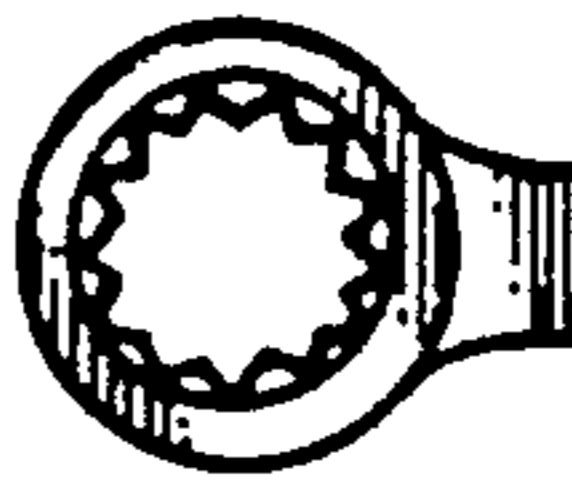

FIG. 13

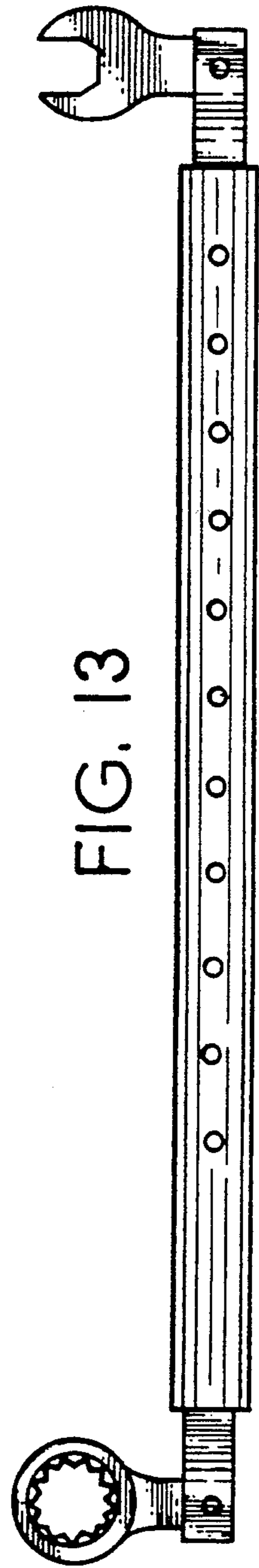

FIG. 15