



US00D325846S

United States Patent [19] Murray

[11] Patent Number: **Des. 325,846**

[45] Date of Patent: **** May 5, 1992**

[54] PORTABLE SANDWICH WARMER

[76] Inventor: **Elbert L. Murray, 4419 Burlingame
Common, Trotwood, Ohio 45426**

[**] Term: **14 Years**

[21] Appl. No.: **420,225**

[22] Filed: **Oct. 12, 1989**

[52] U.S. Cl. **D7/352**

[58] Field of Search **D7/323, 347-350,
D7/352; 219/391, 393; 126/273 R, 275 R, 275
E; 99/331**

[56] References Cited

U.S. PATENT DOCUMENTS

- D. 189,279 11/1960 Beyrodt D7/350
- D. 292,469 10/1987 Nakagawa et al. D7/350

OTHER PUBLICATIONS

Belknap Hardware & Mfg. Co. 1940; p. 1435; Federal #HR 75 Deal; lower right of page.

Primary Examiner—Nelson C. Holtje
Assistant Examiner—Caron D. Veynar
Attorney, Agent, or Firm—Leon Gilden

[57] CLAIM

The ornamental design for a portable sandwich warmer, as shown and described.

DESCRIPTION

FIG. 1 is a front elevational view of a portable sandwich warmer showing my new design; FIG. 2 is a rear elevational view thereof; FIG. 3 is a left side elevational view thereof; FIG. 4 is a right side elevational view thereof; FIG. 5 is a top plan view thereof; and, FIG. 6 is a bottom plan view thereof.

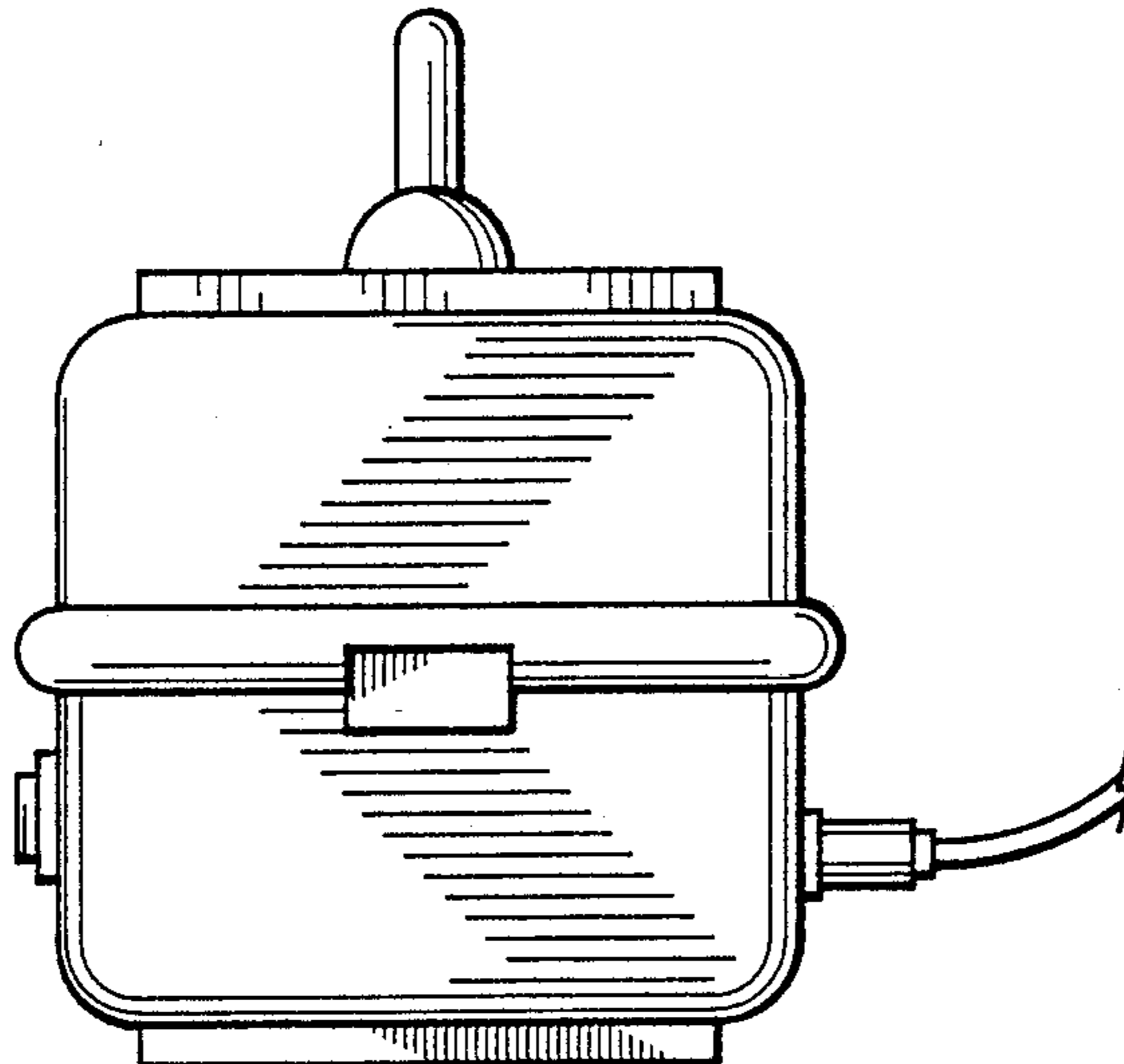
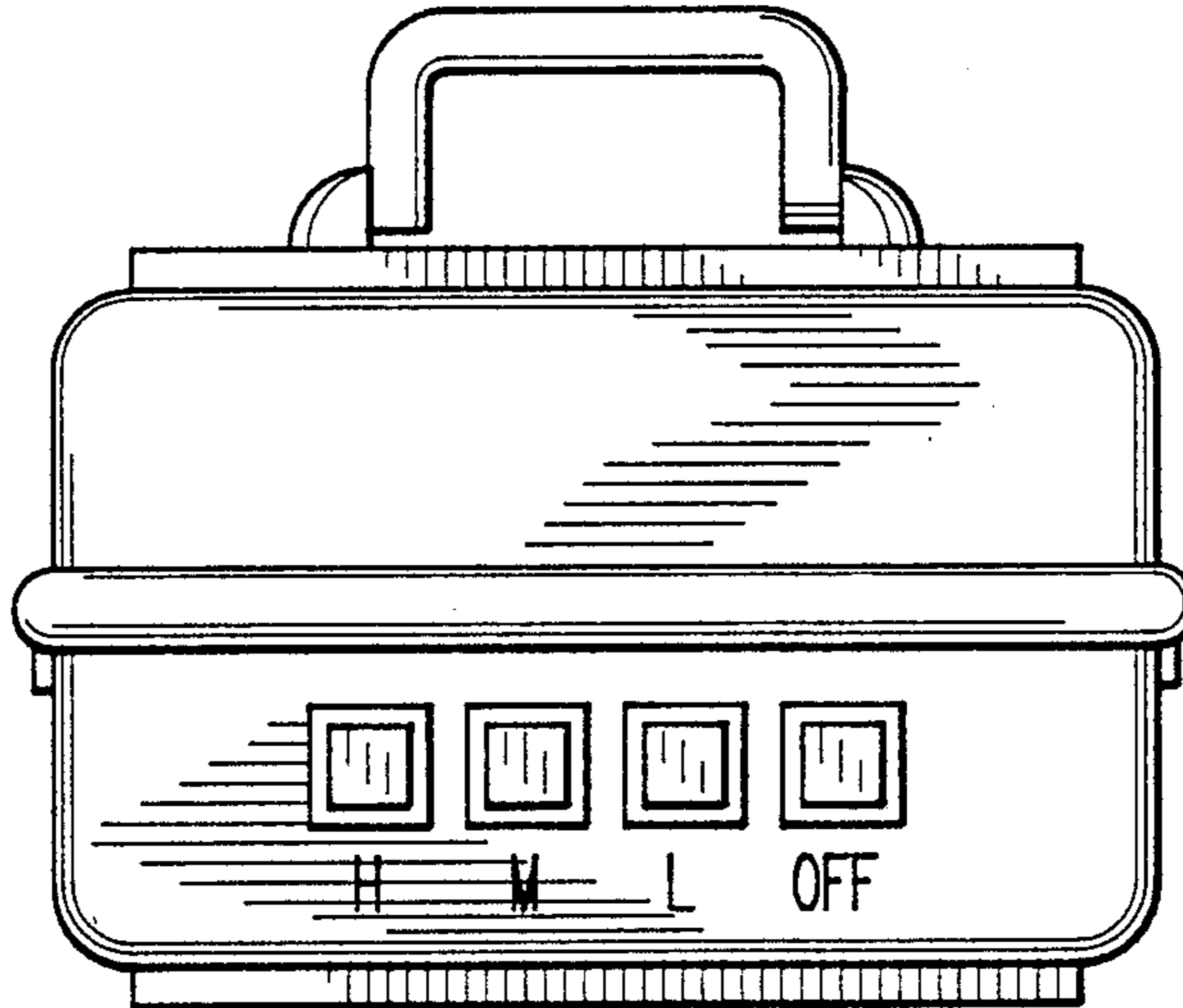

Fig. 1

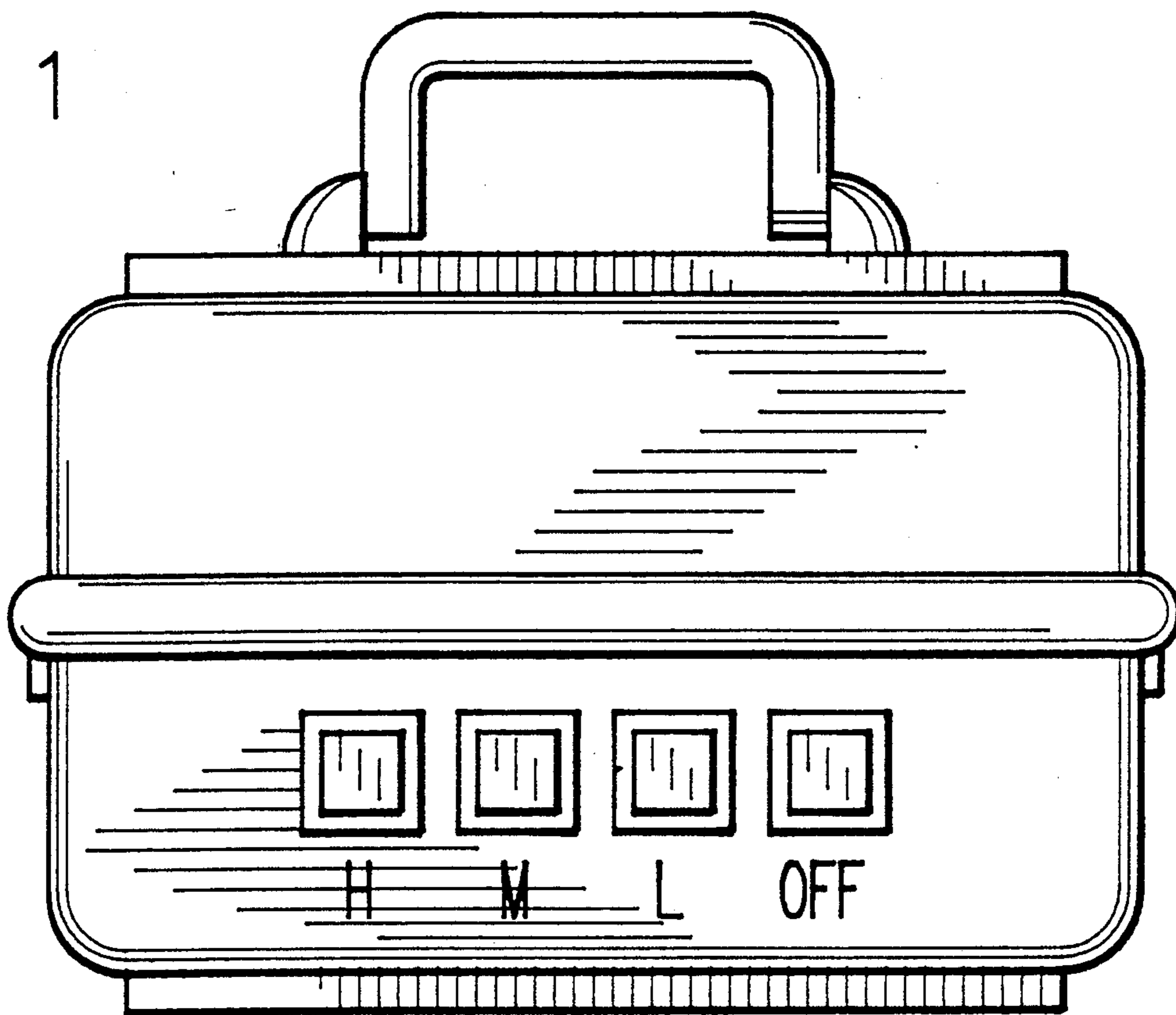
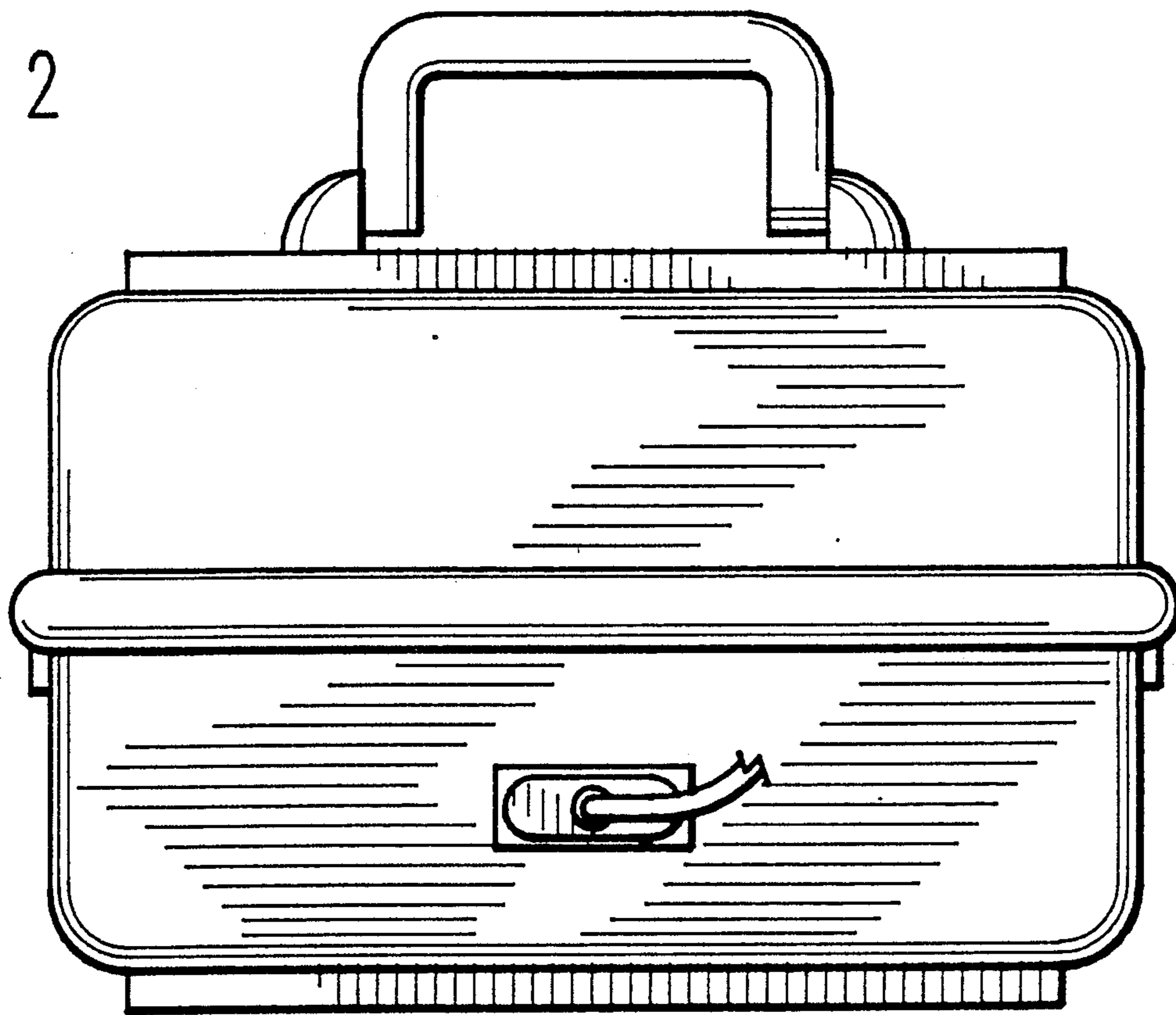

Fig. 2



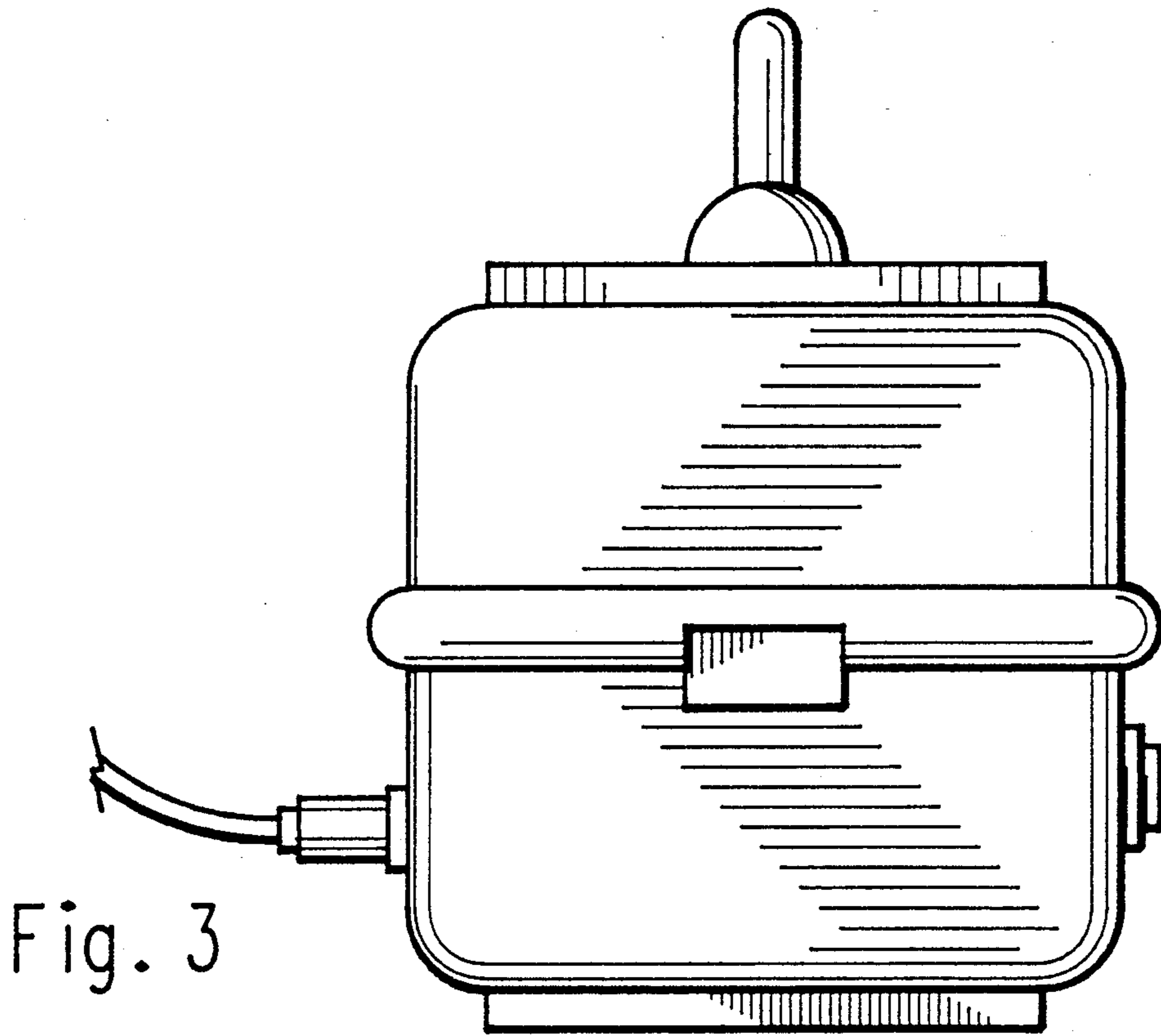

Fig. 3

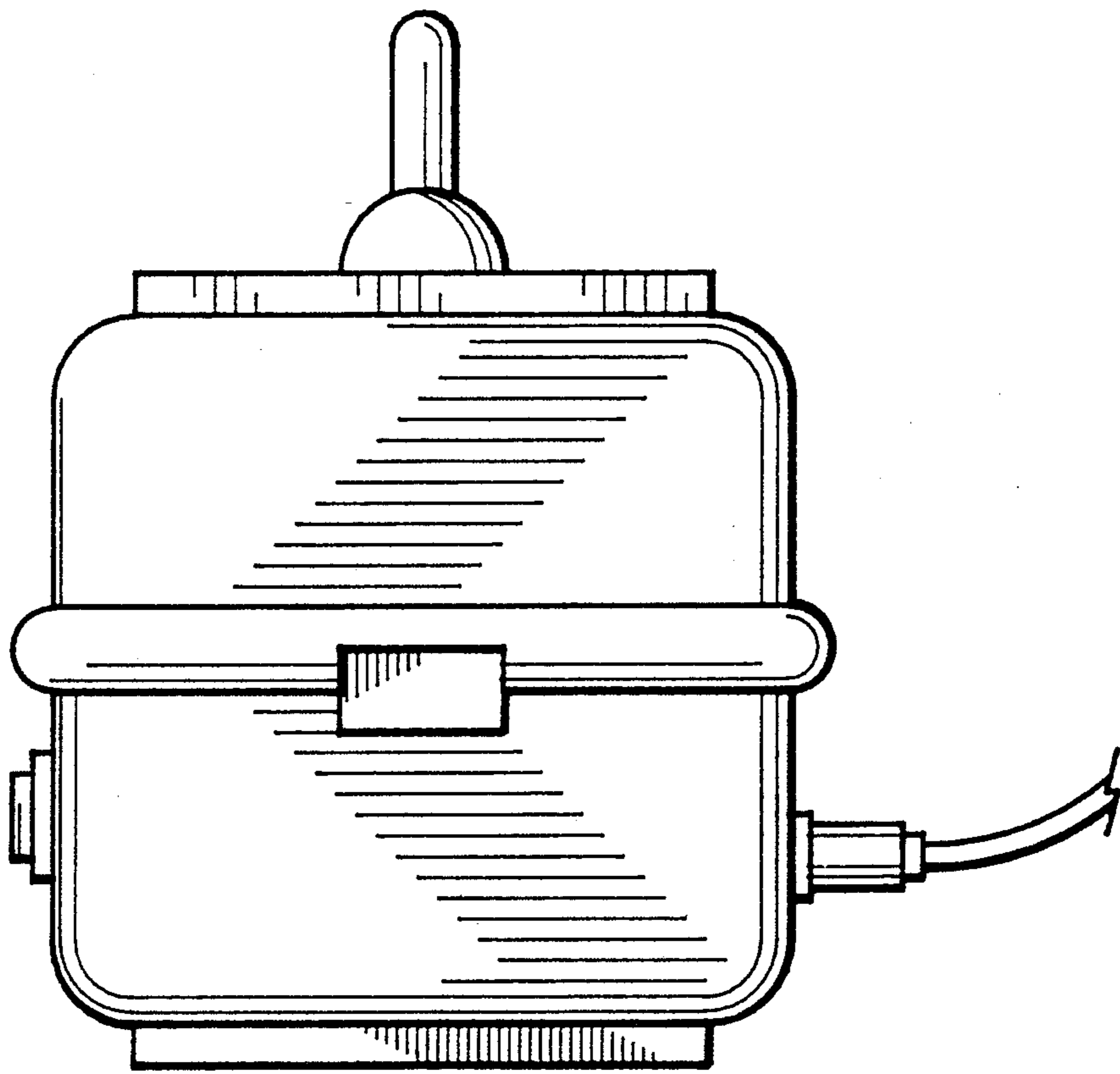

Fig. 4

Fig. 5

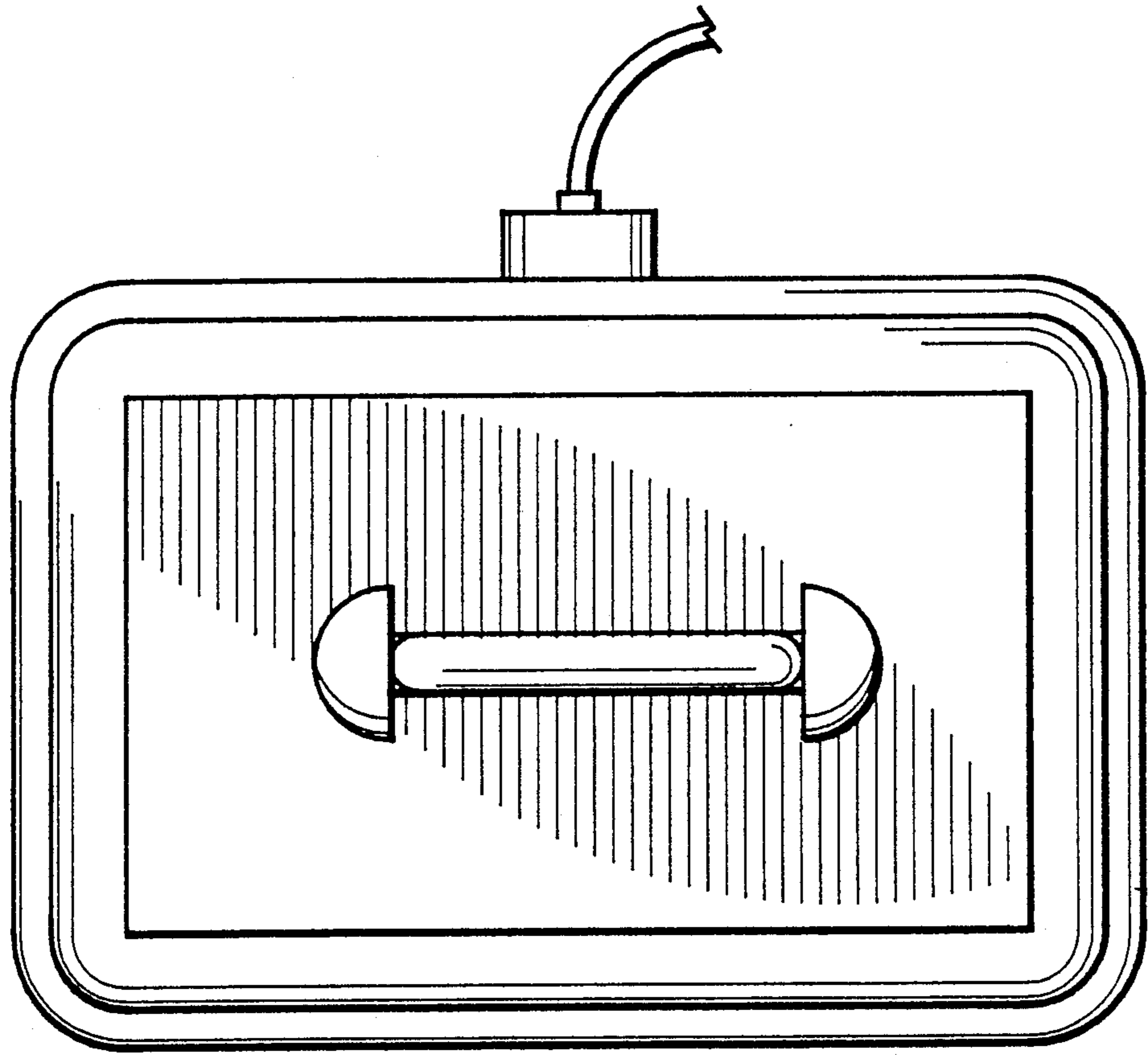

Fig. 6

