



US00D325775S

United States Patent [19]

Hayes

[11] Patent Number: **Des. 325,775**

[45] Date of Patent: **** Apr. 28, 1992**

[54] **HOSE QUICK CONNECTOR HOUSING**

[75] Inventor: **Ronald G. Hayes, Milford, Ohio**

[73] Assignee: **L. R. Nelson Corporation, Peoria, Ill.**

[**] Term: **14 Years**

[21] Appl. No.: **423,852**

[22] Filed: **Oct. 19, 1989**

[52] U.S. Cl. **D23/262**

[58] Field of Search **D23/259-269;**
285/33-35, 256, 258, 262, 315, 353-354,
386-387

3,390,898 7/1968 Sumida 285/34
3,799,453 3/1974 Hart 285/33 X

Primary Examiner—Brian N. Vinson
Attorney, Agent, or Firm—Cushman, Darby & Cushman

[57] CLAIM

The ornamental design for a hose quick connector housing, as shown and described.

DESCRIPTION

FIG. 1 is a top, front, and left side perspective view of a hose quick connector housing showing my new design;

FIG. 2 is an enlarged left side elevational view thereof, the right side being a mirror image thereof;

FIG. 3 is an enlarged front elevational view thereof;

FIG. 4 is an enlarged top plan view thereof, the bottom being identical in appearance; and,

FIG. 5 is an enlarged rear elevational view thereof.

The broken-line disclosure of internal features is for illustrative purposes only and forms no part of the claimed design.

[56] References Cited

U.S. PATENT DOCUMENTS

D. 221,432	8/1971	Dunlap	D23/262
D. 229,496	12/1973	Hand	D23/262
D. 254,802	4/1980	Hayes	D23/262
D. 299,267	1/1989	Roman	D23/262
D. 314,814	2/1991	Lubeck	D23/262
3,162,470	12/1964	Davidson et al.	D23/262 X

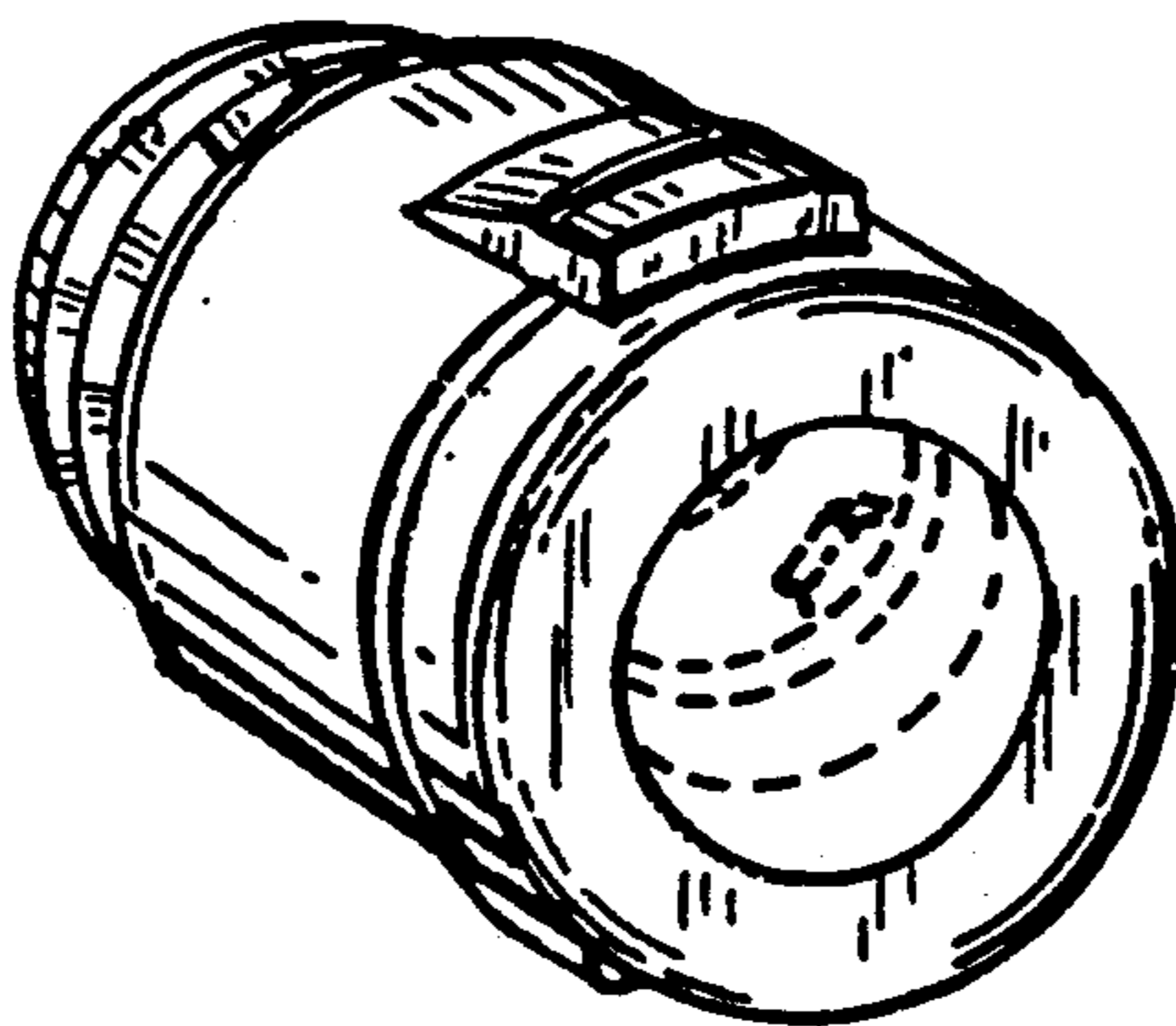
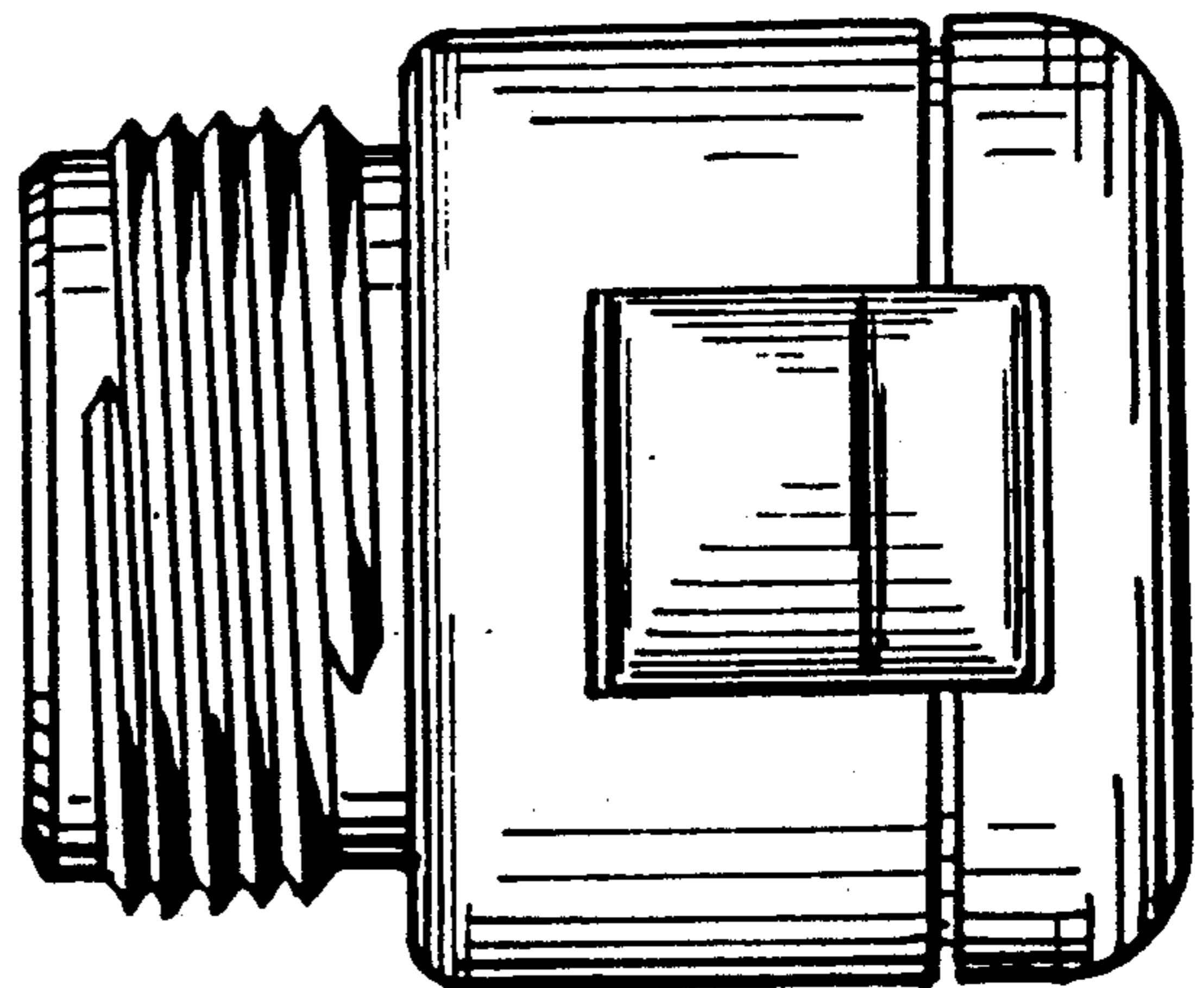
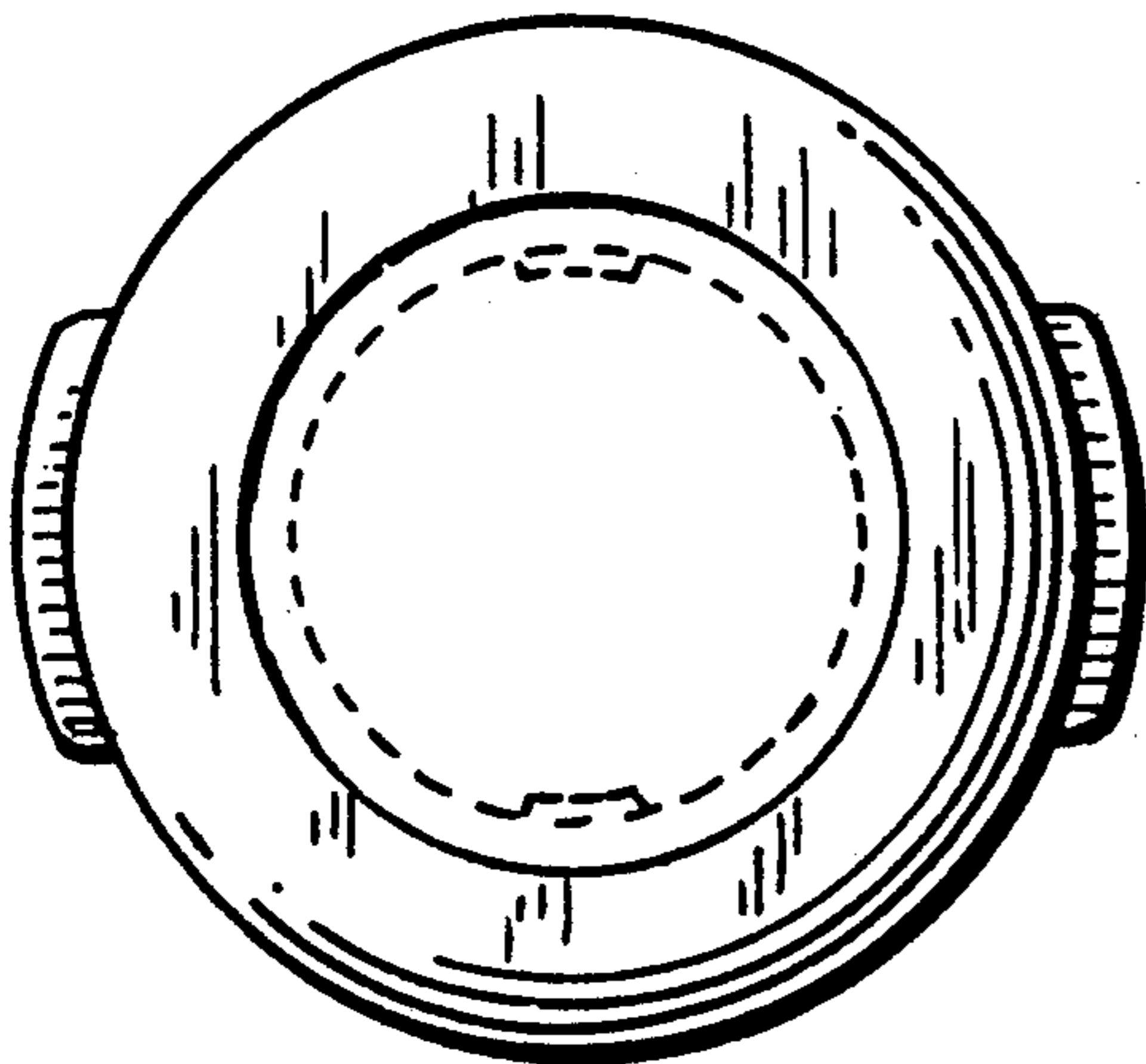

Fig. 4.

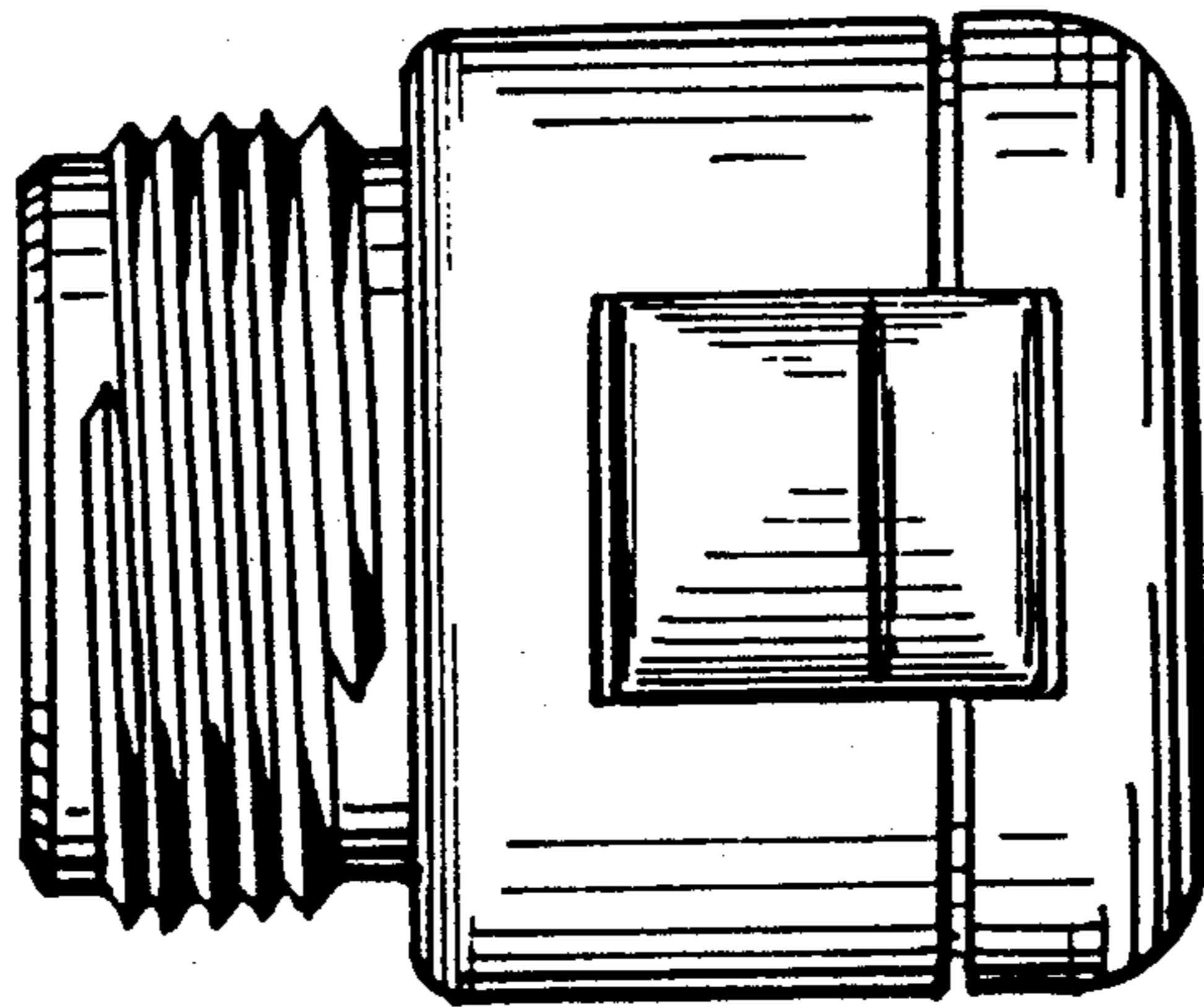

Fig. 3.

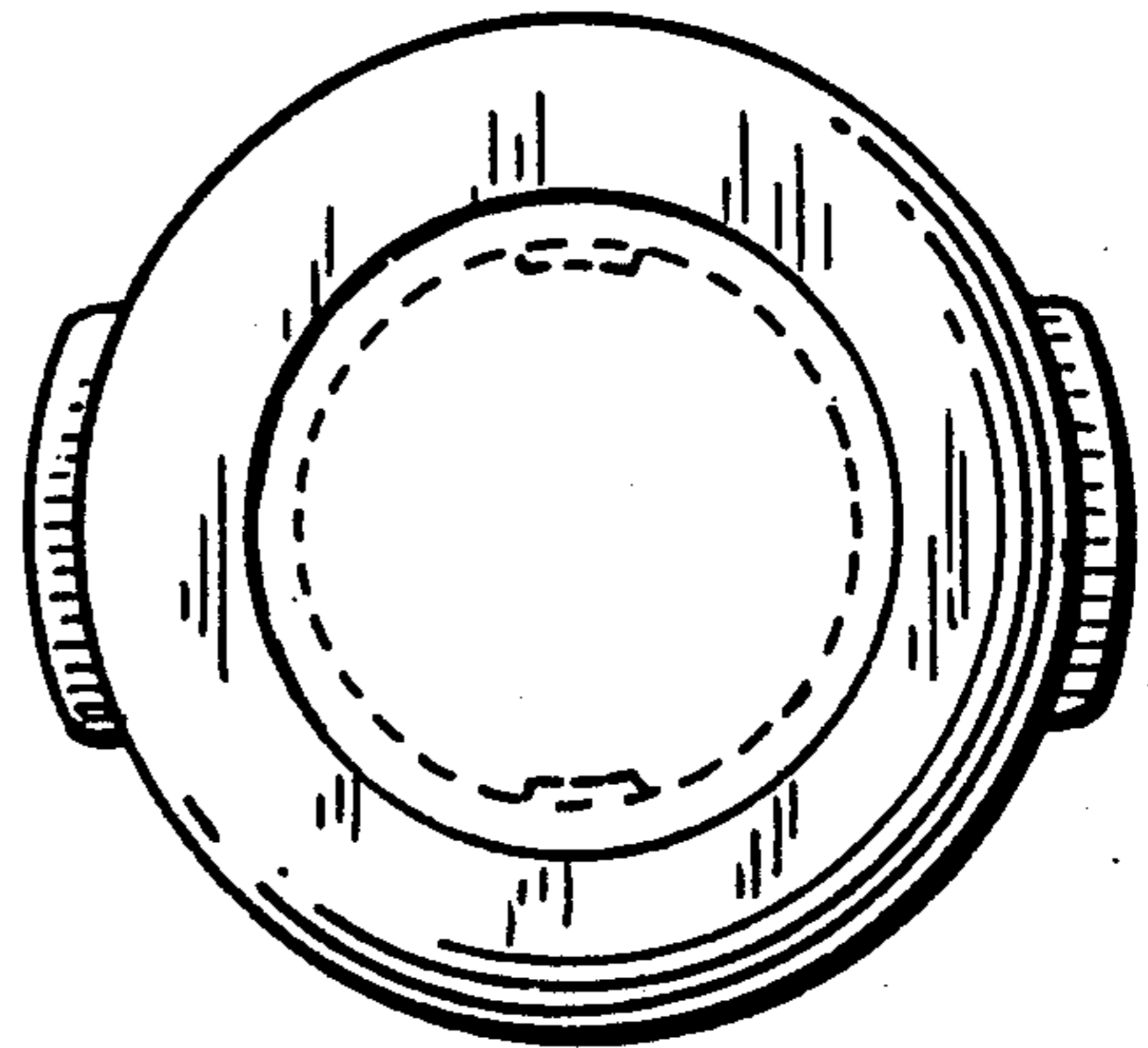

Fig. 2.

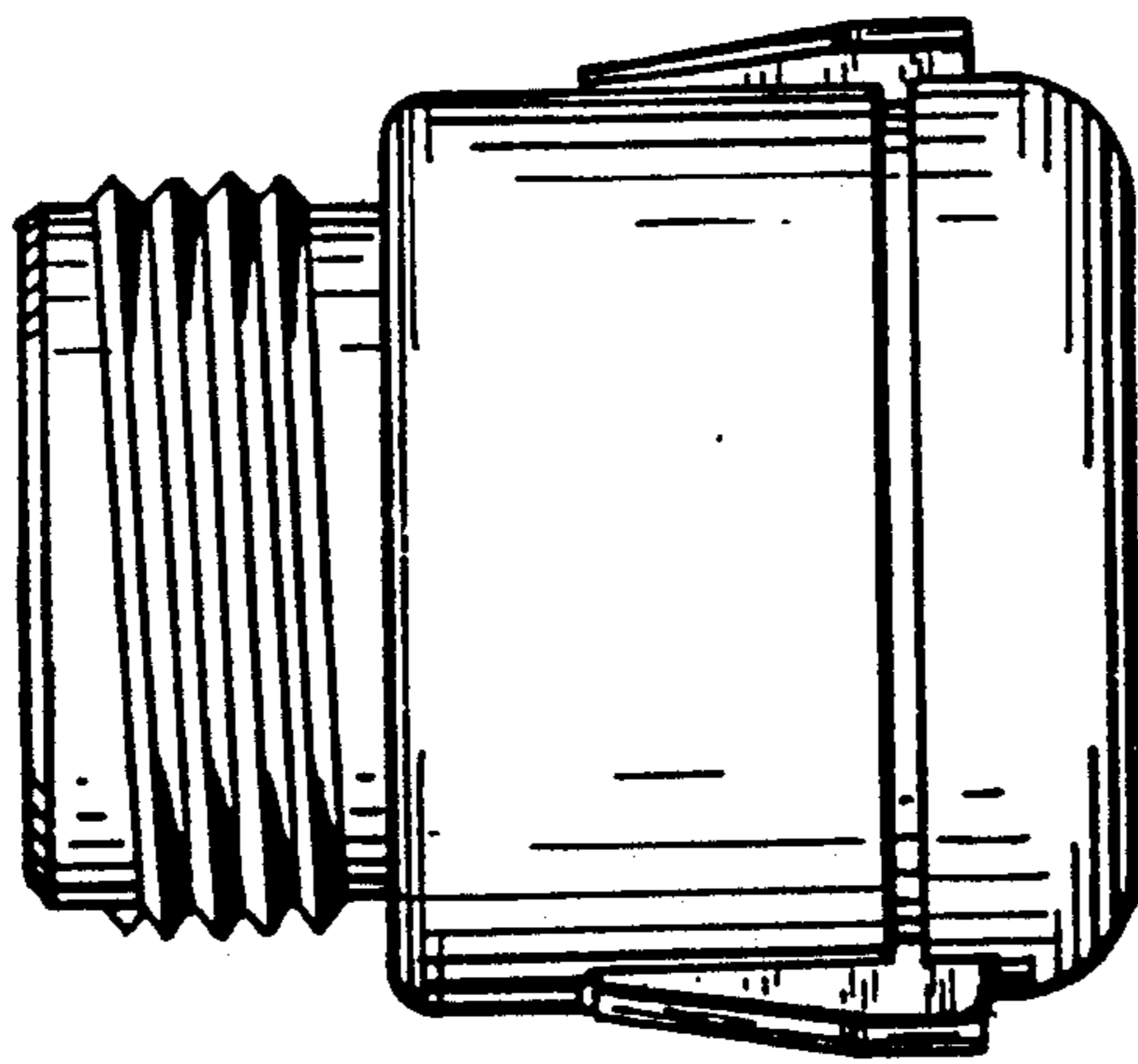

Fig. 5.

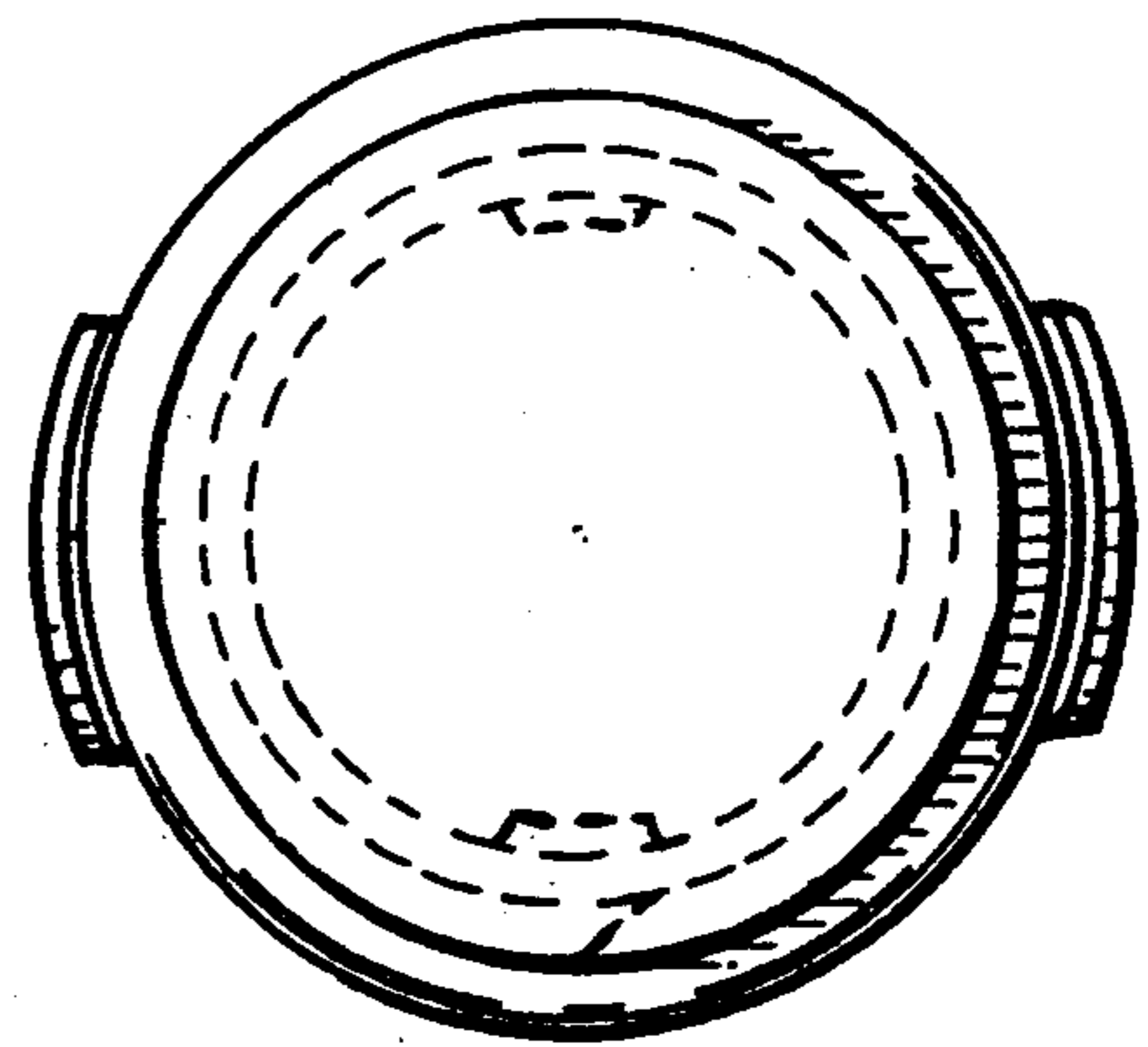

Fig. 1.

