



US00D325765S

United States Patent [19]

[11] Patent Number: **Des. 325,765**

Grantz et al.

[45] Date of Patent: **** Apr. 28, 1992**

[54] **SPRING SUPPORT FOR SKI SEAT OR SIMILAR ARTICLE**

[76] Inventors: **Kenneth R. Grantz**, 939 Crystal Dr., Jenison, Mich. 49428; **Richard A. Kwekel**, 3913 Hazelwood, S. W.; **Christopher A. Kwekel**, 3919 Hazelwood, S. W., both of Wyoming, Mich. 49509

3,190,668 6/1965 Husak .
3,297,334 12/1965 Jenks .
3,744,811 7/1973 Johnston .
4,199,162 4/1980 Joy .
4,310,169 1/1982 Brough .

[**] Term: **14 Years**

FOREIGN PATENT DOCUMENTS

[21] Appl. No.: **507,292**

811624 4/1969 Canada .
389420 7/1965 Switzerland .
568183 10/1974 Switzerland .

[22] Filed: **Apr. 9, 1990**

Primary Examiner—Charles A. Rademaker
Attorney, Agent, or Firm—Varnum, Riddering, Schmidt & Howlett

[52] U.S. Cl. **D21/230**

[58] Field of Search **D21/224, 229, 230;**
D6/362, 364, 462, 500; 280/601, 607, 11.14,
11.18, 28.14, 25

[57] CLAIM

The ornamental design for a spring support for ski seat or similar article, as shown and described.

[56] References Cited

U.S. PATENT DOCUMENTS

D. 133,351	8/1942	Schlappritz	D6/500
D. 146,626	4/1947	Turner	.	
D. 157,137	2/1950	Foster	.	
D. 162,423	3/1951	Kotchan	D21/229
D. 184,499	2/1959	Van Slooten	.	
D. 205,297	7/1966	Cohen	.	
D. 223,267	4/1972	Molzen et al.	D21/229
D. 228,717	10/1973	Kramer	D6/501
D. 232,164	7/1974	Bemis, II et al.	.	
2,460,815	2/1949	Dunkel	.	

DESCRIPTION

FIG. 1 is a perspective view of a spring support for ski seat or similar article showing our new design; FIG. 2 is a right side elevational view thereof, the left side elevational view being a mirror image; FIG. 3 is a top plan view thereof; FIG. 4 is a bottom plan view thereof; FIG. 5 is a front elevational view thereof; and, FIG. 6 is a rear elevational view thereof. The broken lines showing a ski and a seat in the drawings represent environment only and form no part of the claimed design.

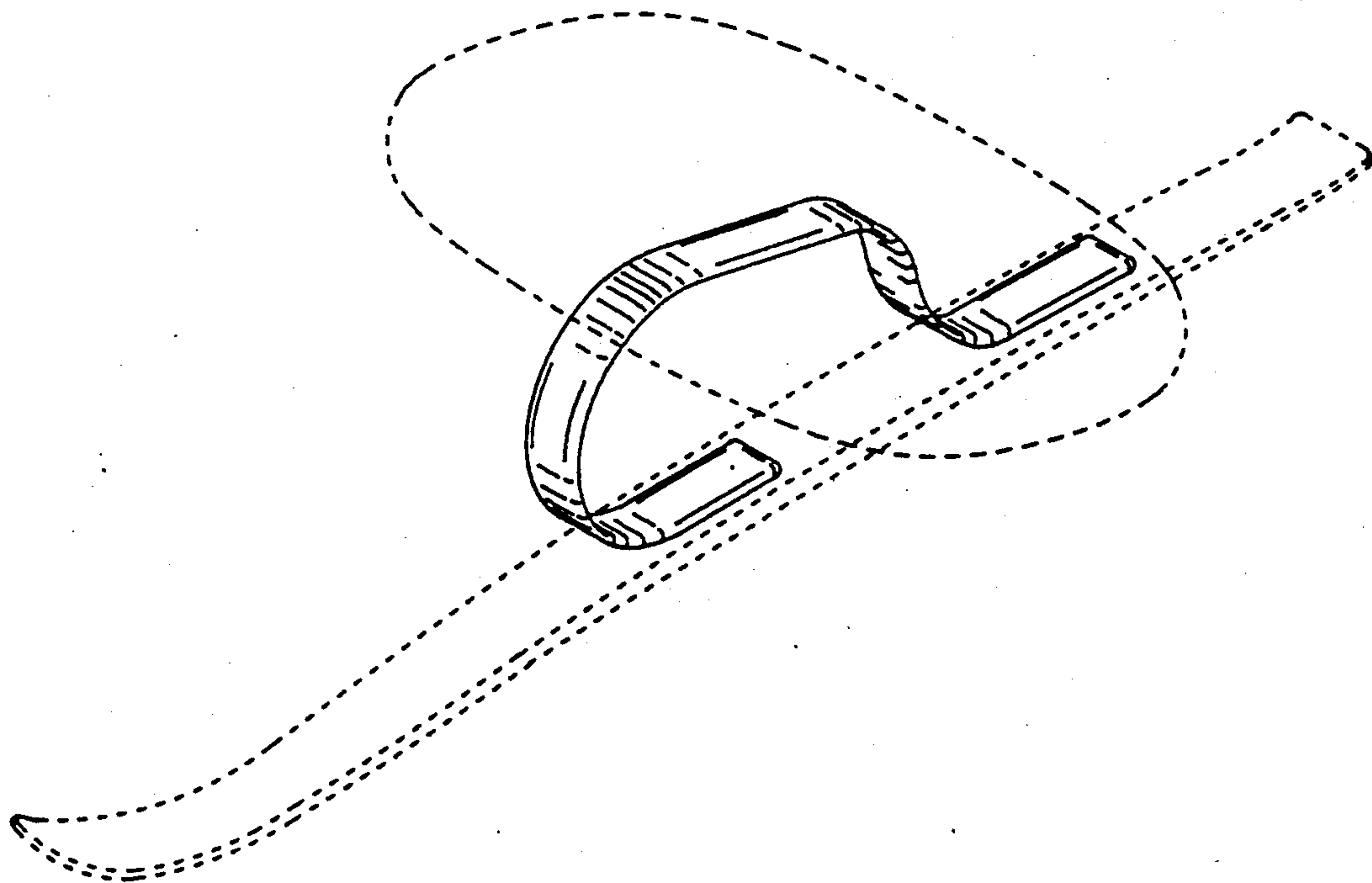

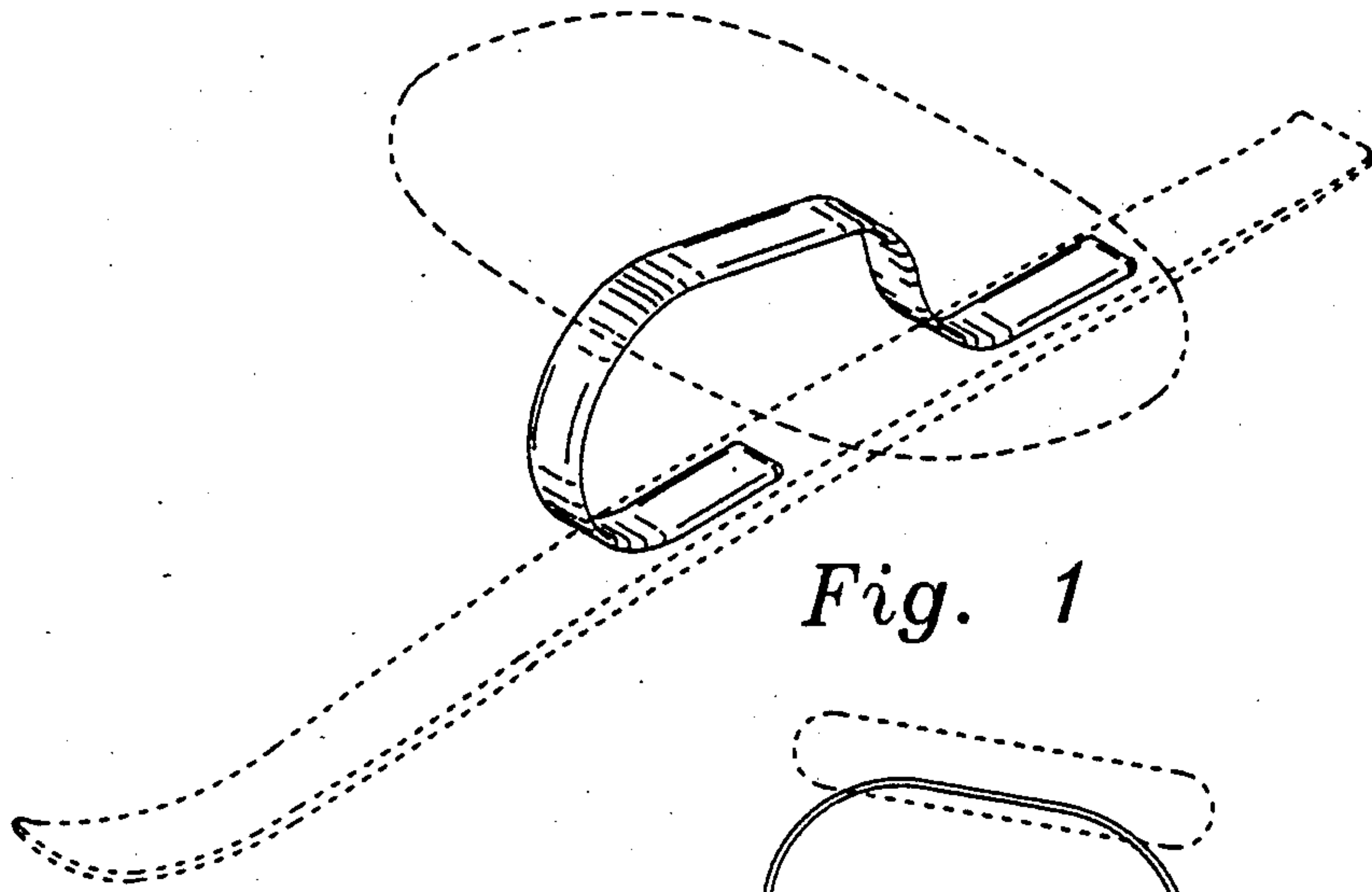

Fig. 1

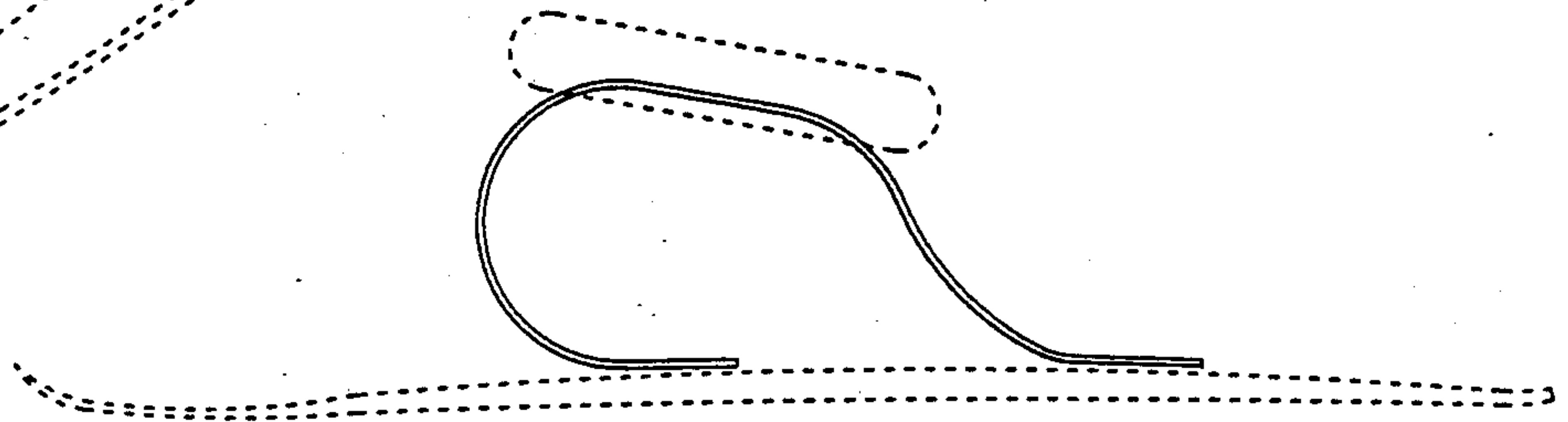

Fig. 2

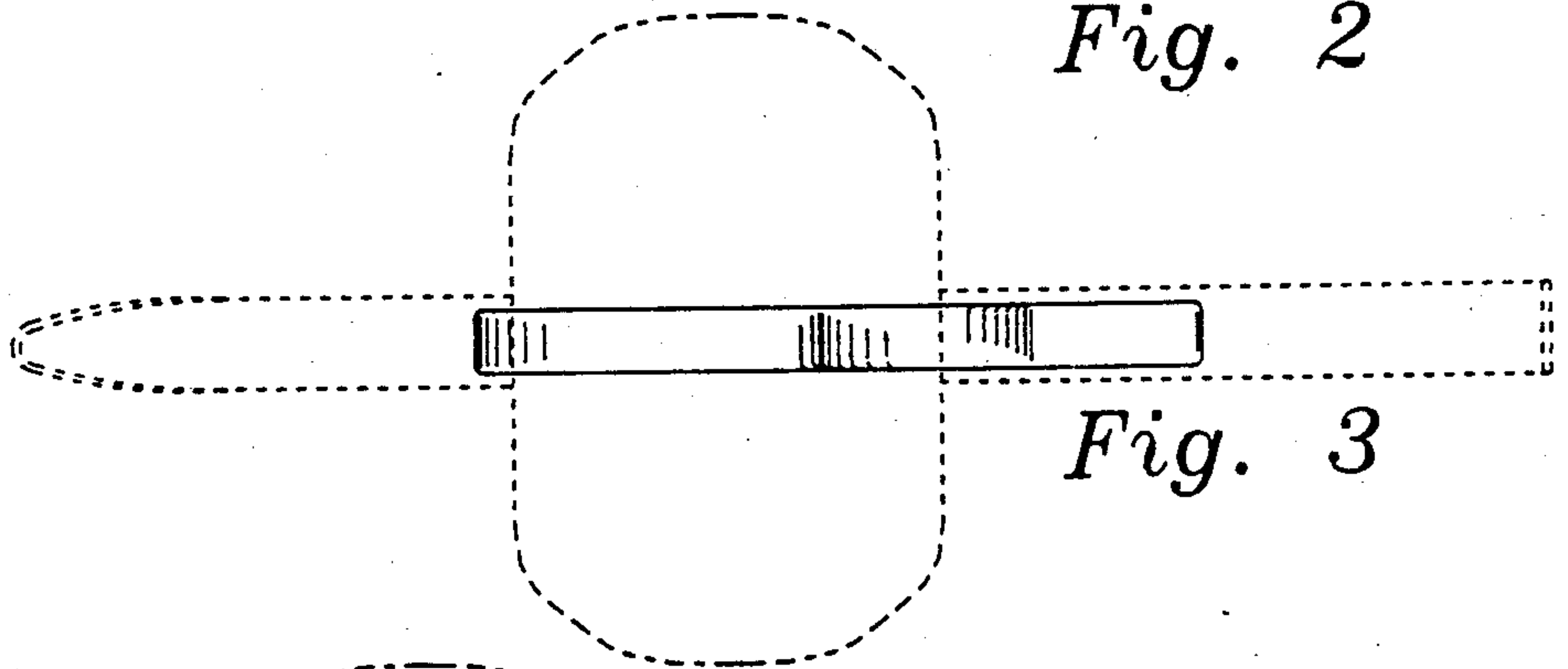

Fig. 3

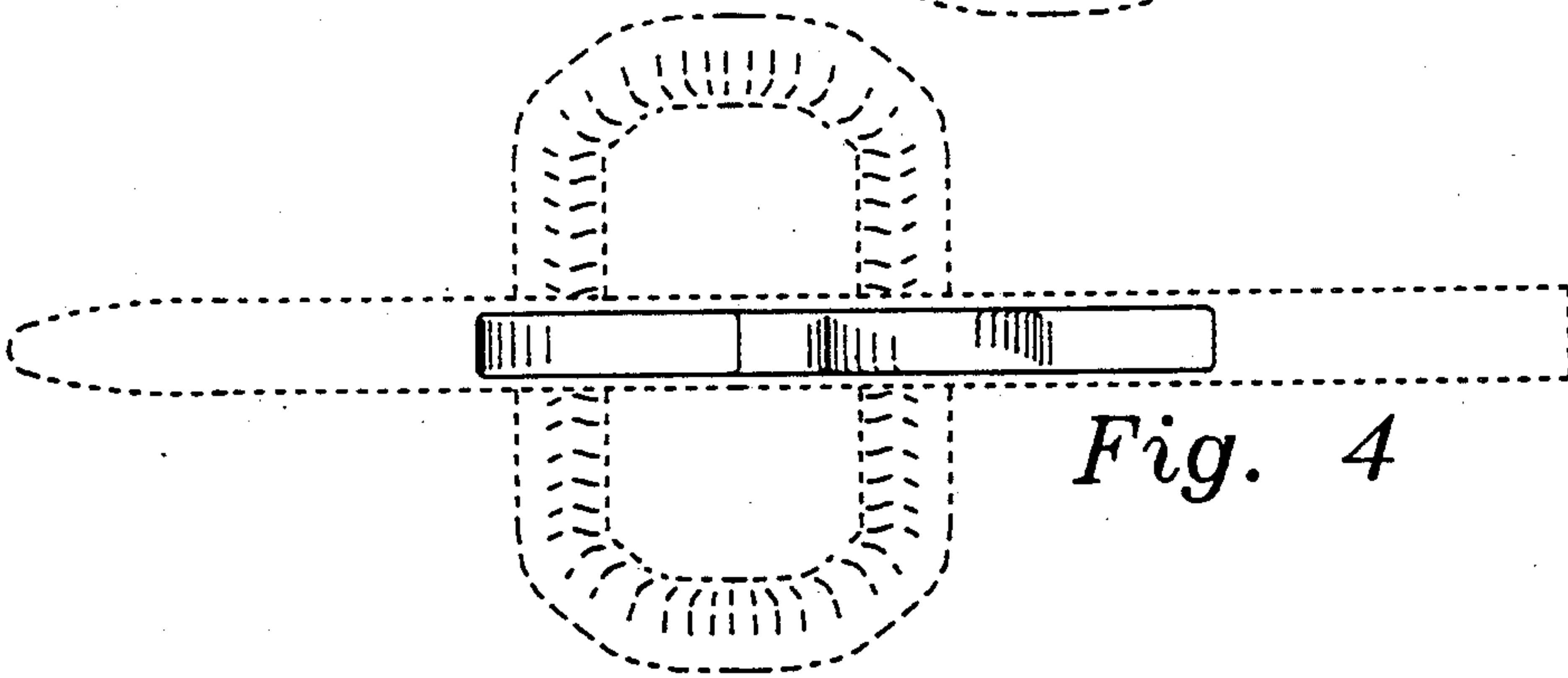

Fig. 4

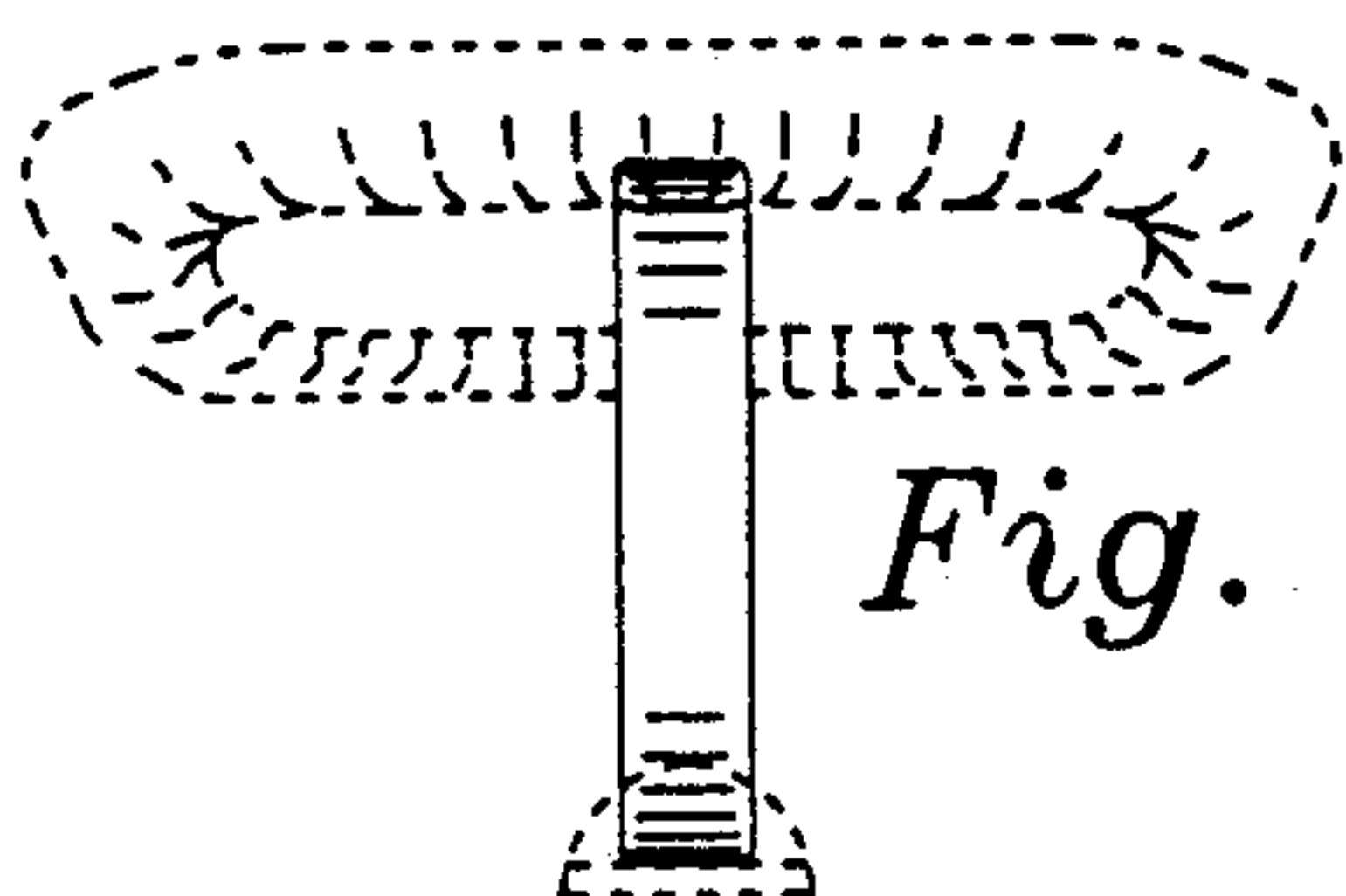

Fig. 5

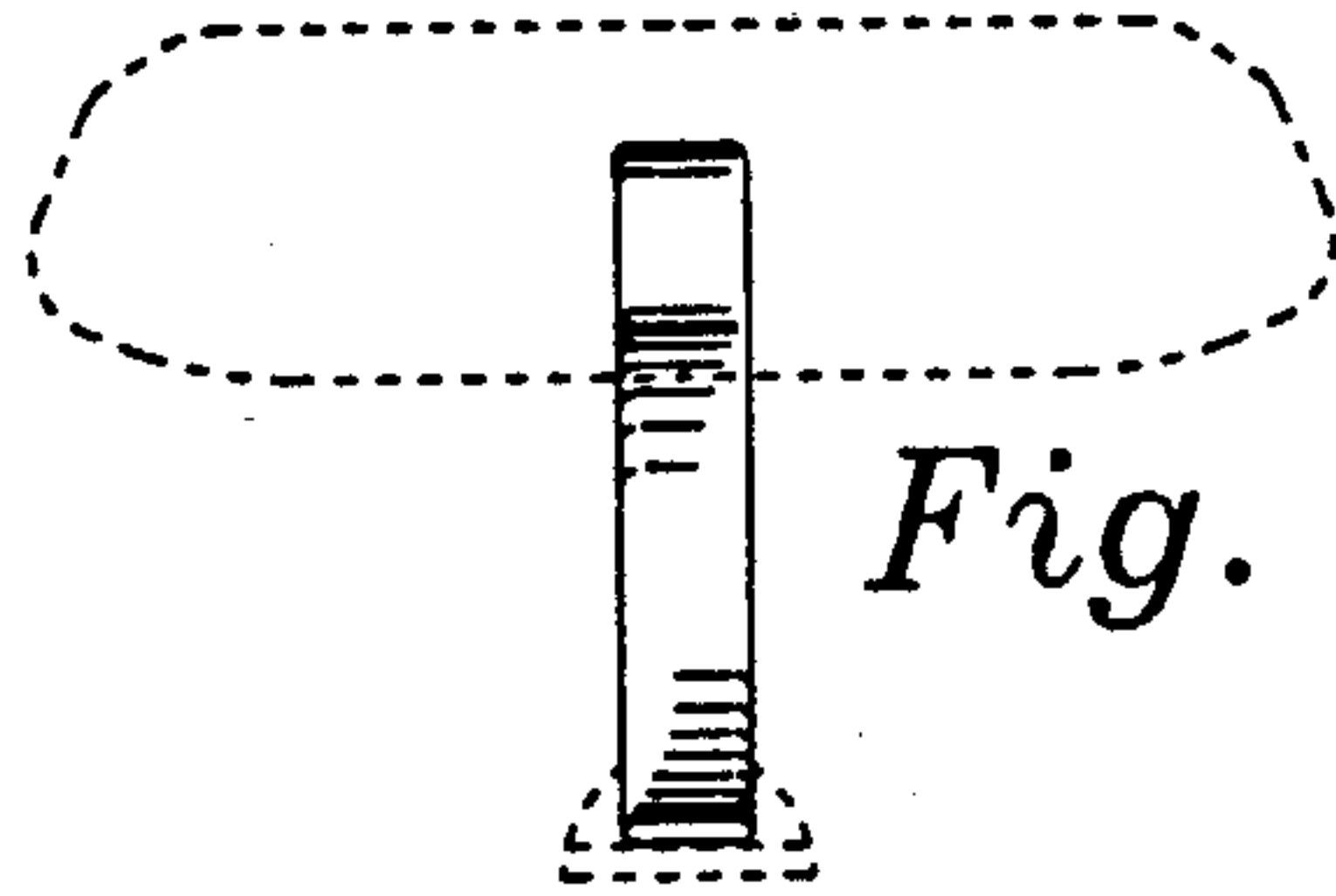

Fig. 6