



US00D325601S

United States Patent [19]

[11] Patent Number: **Des. 325,601**

Chen

[45] Date of Patent: **** Apr. 21, 1992**

[54] **COMBINED FILE CARD HOLDER AND CALCULATOR**

[75] Inventor: **Kin-Lung Chen, Taipei, Taiwan**

[73] Assignee: **Muzex Inc., Taipei, Taiwan**

[**] Term: **14 Years**

[21] Appl. No.: **443,638**

[22] Filed: **Nov. 29, 1989**

[52] U.S. Cl. **D19/76; D19/75; D19/86; D19/90; D18/7**

[58] Field of Search **D3/30.1, 35; D19/65, D19/75, 76, 86, 90, 91, 95, 99, 100; 206/424, 444, 387; 211/10, 11, 45, 50; D18/7**

[56] **References Cited**

U.S. PATENT DOCUMENTS

D. 285,094	8/1986	Li	D19/77 X
D. 291,386	8/1987	Johansson	D3/35
D. 303,873	10/1989	Brüssing	D3/35
D. 308,914	7/1990	Chow	D3/35
D. 309,213	7/1990	Chaney	D3/35
D. 309,626	7/1990	Sakaguchi et al.	D18/7
D. 312,839	12/1990	Nemeth	D19/75

D. 317,409	6/1991	Chiarella	D3/30.1
D. 317,458	6/1991	Sawada et al.	D18/7
4,117,931	10/1978	Berkman	206/387
4,821,882	4/1989	Messina	206/387

Primary Examiner—Bruce W. Dunkins
Assistant Examiner—Martha Thompson
Attorney, Agent, or Firm—Browdy and Neimark

[57] **CLAIM**

The ornamental design for a combined file card holder and calculator, as shown and described.

DESCRIPTION

FIG. 1 is a front elevational view of a combined file card holder and calculator showing my new design in an opened condition;
FIG. 2 is a rear elevational view thereof;
FIG. 3 is a left side elevational view thereof;
FIG. 4 is a right side elevational view thereof;
FIG. 5 is a top plan view thereof;
FIG. 6 is a bottom plan view thereof;
FIG. 7 is a top, right front perspective view drawn to an enlarged scale; and,
FIG. 8 is a top, right front perspective view drawn to an enlarged scale with the lid member in a closed condition.

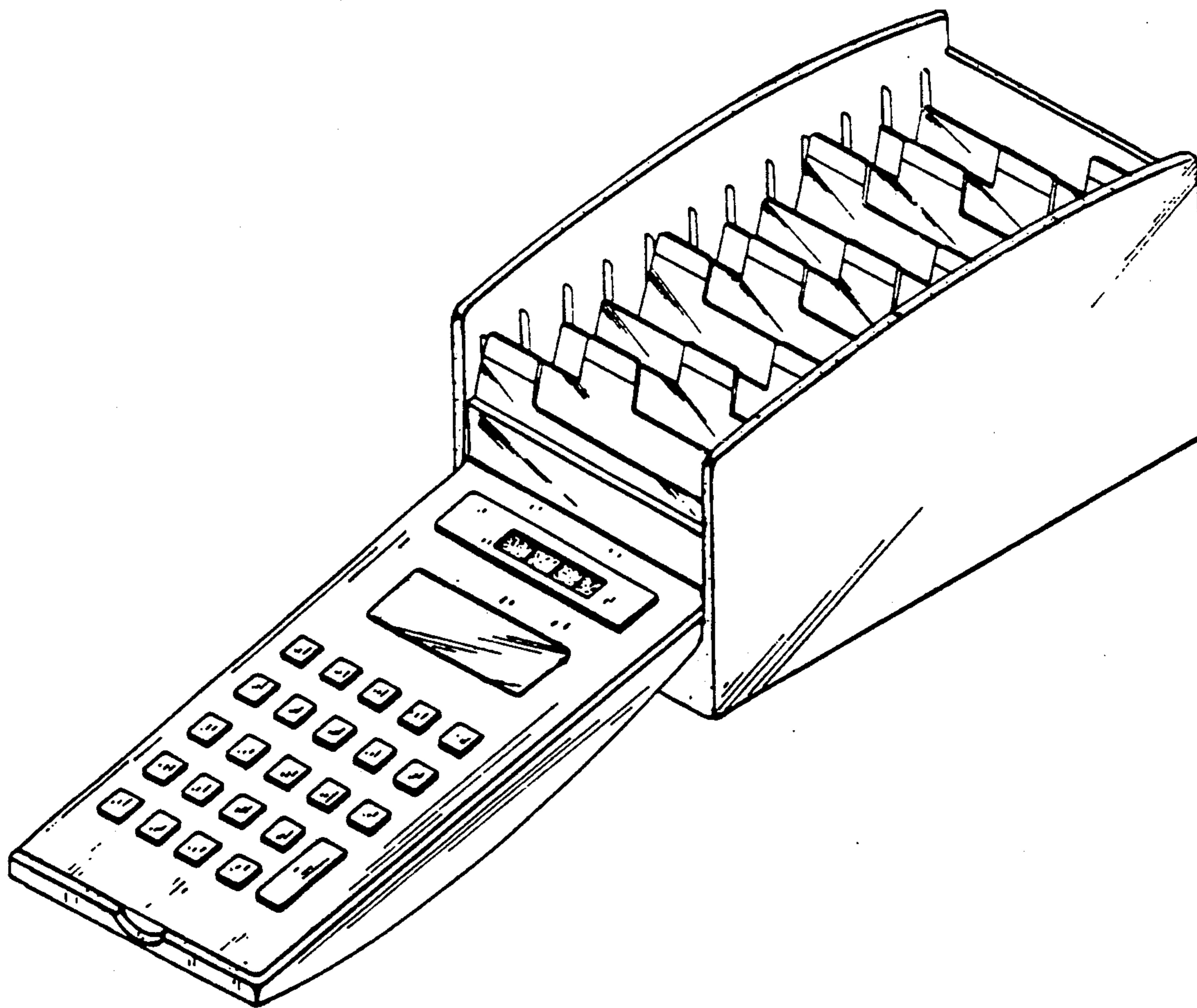

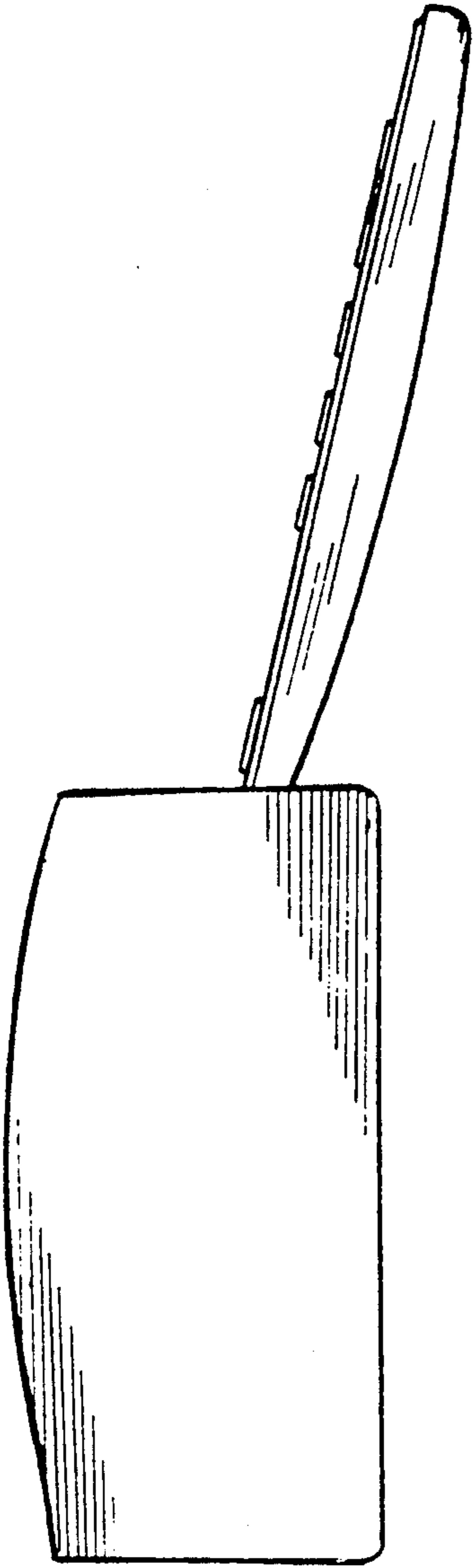

FIG. 3

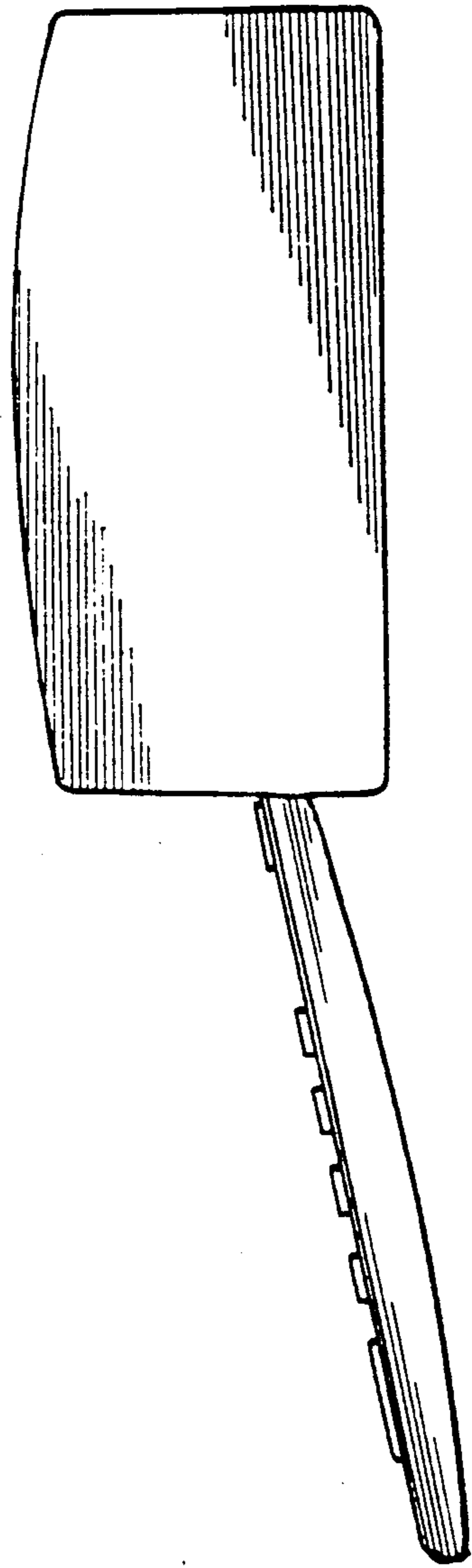

FIG. 4

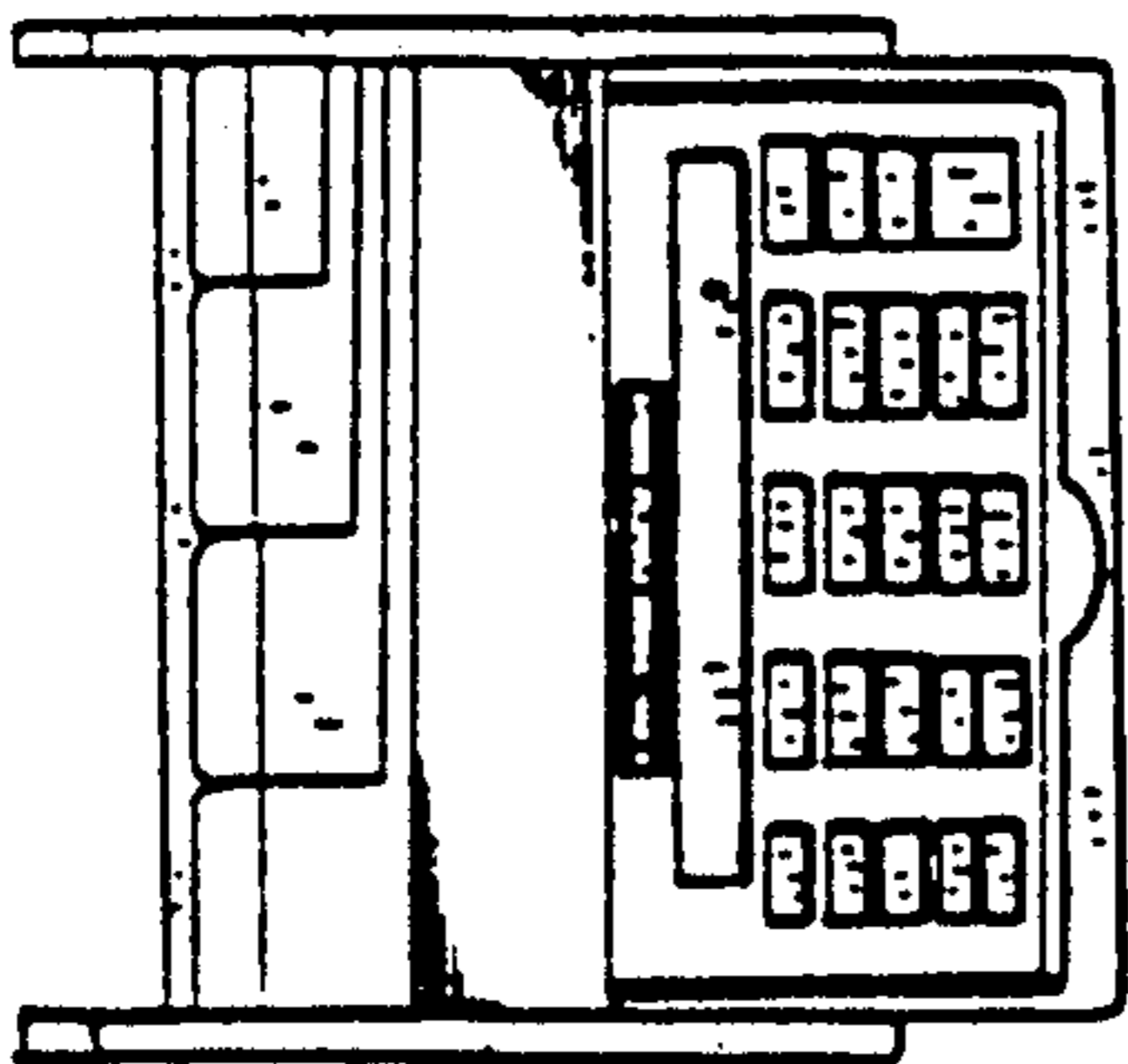

FIG. 1

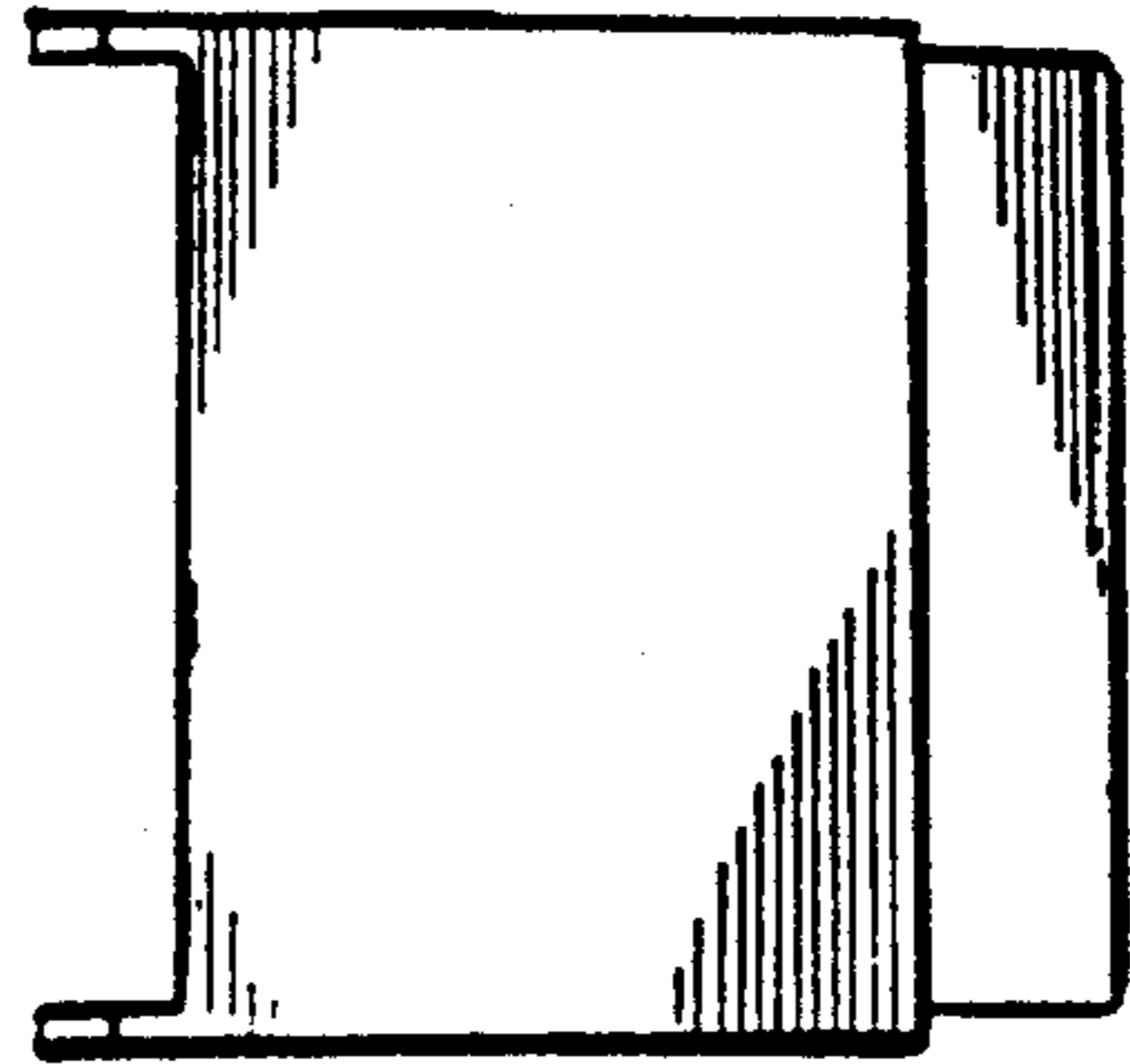

FIG. 2

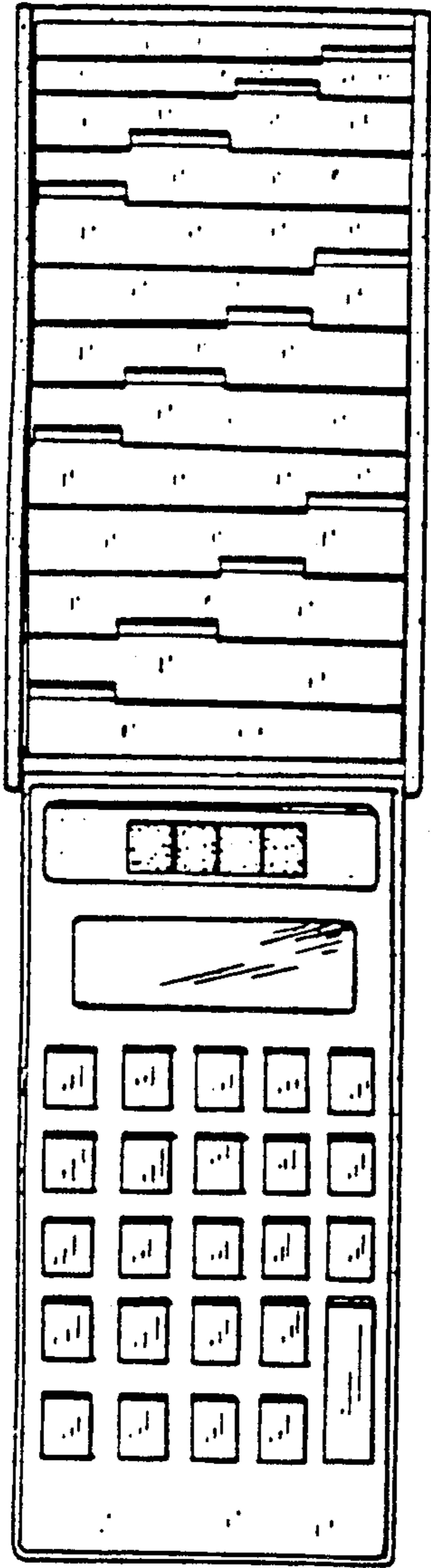

FIG. 5

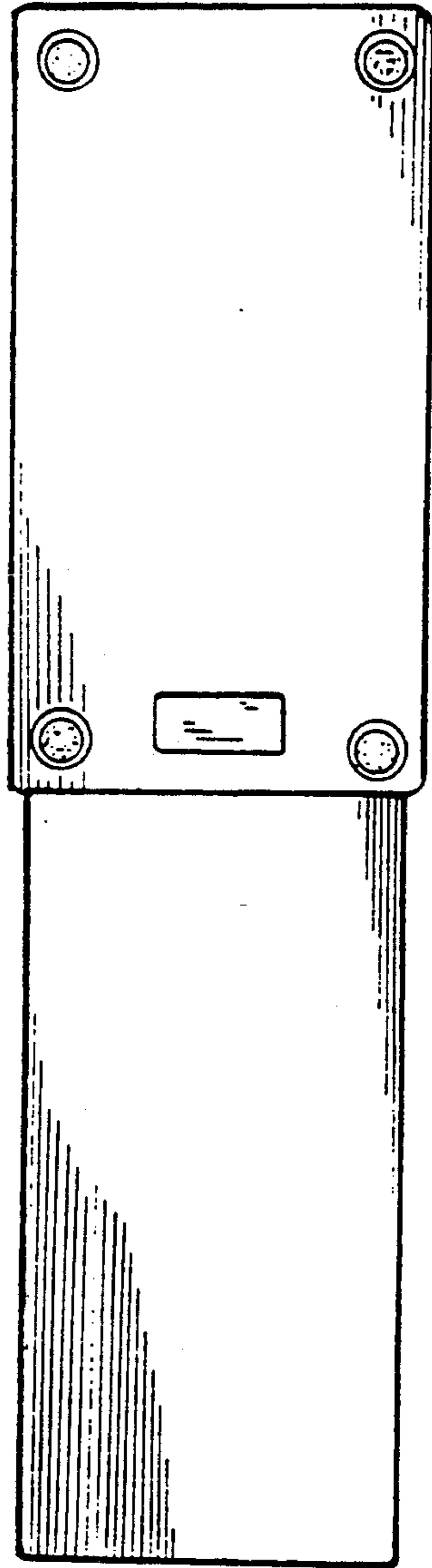

FIG. 6

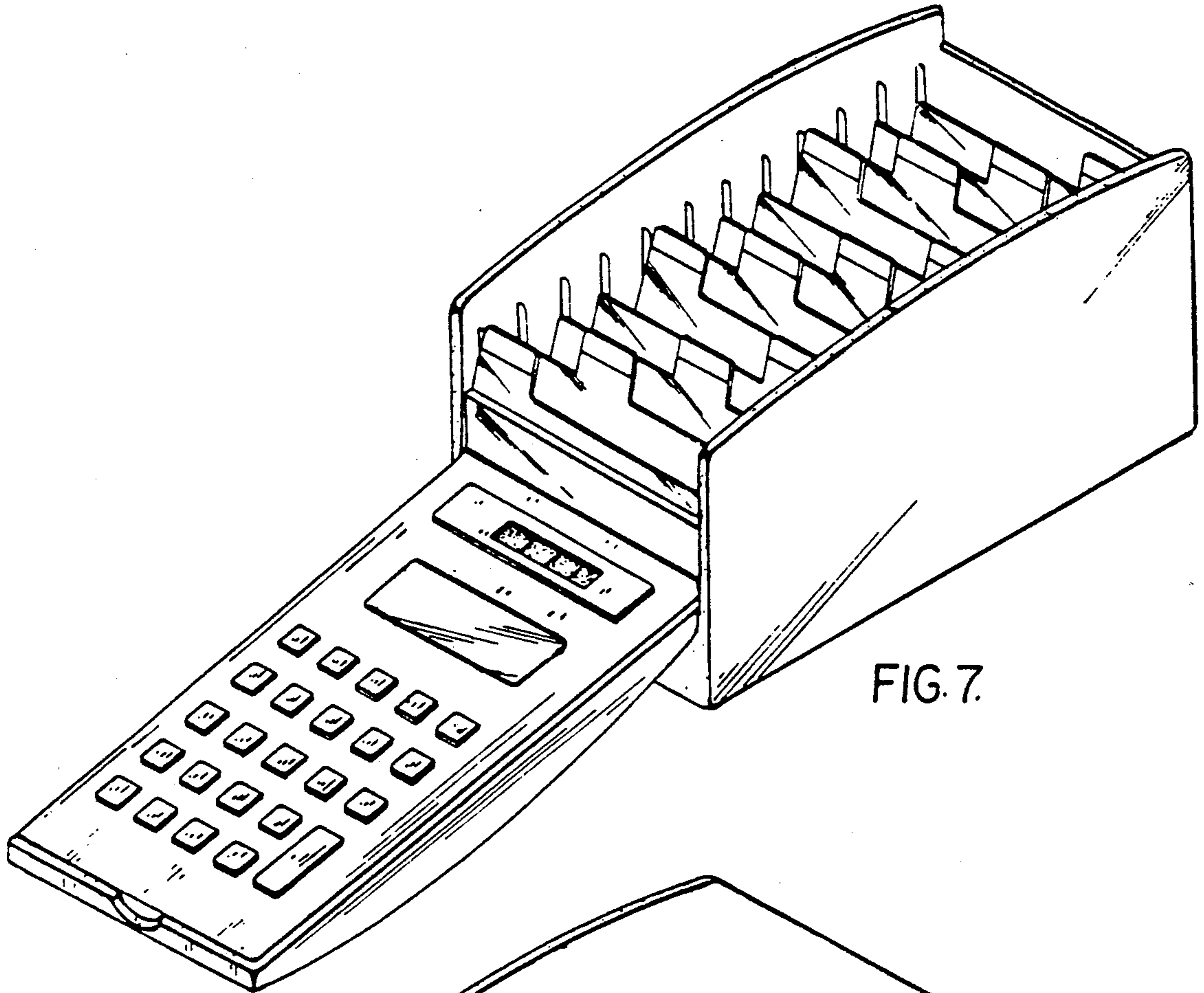

FIG. 7.

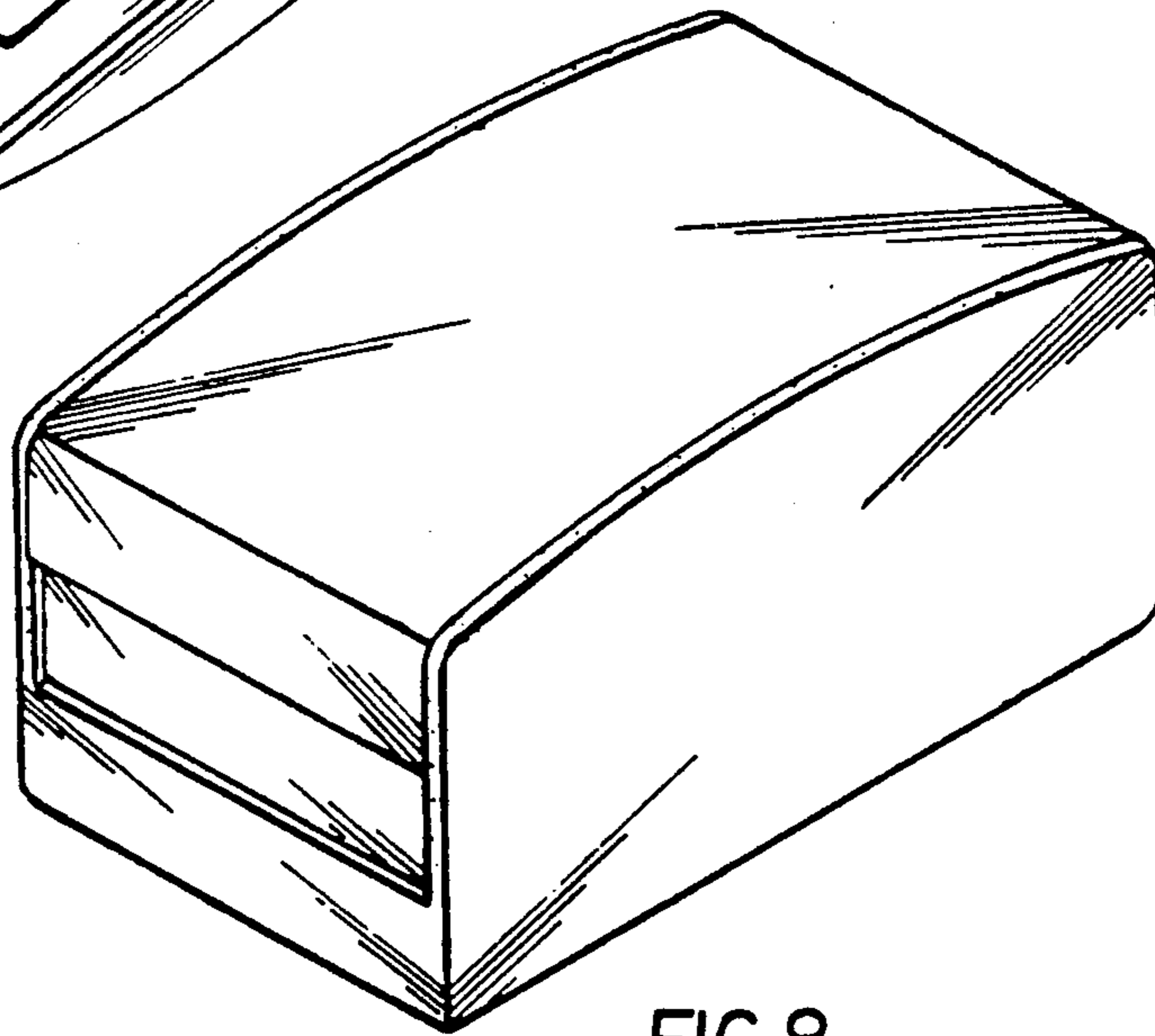

FIG. 8.